

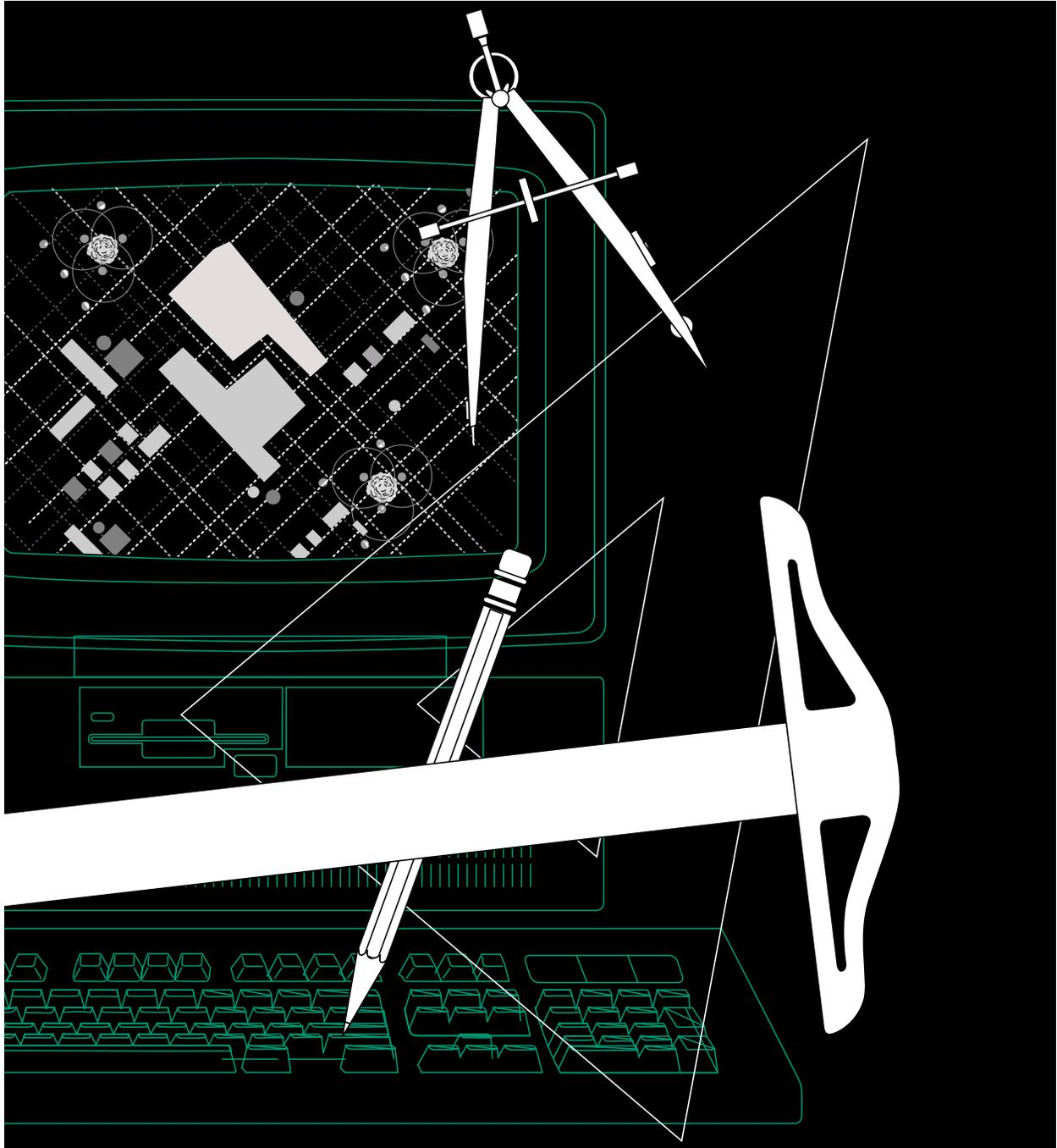

# Landscape Irrigation Design Manual





<b>Forward .....</b>	<b>v</b>
<b>Introduction .....</b>	<b>vii</b>
<b>Step one: Understanding basic hydraulics .....</b>	<b>3</b>
Static water pressure .....	4
Dynamic water pressure .....	6
Exercises on basic hydraulics .....	9
<b>Step two: Obtaining site information .....</b>	<b>13</b>
<b>Step three: Determining irrigation requirements .....</b>	<b>19</b>
Soil type .....	19
Exercises on site information and irrigation requirements .....	23
<b>Step four: Determining water and power supply .....</b>	<b>27</b>
Calculating water meter capacity and working pressure .....	27
Rule number one .....	27
Rule number two .....	28
Rule number three .....	28
Exercises on water capacity and pressure .....	30
<b>Step five: Selecting sprinklers and spacing ranges .....</b>	<b>35</b>
Selecting sprinklers .....	35
Spray sprinklers .....	35
Rotating sprinklers .....	35
Bubblers and drip irrigation devices .....	35
Exercises on selecting sprinklers .....	40
Spacing sprinklers and calculating precipitation rates .....	41
Exercises on spacing sprinklers and calculating precipitation rates .....	47
Locating sprinklers on the plan .....	48
Exercises on locating sprinklers .....	52
<b>Step six: Lateral layout, circuiting sprinklers into valve groups .....</b>	<b>55</b>
Locating valves, main lines and lateral piping .....	57
Calculating lateral operating time .....	58
Sample lateral number 1 .....	59
Sample lateral number 2 .....	59
<b>Step seven: Sizing pipe and valves and calculating system pressure requirements .....</b>	<b>65</b>
Exercises on calculating system pressure requirements .....	71
<b>Step eight: Locating the controller and sizing the valve and power wires .....</b>	<b>75</b>
Locating the controller .....	75
Sizing valve wires .....	75
Sizing power wires .....	78
<b>Step nine: Preparing the final irrigation plan .....</b>	<b>83</b>
Exercises on system electrics and preparing the final irrigation plan .....	85
Irrigation references .....	86

## Contents

<b>Solutions</b> .....	<b>89</b>
Solutions to exercises on basic hydraulics .....	89
Solutions to exercises on site information and irrigation requirements .....	89
Solutions to exercises on water capacity and pressure .....	89
Solutions to exercises on selecting sprinklers .....	90
Solutions to exercises on spacing sprinklers and calculating precipitation rates .....	90
Solutions to exercises on locating sprinklers .....	90
Solutions to exercises on circuit configuration and operating time .....	91
Solutions to exercises on calculating system pressure requirements .....	91
Solutions to exercises on system electrics and preparing the final irrigation plan .....	91
<b>Technical Data</b> .....	<b>94</b>
<b>U.S. Standard Units</b> .....	<b>94</b>
Friction loss characteristics PVC schedule 80 IPS plastic pipe .....	94
Friction loss characteristics PVC schedule 40 IPS plastic pipe .....	95
Friction loss characteristics PVC class 315 IPS plastic pipe .....	96
Friction loss characteristics PVC class 200 IPS plastic pipe .....	97
Friction loss characteristics PVC class 160 IPS plastic pipe .....	98
Friction loss characteristics PVC class 125 IPS plastic pipe .....	99
Friction loss characteristics polyethylene (PE) SDR-pressure-rated tube .....	100
Friction loss characteristics schedule 40 standard steel pipe .....	101
Friction loss characteristics type K copper water tube .....	102
Pressure loss in valves and fittings .....	103
Pressure loss through copper and bronze fittings .....	103
Climate PET .....	103
Estimated service line sizes .....	103
Pressure loss through swing check valves .....	104
Soil characteristics .....	104
Maximum precipitation rates .....	105
Friction loss characteristics of bronze gate valves .....	105
Slope reference .....	105
Pressure loss through water meters AWWA standard pressure loss .....	106
<b>International System Units</b> .....	<b>107</b>
Friction loss characteristics PVC schedule 80 IPS plastic pipe .....	107
Friction loss characteristics PVC schedule 40 IPS plastic pipe .....	108
Friction loss characteristics PVC class 315 IPS plastic pipe .....	109
Friction loss characteristics PVC class 200 IPS plastic pipe .....	110
Friction loss characteristics PVC class 160 IPS plastic pipe .....	111
Friction loss characteristics PVC class 125 IPS plastic pipe .....	112
Friction loss characteristics polyethylene (PE) SDR-pressure-rated tube .....	113
Friction loss characteristics schedule 40 standard steel pipe .....	114
Friction loss characteristics type K copper water tube .....	115
Pressure loss in valves and fittings .....	116
Climate PET .....	116
Estimated service line sizes .....	116
Pressure loss through copper and bronze fittings .....	116
Pressure loss through swing check valves .....	117
Soil characteristics .....	117
Maximum precipitation rates .....	118
Friction loss characteristics of bronze gate valves .....	118
Slope reference .....	118
Pressure loss through water meters AWWA standard pressure loss .....	119
<b>Appendix</b> .....	<b>121</b>
Table of formulas .....	123
Table of figures .....	124
<b>Index</b> .....	<b>129</b>

## ***Forward***

This manual was prepared at the request of numerous individuals who either wished to learn the basic techniques of landscape irrigation design or who are teachers of the subject. Intended as a very basic text for irrigation design, this manual proceeds as if the reader has no prior knowledge in the subject.

As you use this manual, be sure to review the practical exercises at the end of each section. In some cases, new information and tips, not covered in the previous section, are found in the exercises.

The main omission from a design manual such as this is the real, hands-on experience of designing and then installing a landscape irrigation system. The editors of the Landscape Irrigation Design Manual hope such an opportunity is available to you and that the information presented here is of benefit.



## **Introduction**

Properly designed, installed, maintained and managed landscape irrigation systems greatly reduce the volume of irrigation water that is wasted every year. In some water short areas, we have seen the beginnings of planned water conservation efforts. In time, these could become the basis for a coordinated national policy toward water conservation. Today many municipalities require home or business owners to submit irrigation designs for approval prior to construction.

This manual is part of the effort to promote properly designed landscape irrigation systems. It is our goal to present the material as simply as possible while explaining some theory behind the process. Understanding the basic hydraulics material in the first section of the manual is very important, especially to new students of irrigation design. Even intermediate level design students may find it helpful to “brush up” on hydraulics before going on to further studies. With that said, please turn the page to discover some facts about the nature of water.

*Note: Information contained in this manual is based upon generally accepted formulas, computations and trade practices. If any problems, difficulties, or injuries should arise from or in connection with the use or application of this information, or if there is any error herein, typographical or otherwise, Rain Bird Sprinkler Mfg. Corp., and its subsidiaries and affiliates, or any agent or employee thereof, shall not be responsible or liable.*

***Note: Metric data (International System Units) contained in this manual is not always a one-to-one conversion from U.S. measurements (U.S. Standard Units). Some metric data has been altered to simplify examples.***

©2000 Rain Bird Sprinkler Manufacturing Corporation.  
All rights reserved.



# *Understanding Basic Hydraulics*

1

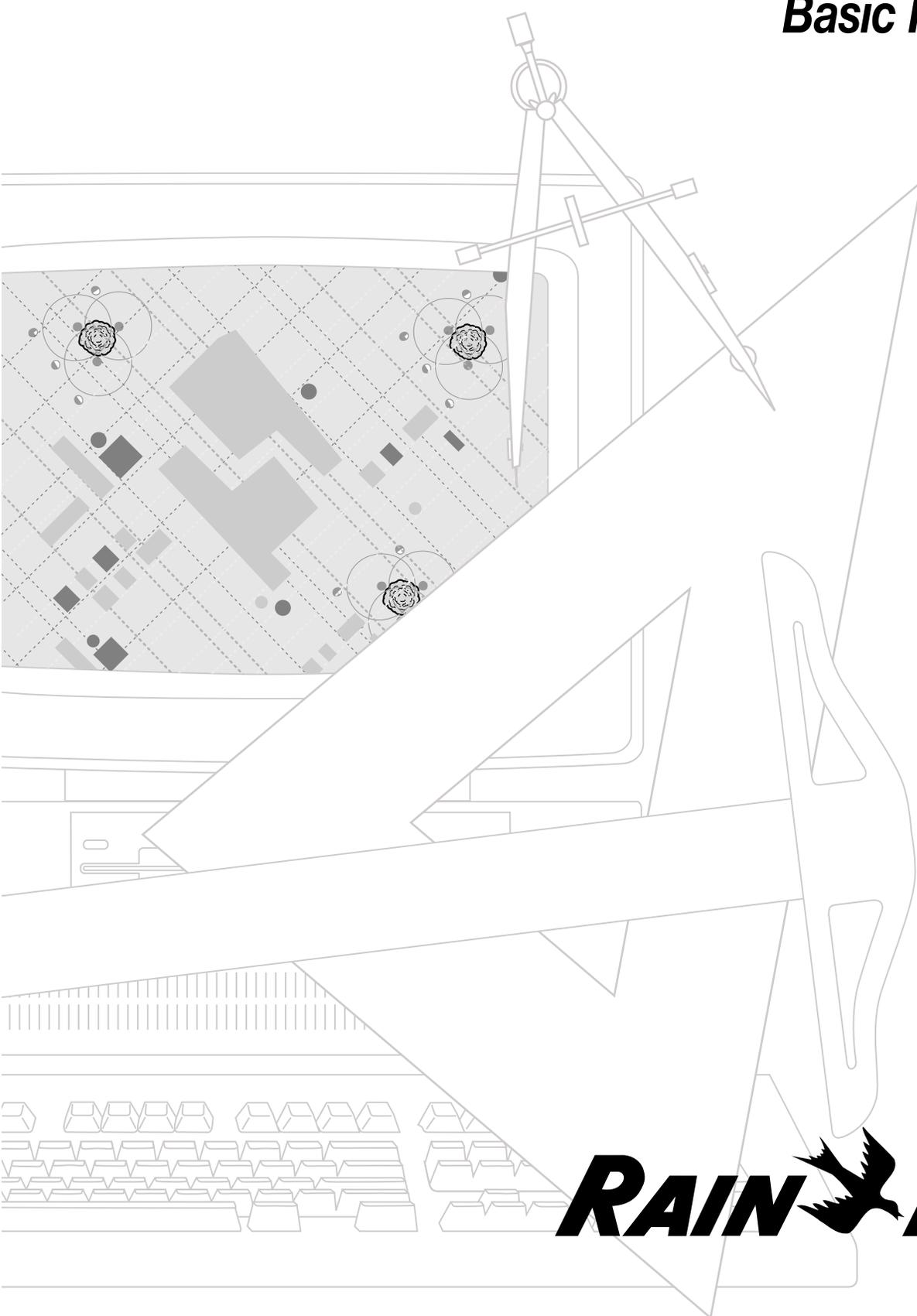

**RAIN  BIRD®**



**Step one: Understanding basic hydraulics**

**Hydraulics** is defined as the study of fluid behavior, at rest and in motion. Properly designed piping, with sound hydraulics, can greatly reduce maintenance problems over the life of an irrigation system. Controlling the water flow velocity, holding velocity within proper limits, reduces wear on the system components and lengthens service life. Poor hydraulic design results in poor performance of the irrigation system, leading to stressed landscaping material, or even broken pipes and flood damage. Lack of design know-how can also cost the system owner more money because the designer may over-design the system to avoid unknown factors. In addition to wasting money, a poor hydraulic design will often waste water. Hydraulic analysis is important to minimize financial risks, produce efficient designs and eliminate waste.

To accomplish all these things we need to understand the nature of water. Water takes the shape of the container. Water is relatively incompressible. Water is also quite heavy — one gallon (one liter) of water weighs 8.3 lbs (1 kg) and water has a specific weight per cubic foot of 62.4 lbs (one ton per cubic meter). Water responds to gravity and seeks its own lowest level (responding to gravity). Water exerts pressure — defined as the force of water exerted over a given area. The formula for water pressure looks like this:

$$P = \frac{\text{force } F}{\text{area } A}$$

- P = pressure in pounds per square inch (kilograms per square centimeter)
- F = force in pounds (kilograms)
- A = area in square inches (square centimeters)

The force is created by the weight of the water above the point where it is being measured. When the area is constant, such as 1 in<sup>2</sup> (1 cm<sup>2</sup>), then the force in pounds (kilograms) is dependent on, simply, the height of the water. The more height to a column of water, the more weight, force, and pressure. Pressure is expressed as pounds per square inch (kilograms per square centimeter) and abbreviated as psi (kg/cm<sup>2</sup> or bar).

A container 1 in<sup>2</sup> (1 cm<sup>2</sup>) and filled with water to a height of 1 ft (50 cm) — the pressure (psi/bar) would equal:

$$P = \frac{W}{A} = \frac{.036 \text{ lb in}^3 \times 12 \text{ in}^3}{1 \text{ in} \times 1 \text{ in}} = \frac{0.433 \text{ lb}}{1 \text{ in}^2}$$

$$\left( \frac{P = W}{A} = \frac{1 \text{ gm/cm}^3 \times 50 \text{ cm}^3}{1 \text{ cm} \times 1 \text{ cm}} = \frac{50 \text{ gm}}{\text{cm}^2} = 0,05 \text{ kg/cm}^2 \right)$$

P = 0.433 psi (0,05 bar)

$$P = \frac{W}{A} = \frac{.036 \text{ lb in}^3 \times 24 \text{ in}^3}{1 \text{ in} \times 1 \text{ in}} = \frac{0.866 \text{ lb}}{1 \text{ in}^2}$$

$$\left( \frac{P = W}{A} = \frac{1 \text{ gm/cm}^3 \times 100 \text{ cm}^3}{1 \text{ cm} \times 1 \text{ cm}} = \frac{100 \text{ gm}}{\text{cm}^2} = 0,10 \text{ kg/cm}^2 \right)$$

P = 0.866 psi (0,1 bar)

Consider a 1 in<sup>2</sup> (1 cm<sup>2</sup>) container filled with water to a depth of 1 ft (50 cm). One foot (50 cm) of water creates a pressure of .433 psi (0,05 bar) at the base of the container. It makes no difference if the 1 ft (50 cm) of water is held in this narrow container or at the bottom of a 1 ft (50 cm) deep lake. The area we are concerned with is only 1 in<sup>2</sup> (1 cm<sup>2</sup>) at the bottom of either container.

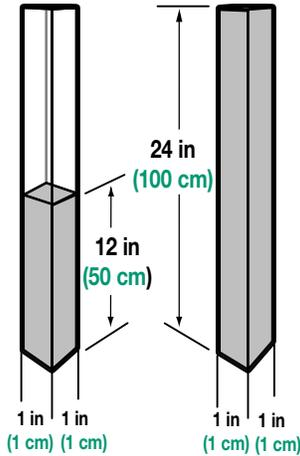

Figure 1: Water towers filled at 12 in and 24 in (50 cm and 100 cm)

If you double the height of the water, the pressure is doubled.  
 .433 x 2 ft of height = .866 psi  
 0,05 bar x 2 = 0,1 bar

This relationship between pressure and elevation is known as “feet of head” (meters of head). By using this conversion factor, we can easily determine the static (no flow) water pressure within any pipe.

The factors for converting pressure to feet of head (meters of head) and feet of head (meters of head) back to pressure are both multipliers. To convert feet of head to pressure in

## Understanding Basic Hydraulics

psi, multiply the feet by .433. One foot of water = .433 psi. For example, 200 ft of water height x .433 produces 86.6 psi at its base. (To convert meters of head to pressure in kg/cm<sup>2</sup>, divide the meters by 10. One meter of water = 0,1 kg/cm<sup>2</sup>. For example, 100 meters of water x 0,1 kg/cm<sup>2</sup> = 10kg/.cm<sup>2</sup> or 10 bar of pressure at its base.) Further, using this factor we can determine that a water tower with a water surface 200 ft (100 m) above the point where we need it would create a pressure of 86.6 psi (10 bar).

To convert pressure in psi to feet of head, multiply the pressure by 2.31. One psi = 2.31 ft of water. For example, 100 psi x 2.31 = 231 feet of head. (To convert pressure in bar or kg/cm<sup>2</sup> to meters of head, multiply the pressure by 10. 1 kg/cm<sup>2</sup> = 10 meters of water = 1 bar. For example, 10 kg/cm<sup>2</sup> = 100 meters of head.)

Calculating with this factor in advance, we would know that we can't pump water up into a lake that is 300 ft (200 m) above our water source if we had a pumping water pressure available of 100 psi (10 bar). Pressure of 100 psi (10 bar) would only lift the water 231 ft (100 m).

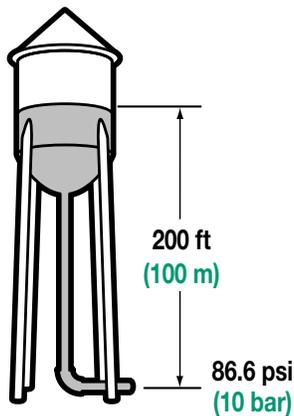

Figure 2: Water tower – 200 ft (100 m)

The word **hydrostatic** refers to the properties of water at rest. We will be discussing static water pressure as a starting point for hydraulic design of an irrigation system.

**Hydrodynamic** refers to the properties of water in motion. Moving water, at the correct flow and pressure, to where it's needed is the hydraulic basis of irrigation design. Static water pressure refers to the pressure of a closed system with no water moving. A water-filled main line, with all valves closed, would experience full static pressure with only pressure variation due to elevation. Static water pressure is an indication of the potential pressure available to operate a system.

### Static water pressure

There are two ways to create static water pressure. As we have seen in our discussion regarding the relationship between pounds per square inch (bar) and elevation, water height can create pressure. By elevating water in tanks, towers and reservoirs, above where the water is needed, static pressure is created. Water systems may also be pressurized by a pump or a pump can be used to increase, or boost, pressure. Whether from elevation differences or by mechanical means, understanding the static pressure at the water source for an irrigation system is where hydraulic calculations begin.

Here is an example of a simple system for supplying water to a house from a city main line. We will be following the complete irrigation design process for this project throughout the manual.

The supply system to this home looks like this (see Figure 3): at point "A," under the street at a depth of 4 ft (1,2 m), is the city water main with a fairly high static pressure of 111 psi (7,7 bar). From the main line there is a supply pipe made of 1-1/2 in (40 mm) copper that rises 3 ft (1 m) to

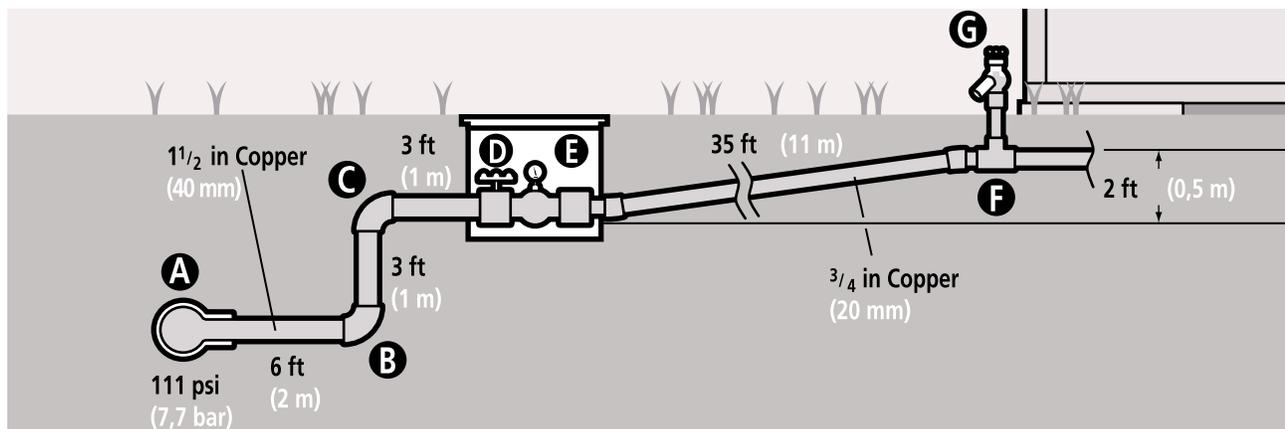

Figure 3: Water supply to a house

connect to the meter and is 12 ft (4 m) in length. At the curb side is an existing 3/4 in (20 mm) size water meter. Connected to the meter is a 3/4 in (20 mm) copper service line that runs 35 ft (11 m) to where it enters the house through the garage. There is a small rise in elevation of 2 ft (0,5 m) from the meter location to the house. Finally, 1 ft (0,3 m) above the point where the service line enters the house is a hose valve connection.

To calculate the static water pressure available to the site, we start at point “A” where the water purveyor advises that we can expect a static pressure in their main line of 111 psi (7,7 bar). Point “B” in this diagram is at the same elevation as the main line and has the same 111 psi (7,7 bar) pressure. Point “C” is 3 ft (1 m) above the main and we would calculate the pressure at point “C” as follows:  $3 \text{ ft} \times .433 \text{ psi} = 1.299 \text{ psi}$  ( $1 \text{ m} \div 10 = 0,1 \text{ bar}$ ), or for simplification, 1.3 psi (0,1 bar). Since the supply source is from below, the 1.3 psi (0,1 bar) is a weight against the source pressure, so it is a loss. Therefore, the static pressure at point “C” is  $111 \text{ psi} - 1.3 \text{ psi}$  ( $7,7 \text{ bar} - 0,1 \text{ bar}$ ) for a remainder of 109.7 psi (7,6 bar).

Points “D” and “E,” which are on each side of the meter, are on the same elevation as point “C,” so they have the same 109.7 psi (7,6 bar) static pressure. Between points “E” and “F” there is a 2 ft (0,5 m) rise in elevation that we calculate as follows to get a static pressure for point “F:”

$$2 \times .433 \text{ psi} = .866 \text{ psi}$$

$$(0,5 \div 10 = 0,05 \text{ bar})$$

$109.7 \text{ psi} - .866 \text{ psi} = 108.8 \text{ psi}$ , the static pressure remaining at point “F”. ( $7,6 \text{ bar} - 0,05 \text{ bar} = 7,55 \text{ bar}$ )

Point “G,” the hose bib in the garage, is 1 ft (0,3 m) above point “F” for which we would calculate the static pressure by subtracting .433 psi (0,03 bar) from the 108.8 psi (7,55 bar) at point “F” to determine there is approximately 108.36 psi (7,52 bar) at point “G.” A more direct way to calculate the static pressure for point “G” would be to multiply the 6 ft rise in elevation by .433 psi (divide the 2 m rise by 10) and subtract the 2.6 psi (0,2 bar) answer from 111 psi (7,7 bar) for a remainder of 108.4 psi (7,5 bar) in rounded numbers.

The designer may choose to cut (or tap) into the service line anywhere between the meter and the house to start the main line for the irrigation system. (The location of the tap into the service line may also be referred to as the point-of-connection or POC.) At any point along the main line, the static pressure can be calculated.

In this case, the designer will need to consider and control the high water pressure condition on this site. Had the

pressure in the city main been low, say 40 psi (2,8 bar), the designer would adjust the design and equipment selection to provide a system that operates correctly even with the low service line pressure. In some instances, the water pressure is too low for typical landscape irrigation requirements and a booster pump will be necessary.

If the water main was in a street higher than the site, all the elevation change coming down to the project would have produced pressure gains instead of losses. For example, had the main line been located 10 ft (3 m) above the site, the static pressure at the hose bib would have been:

$$10 \text{ ft} \times .433 \text{ psi} = 4.33 \text{ psi} + 111 \text{ psi static pressure in the main line} = 115.33 \text{ psi static pressure at the valve}$$

$$(3 \text{ m} \div 10 = 0,3 \text{ bar} + 7,7 \text{ bar static pressure in the main line} = 8,0 \text{ bar static pressure at the valve})$$

To begin an irrigation system design you must have critical data or make critical assumptions about the water source. Static water pressure at the point-of-connection is a necessary part of the data needed to start an irrigation system design.

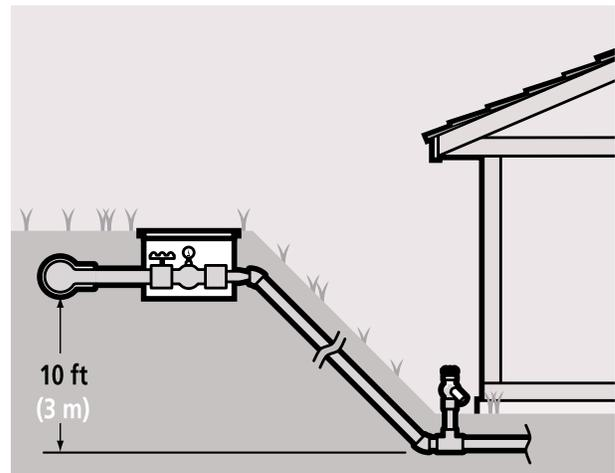

Figure 4: Static water pressure

A sound irrigation design cannot begin with subjective terms like “good pressure,” or “high pressure.” When gathering information at a project site, a water pressure reading or valid pressure assumption is very important.

In the previous example, the designer or other person gathering the site data could have measured the water pressure with a pressure gauge rather than using the water purveyor’s estimate. However, it is important to design the irrigation system for the “worst case” pressure conditions. In most locales, the “worst case” situation will be on hot weekend days in the summer when a lot of people irrigate

## Understanding Basic Hydraulics

their lawns. The water purveyor probably uses a computer model to predict the lower summer pressures in their system, so they can provide data regardless of the season. The water purveyor may also be able to predict if pressures may change in the future. For example, they may be planning to install a new pump to increase pressure or conversely, the additional houses to be built in the future may cause the pressure to be lower. Good advice can generally be obtained from the professionals working for the water purveyor, and it is good to call them even if a pressure reading is made at the site.

The pressures calculated in the previous example were all static water pressures with no water movement in the system. When a valve is opened, and water in the system begins flowing, we have a new pressure situation to take into account. Friction loss is a pressure loss caused by water flowing through pipes, fittings, and components in the system. Pipes, fittings, valves, water meters and backflow prevention devices all offer resistance to water flowing, and the resistance creates a pressure loss. The roughness and turbulence on the inside surfaces of pipes and components creates a drag or friction on the passing water, which causes the pressure of the flowing water to decrease.

### Dynamic water pressure

Dynamic water pressure or “working pressure” differs from static pressure because it varies throughout the system due to friction losses, as well as elevation gains or losses. The dynamic water pressure is the pressure at any point in the system considering a given quantity of water flowing past that point.

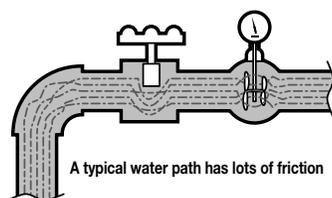

Figure 5: Water path with friction

The amount of water flowing through the components of the system also affects the friction loss. The more water being forced through the system, the higher the flow velocity, and the higher the pressure loss. Because of this, the physical size of the water path through a component also determines how much pressure is lost. A sprinkler equipment manufacturer’s catalog contains flow loss charts for each piece of water-handling equipment and for each size in which they are available. Larger sizes are for larger flow ranges within each equipment series.

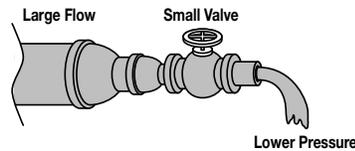

Figure 6: Large flow, small valve, lower pressure

Pipe flow loss charts are available for quickly determining the pressure loss at particular flows, in gallons per minute (gpm), meters cubed per hour (m<sup>3</sup>/h) or liters per second (L/s), through various types and sizes of pipe. This flow loss is usually given as pounds per square inch (bar) loss per 100 ft (100 m) of pipe. The loss varies with differing types of pipe; different pipes have varying dimensions and degrees of internal smoothness. This fact makes each type of pipe hydraulically unique.

In addition to the pound per square inch loss per 100 ft (bar loss per 100 m), friction loss charts will often show the velocity of the water passing through the pipe at that flow rate.

**Velocity**, the rate at which water moves within the components of the system, is an important factor to understand. The faster the water moves through a pipe, the higher the friction loss. Fast moving water can cause other problems in a system as well.

The industry has established 5 ft/s (1,5 m/s) as an acceptable maximum velocity. Velocities less than 5 ft/s (1,5 m/s) are less likely to cause damaging surge pressures. Also, pressure losses due to friction increase rapidly as velocities increase beyond 5 ft/s (1,5 m/s).

In addition to checking a pipe chart to find velocity for a certain type and size of pipe at a given flow, you can use an equation to determine flow mathematically. The formula is:

$$V = \frac{\text{gpm}}{2.45 \times \text{dia}^2} \left( V = \frac{1273,24 \times \text{L/s}}{\text{dia}^2} \right)$$

V = velocity in feet per second (meters per second)

dia = inside diameter of pipe in inches (millimeters)

One example in your manual is for 1/2 in (15 mm) Schedule 40 PVC pipe with a flow of 10 gpm (0,63 L/s). By squaring the inside diameter of the pipe, .622 in, and multiplying the product by 2.45 and then dividing that answer into 10 gpm, we arrive at 10.5 ft/s. (By multiplying 0,63 L/s by 1273,24 and then dividing by the diameter squared, we arrive at 3,57 m/s.) It’s much easier to get this information from the pipe chart.

Turn to page 95 (U.S. Standard Units) or 108 (International System Units) of the Technical Data section of this manual and look at the friction loss characteristics chart for Schedule 40 PVC pipe (shown below). This is a typical chart showing the losses through various sizes of Schedule 40 PVC pipe across a wide range of flows. Across the top of the chart find pipe sizes beginning on the left with 1/2 in (15 mm) size and running across the page to 6 in (160 mm) size on the right.

## PVC SCHEDULE 40 IPS PLA

(1120, 1220) C=150  
PSI loss per 100 feet of pipe (psi/100 ft)

### PVC CLASS 40 IPS PLASTIC PIPE

Sizes 1/2 in through 6 in. Flow 1 through 600 gpm.

SIZE	1/2 in	3/4 in	1 in	1 1/4 in	1 1/2 in
OD	0.840	1.050	1.315	1.660	1.9C
ID	0.622	0.824	1.049	1.380	1.61
Wall Thk	0.109	0.113	0.133	0.140	0.14

flow gpm	velocity fps	psi loss	velocity fps	psi loss	velocity fps	psi loss	velocity fps	psi loss	velocity fps
1	1.05	0.43	0.60	0.11	0.37	0.03	0.21	0.01	0.15
2	2.11	1.55	1.20	0.39	0.74	0.12	0.42	0.03	0.31
3	3.16	3.28	1.80	0.84	1.11	0.26	0.64	0.07	0.47
4	4.22	5.60	2.40	1.42	1.48	0.44	0.85	0.12	0.62
5	5.27	8.46	3.00	2.15	1.85	0.66	1.07	0.18	0.78
6	6.33	11.86	3.60	3.02	2.22	0.93	1.28	0.25	0.94
7	7.38	15.77	4.20	4.01	2.59	1.24	1.49	0.33	1.10
8	8.44	20.20	4.80	5.14	2.96	1.59	1.71	0.42	1.25
9	9.49	25.12	5.40	6.39	3.33	1.97	1.92	0.52	1.41
10	10.55	30.54	6.00	7.77	3.70	2.40	2.14	0.63	1.57
11	11.60	36.43	6.60	9.27	4.07	2.86	2.35	0.75	1.73
12	12.65	42.80	7.21	10.89	4.44	3.36	2.57	0.89	1.88
14	14.76	56.94	8.41	14.48	5.19	4.47	2.99	1.18	2.20
16	16.87	72.92	9.61	18.55	5.93	5.73	3.42	1.51	2.51
18	18.98	90.69	10.81	23.07	6.67	7.13	3.85	1.88	2.83
20	21.09	110.23	12.01	28.04	7.41	8.66	4.28	2.28	3.14
22			13.21	33.45	8.15	10.33	4.71	2.72	3.46
24			14.42	39.30	8.89	12.14	5.14	3.20	3.77
26			15.62	45.58	9.64	14.08	5.57	3.17	4.09

Figure 7: Schedule 40 PVC pipe friction loss characteristics (partial)  
Please see page 108 for a metric version of the chart above.

In the columns on the far right and left of the chart are the flows in gallons per minute (meters cubed per hour or liters per second) with the lowest flow at the top and increasing flows as you read down the chart. Two columns of data are given for each size of pipe listed. The first column shows the velocity in feet per second (meters per second). Read down the left-hand column for flow to 10 gpm (2,27 m<sup>3</sup>/h or 0,63 L/s) and then read across to the first column under the 1/2 in (15 mm) size. 10.55 ft/s (3,22 m/s) is the velocity of the water for 1/2 in (15 mm) Schedule 40 PVC pipe when flowing 10 gpm (2,27 m<sup>3</sup>/h or 0,63 L/s). This is the same velocity we calculated with the velocity formula.

The other column under each pipe size on the chart contains the friction loss data in pounds per square inch (bar) lost per 100 ft (100 m) of pipe. Using the same flow of 10 gpm (2,27 m<sup>3</sup>/h or 0,63 L/s) in the leftmost column, read

across to the friction loss number under the 1/2 in (15 mm) size pipe. 30.54 psi (6,90 bar) would be lost for every 100 ft (100 m) of 1/2 in (15 mm) Schedule 40 PVC pipe at a flow of 10 gpm (2,27 m<sup>3</sup>/h or 0,63 L/s). Looking across to the 1 in (25 mm) size pipe, at the same 10 gpm (2,27 m<sup>3</sup>/h or 0,63 L/s) flow, we read a pound per square inch (bar) loss of only 2.4 per 100 ft (0,5 bar per 100 m). As you can see, pipe size can make a big difference in controlling friction loss.

There is another important indicator on the friction loss chart. The shaded area that runs diagonally across the face of the chart shows where the flows cause velocities to exceed 5 ft/s (1,5 m/s).

For example, the 10 gpm (2,27 m<sup>3</sup>/h or 0,63 L/s) flow in 1/2 in (15 mm) Schedule 40 is deep within the shaded area. We already know that a 10 gpm (2,27 m<sup>3</sup>/h or 0,63 L/s) flow in this 1/2 in (15 mm) pipe creates a velocity of more than 10 ft/s (3,05 m/s). According to the 5 ft/s (1,5 m/s) rule, we would not try to force 10 gpm (2,27 m<sup>3</sup>/h or 0,63 L/s) flow through 1/2 in (15 mm) Schedule 40 PVC pipe. But, look over at 1 in (25 mm) for the same flow. Ten gpm (2,27 m<sup>3</sup>/h or 0,63 L/s) is above the shaded area for 1 in (25 mm) and is well below 5 ft/s (1,5 m/s) velocity. The maximum 5 ft/s (1,5 m/s) rule is one factor used to size pipe in a sprinkler system. We will discuss pipe sizing later in this manual.

If we wanted to determine the friction loss through 50 ft (50 m) of 1 in (25 mm) Class 200 PVC pipe flowing at 16 gpm (3,63 m<sup>3</sup>/h or 1,01 L/s), we would first turn to the pipe chart for that type of pipe.

Turn to the class 200 PVC chart and read down the leftmost column to 16 gpm (3,63 m<sup>3</sup>/h or 1,01 L/s) flow. Read across to the second column under the 1 in (25 mm) size. The loss per 100 ft is 3.11 psi (loss per 100 m is 0,70 bar). Because we want to know the loss for only 50 ft (50 m) of that pipe we would simply multiply 3.11 psi x .5 (0,70 bar x 0,5) and get a total loss of about 1.55 psi (0,35 bar). We also know that the flow velocity is under our 5 ft/s (1,5 m/s) limit because it is not in the shaded area.

## PVC CLASS 200 IPS PLASTIC PIPE

(1120, 1220) SDR 21 C=150  
PSI loss per 100 feet of pipe (psi/100 ft)

### PVC CLASS 200 IPS PLASTIC PIPE

Sizes 3/4 in through 6 in. Flow 1 through 600 gpm.

SIZE	3/4 in	1 in	1 1/4 in	1 1/2 in	2 in
OD	1.050	1.315	1.660	1.900	2.375
ID	0.930	1.189	1.502	1.720	2.149
Wall Thk	0.060	0.063	0.079	0.090	0.113

flow gpm	velocity fps	psi loss	velocity fps	psi loss	velocity fps	psi loss	velocity fps	psi loss	velocity fps	psi loss	velocity fps	psi loss
1	0.47	0.06	0.28	0.02	0.18	0.01	0.13	0.00				
2	0.94	0.22	0.57	0.07	0.36	0.02	0.27	0.01	0.17	0.00		
3	1.42	0.46	0.86	0.14	0.54	0.04	0.41	0.02	0.26	0.01	0.1	
4	1.89	0.79	1.15	0.24	0.72	0.08	0.55	0.04	0.35	0.01	0.2	
5	2.36	1.20	1.44	0.36	0.90	0.12	0.68	0.06	0.44	0.02	0.3	
6	2.83	1.68	1.73	0.51	1.08	0.16	0.82	0.08	0.53	0.03	0.3	
7	3.30	2.23	2.02	0.67	1.26	0.22	0.96	0.11	0.61	0.04	0.4	
8	3.77	2.85	2.30	0.86	1.44	0.28	1.10	0.14	0.70	0.05	0.4	
9	4.25	3.55	2.59	1.07	1.62	0.34	1.24	0.18	0.79	0.06	0.5	
10	4.72	4.31	2.88	1.30	1.80	0.42	1.37	0.22	0.88	0.07	0.6	
11	5.19	5.15	3.17	1.56	1.98	0.50	1.51	0.26	0.97	0.09	0.6	
12	5.66	6.05	3.46	1.83	2.17	0.59	1.65	0.30	1.06	0.10	0.7	
14	6.60	8.05	4.04	2.43	2.53	0.78	1.93	0.40	1.23	0.14	0.8	
16	7.55	10.30	4.61	3.11	2.89	1.00	2.20	0.52	1.41	0.17	0.9	
18	8.49	12.81	5.19	3.87	3.25	1.24	2.48	0.64	1.59	0.22	1.0	
20	9.43	15.58	5.77	4.71	3.61	1.51	2.75	0.78	1.76	0.26	1.2	
22	10.38	18.58	6.34	5.62	3.97	1.80	3.03	0.93	1.94	0.32	1.3	
24	11.32	21.83	6.92	6.60	4.34	2.12	3.30	1.09	2.12	0.37	1.4	
26	12.27	25.32	7.50	7.65	4.70	2.46	3.58	1.27	2.29	0.43	1.5	
28	13.21	29.04	8.08	8.78	5.06	2.82	3.86	1.46	2.47	0.49	1.6	
30	14.15	33.00	8.65	9.98	5.42	3.20	4.13	1.66	2.65	0.56	1.8	
35	16.51	43.91	10.10	13.27	6.32	4.26	4.82	2.20	3.09	0.75	2.1	
40	18.87	56.23	11.54	17.00	7.23	5.45	5.51	2.82	3.53	0.95	2.4	
45			12.98	21.14	8.13	6.78	6.20	3.51	3.97	1.19	2.7	
50			14.42	25.70	9.04	8.24	6.89	4.26	4.41	1.44	3.0	
55			15.87	30.66	9.94	9.83	7.58	5.09	4.85	1.72	3.3	
60			17.31	36.02	10.85	11.55	8.27	5.97	5.30	2.02	3.6	
65			18.75	41.77	11.75	13.40	8.96	6.93	5.74	2.35	3.9	
70					12.65	15.37	9.65	7.95	6.18	2.69	4.2	
75					13.56	17.47	10.34	9.03	6.62	3.06	4.5	

Figure 8: Class 200 PVC pipe friction loss characteristics (partial)  
Please see page 110 for a metric version of the chart above.

Now that you know how to calculate static pressure changes due to differing elevations and how to read a pipe chart to determine friction losses, turn to the next page in the manual and do the exercises for both static and dynamic conditions. When you complete the exercises you can check your work in the Solutions section on page 87.

## Exercises on basic hydraulics

Using the diagram below of an elevated water tank and its piping system, fill in the blanks in the hydraulic analysis.

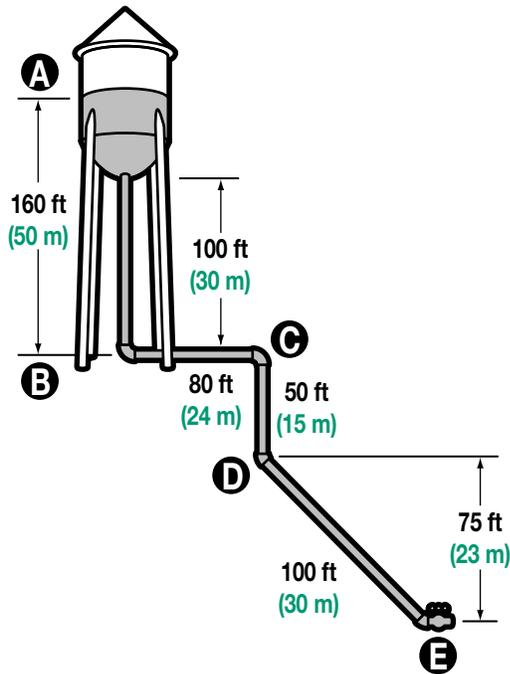

- A. Point B in the system is 160 ft (50 m) below the water's surface at point A. To find the static water pressure in pounds per square inch (bar) at point B you would multiply by \_\_\_\_\_ and get an answer of \_\_\_\_\_ psi (divide by \_\_\_\_\_ and get an answer of \_\_\_\_\_ bar).
- B. Points B and C are on the same elevation. How many pounds per square inch (bar) difference is there in the static pressure at these two points?
- C. What is the static pressure at the following points?  
 Point D \_\_\_\_\_  
 Point E \_\_\_\_\_
- D. All the pipe in the system is 1-1/4 in (32 mm) Class 200 PVC. Answer the questions below for a system flow of 26 gpm (5,9 m<sup>3</sup>/h or 1,64 L/s).  
 Point B had a static pressure of \_\_\_\_\_ psi (bar). After you subtract the friction loss caused by the above flow through 100 ft (30 m) of 1-1/4 in (32 mm) Class 200 PVC pipe the dynamic pressure at B is \_\_\_\_\_ psi (bar).

Keep in mind that dynamic pressure is a running total of friction losses and elevation losses or gains.

Starting with point B's dynamic pressure, answer the following:

Point C's dynamic pressure is \_\_\_\_\_ psi (bar).

Point D's dynamic pressure is \_\_\_\_\_ psi (bar).

Point E's dynamic pressure is \_\_\_\_\_ psi (bar).

- E. If the 100 ft (30 m) section of pipe between points D and E angled up 75 ft (23 m) in elevation instead of down, point E's dynamic pressure would be \_\_\_\_\_ psi (bar).



# Obtaining Site Information

2

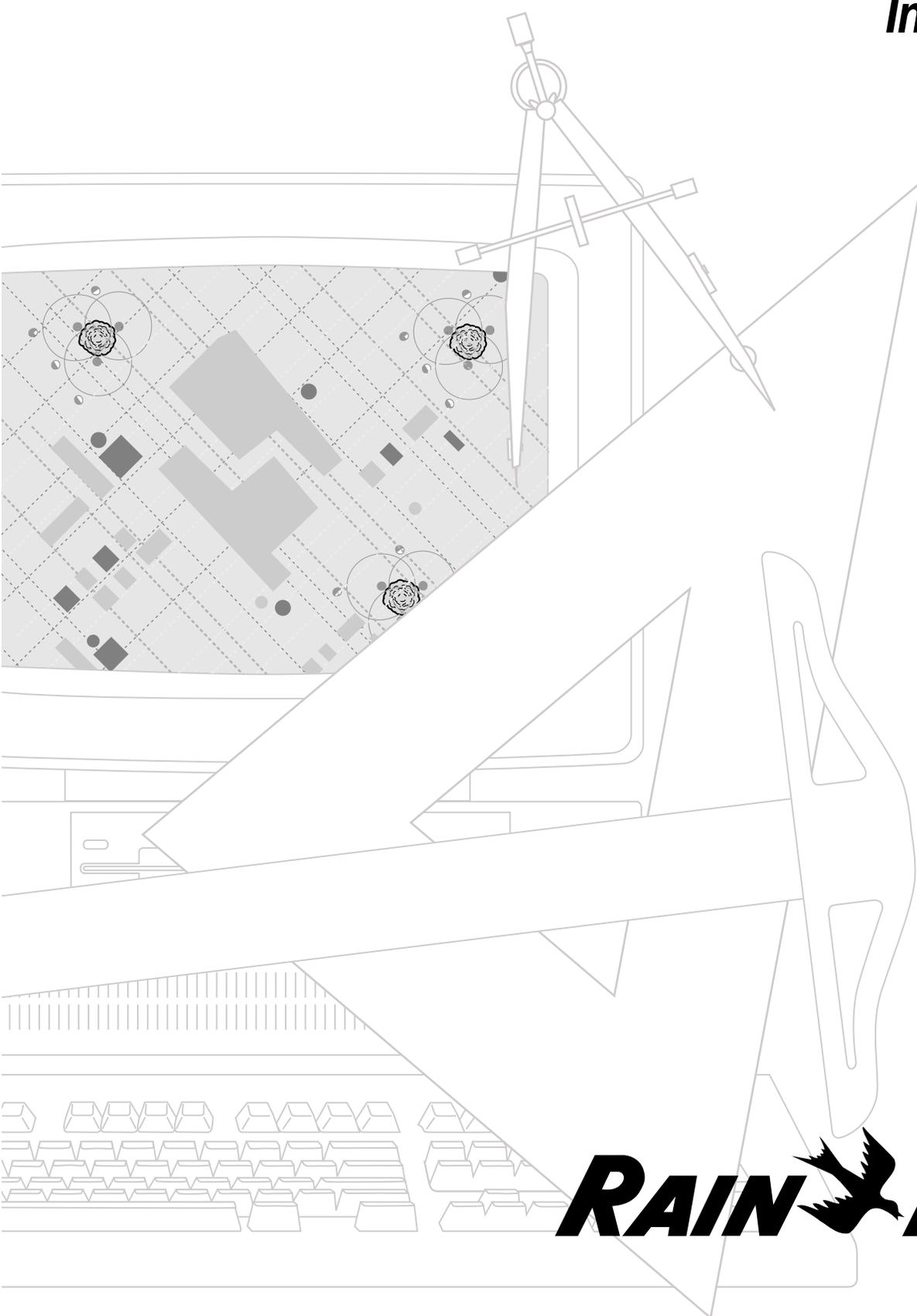

**RAIN**  **BIRD**®



## **Step two: Obtaining site information**

To ensure the complete and proper design of an irrigation system, follow this eight-step procedure. The steps in this procedure must be taken in this order to reduce the chances of overlooking important factors in the process. The steps are:

1. Obtaining site information
2. Determining the irrigation requirement
3. Determining water and power supply
4. Selecting sprinklers and other equipment
5. Lateral layout (or “circuiting” sprinklers), locating valves and main lines
6. Sizing pipe and valves and calculating total system pressure loss
7. Locating controllers and sizing wire
8. Preparing the final irrigation plan

Obtaining site information is a very important step in the design procedure. Complete and accurate field information is essential for designing an efficient underground sprinkler system. Without an accurate site plan of the field conditions, there is little hope for an accurate irrigation plan.

One important note: before beginning any site plan development, be sure to check with the local utility companies for the location of any buried lines on the site. A little pre-planning can prevent costly problems in the field! It is best to minimize the crossing of utilities with the irrigation system piping and, further, to avoid locating any equipment on top of utilities.

A site plan is a scaled drawing of the areas that are impacted by the irrigation system. Before going through the effort of creating a site plan yourself, check to see if a plan already exists. If the site being designed falls within a city boundary, there may be a site plan or survey on record at the city or county planning/zoning department. Even if the plan does not have all the details necessary, it could provide a solid base to start the site plan. Newer homes may even have a computer-generated drawing available, since many housing contractors now use CAD for home and lot design. Almost all large sites have some sort of existing site plans, especially since there are so many trades involved in the site design process.

If an existing drawing cannot be obtained, a scaled drawing on graph paper is a good alternative for small sites. When this cannot be done at the site, a drawing with all the

appropriate measurements should be made so a scaled drawing can be created. A convenient scale should be selected that best fits the area onto a plan with good readable details. A residential site might fit well on a plan with a scale of 1 in = 10 ft (1 cm = 1 m). A 100 ft (30 m) wide lot would only be 10 in (30 cm) wide on the drawing. Larger areas call for smaller scales to accommodate manageable plan sizes. 1 in = 20, 30 or 40 ft (1 cm = 6, 10 or 15 m) are all common plan sizes for commercial projects. A 200-acre (81 ha) golf course might be drawn up with a scale of 1 in = 100 ft (1 cm = 30 m).

The shape of the area should be drawn on the site plan with all sides and dimensions accurately measured and represented on the drawing. Take additional measurements to assist in drawing any curves and odd angled borders. Locate all buildings, walkways, driveways, parking areas, light or utility poles, retaining walls, stairways, and any other features of the site. Indicate where there are slopes and in which direction and how steeply the ground slopes. Also make note of areas where water drift or over spray cannot be tolerated, such as windows close to the lawn areas.

Locate all trees and shrub areas and pinpoint the plant material on the drawing. Indicate any particularly dense shrubs or hedges or low trees that could hinder the sprinkler coverage. Note everything you see that could possibly impact the irrigation system, or be impacted by having water sprayed on it. Take sufficient measurements to ensure accuracy.

In addition to plotting existing planting areas, it is important to note the location of any new planting areas and the types of vegetation that these areas will contain. Indications of the soil type (sandy, clay like or a mixture) and the wind direction are also very helpful. It is particularly important to note site features that will significantly affect how the irrigation system will be designed or managed. Examples are areas of high or constant wind, daily shade, heavy clay soil, or coarse sandy soil.

The hydraulic data should always be noted. The location of the water source, such as the water meter, as well as the size of the water meter and the size, length and material of the service line should be indicated on the site plan. The static water pressure should be ascertained, preferably by a direct reading with a pressure gauge. When using a gauge, hook it up to a hose bib or garden valve. Turn the valve on to take the pressure reading when no other water outlet on the site is open.

## ***Obtaining Site Information***

If the water source for the project includes a pump, obtain the model, horsepower and electrical characteristics of the pump. The pump manufacturer will be able to provide the performance curve for the pump. Further, a pressure and flow test of the pump is advisable in case the performance has changed with wear. Should a pond or lake serve as the water source and no pumping plant currently exists, make note of the desired location and source of power for the pump. If electrical power is available, the rating (voltage and amperage) needs to be noted.

Any special considerations of the site should be noted. Some municipalities have time of day restrictions for watering. Also, the available funds or budget of the owner may determine what type of suitable irrigation system can be designed.

When the drawing from the field data is finally prepared, it should represent an accurate picture of the site and all the conditions concerning the project. This knowledge is necessary to begin an efficient irrigation plan specifically tailored to the property.

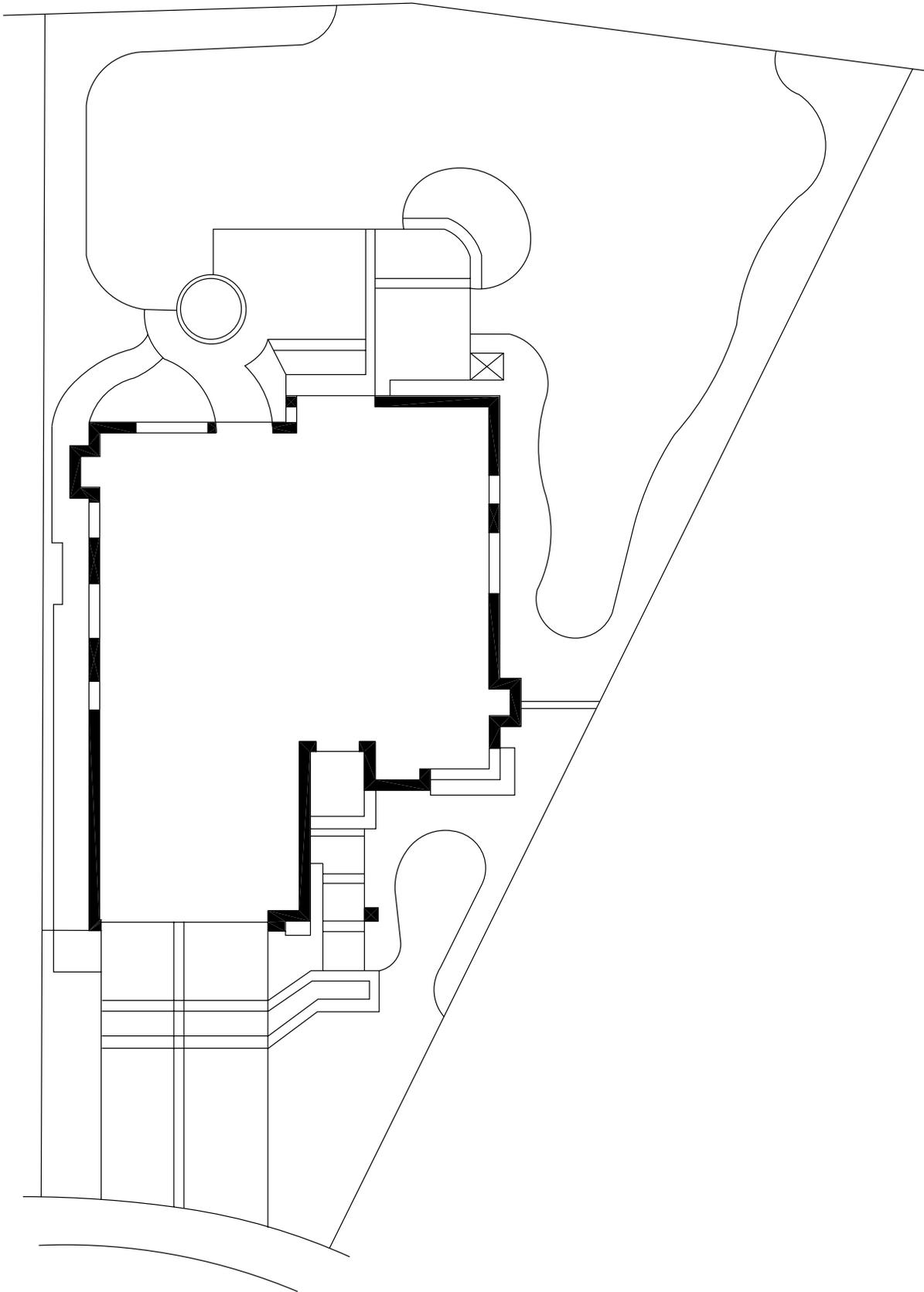

Figure 9: Basic plan drawing

**Obtaining Site Information**

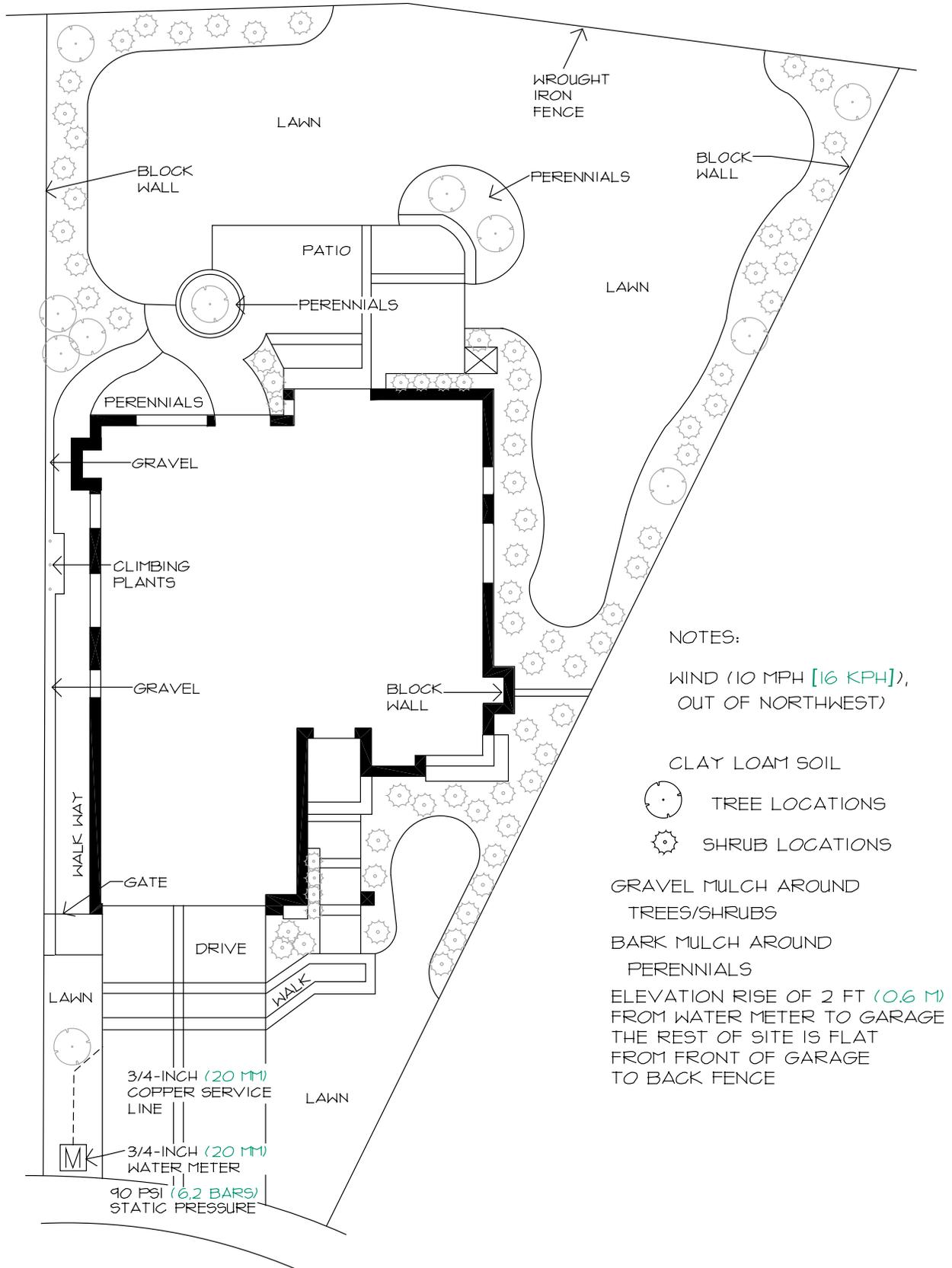
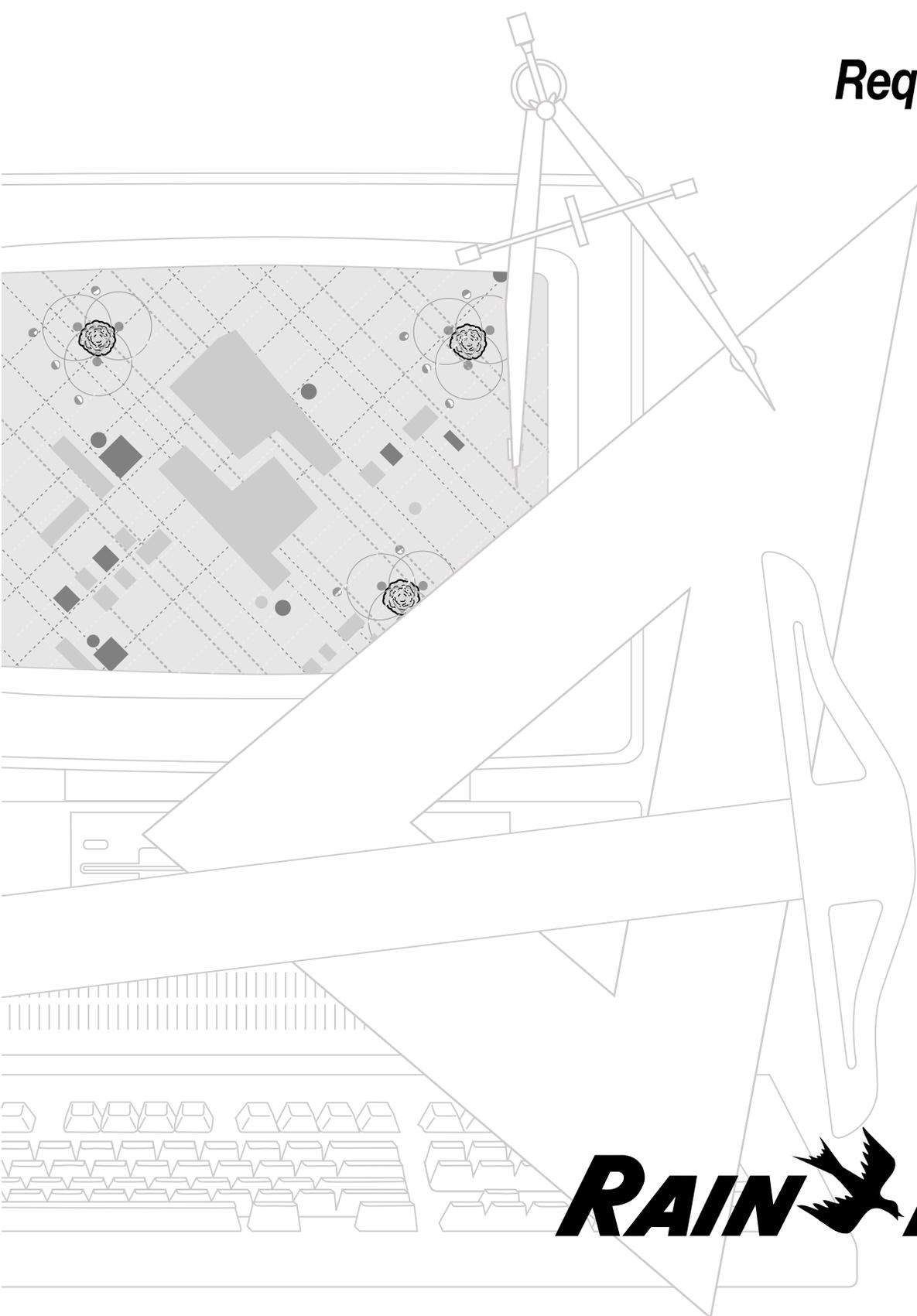

Figure 10: More detailed plan drawing

# Determining Irrigation Requirements

3



**RAIN  BIRD®**



**Step three: Determining irrigation requirements**

To answer the questions “How much water has to be applied to the plant material?” and “How often and how long does the system need to run?,” a number of factors need to be examined.

The local climate is one of the main factors that influences how much water is needed to maintain good plant growth. The plant water requirement includes the water lost by evaporation into the atmosphere from the soil and soil surface, and by transpiration, which is the amount of water used by the plant. The combination of these is **evapotranspiration (ET)**.

**ET<sub>o</sub>** stands for **reference evapotranspiration**, which is the maximum average rate of water use for plants in a given climate. Reference evapotranspiration is multiplied by a crop coefficient to obtain the ET rate for a specific plant or turf. Although it is a rough guide to water requirements and not geared to a specific plant, the table below and in the Technical Data section of this manual will help establish a ballpark figure for your project. At the design stage, the designer wants to provide an irrigation system that can meet peak season (summer time) ET rates.

In the table, note the factors that affect the water use rate for a given climate type. The three categories of “Cool,” “Warm” and “Hot” indicate that temperature has an influence on water use. The hotter the climate, the more water loss is expected. Other major factors are humidity and wind speed. If the air is humid, evaporation will be lower as compared to a climate with the same average temperature but drier air.

**Climate PET**

Climate	Inches (millimeters) Daily
Cool Humid	.10 to .15 in (3 to 4 mm)
Cool Dry	.15 to .20 in (4 to 5 mm)
Warm Humid	.15 to .20 in (4 to 5 mm)
Warm Dry	.20 to .25 in (5 to 6 mm)
Hot Humid	.25 to .30 in (6 to 8 mm)
Hot Dry	.30 to .45 in (8 to 11 mm) “worst case”

- Cool = under 70° F (21° C) as an average midsummer high
- Warm = between 70° and 90° F (21° and 32° C) as midsummer highs
- Hot = over 90° F (32° C)
- Humid = over 50% as average midsummer relative humidity [dry = under 50%]

In the table, a “Cool Humid” climate has an ET range in inches (millimeters) of water required per day of .10 to .15 in (3 to 4 mm). At the upper end of the scale, a “Hot Dry” climate produces a requirement of .30 to .45 in (8 to 11

mm) per day. These figures are rough estimates for these types of climates for an average midsummer day.

To help determine in which climate your project is located, consult the notes on “Hot,” “Warm,” or “Cool” that are listed below the PET table. Also listed are the humidity ranges that establish the “Humid” and “Dry” classifications. An irrigation system should always be designed to adequately water the project in the “worst case” condition. This is usually midsummer when the average daily temperature is at or near its highest for the growing season or when humidity is averaging its lowest percentages. Of course, a combination of these extremes produces the greatest water requirement. When you have determined the climate type for the area where your project is located, use the highest number, the “worst case” condition listed at the top of the ET range for that climate type, as the requirement for your project.

We will be discussing the precipitation rate of sprinklers later in the design process. Choosing sprinklers to match the irrigation requirement is a critical consideration for the designer. Later in this manual, we will also consider matching the scheduling of automatic irrigation controls to both the sprinkler precipitation rate and the system irrigation requirement.

The soil type on the project site is a factor in determining how fast and how often water can be applied to the plant material.

**Soil type**

Soil absorbs and holds water in much the same way as a sponge. A given texture and volume of soil will hold a given amount of moisture. The intake rate of the soil will influence the precipitation rate and type of sprinkler that can be utilized. The ability of soil to hold moisture, and the amount of moisture it can hold, will greatly affect the irrigation operational schedule.

Soil is made up of sand, silt and clay particles. The percentage of each of these three particles is what determines the actual soil texture. Because the percentage of any one of these three particles can differ, there is virtually an unlimited number of soil types possible.

The simplest way to determine the soil type is to place a moistened soil sample in your hand and squeeze. Take the sample from a representative part of the site, and from approximately the same depth to which you will be watering. In other words, if you want to water to a depth of 6 in (15 cm), dig down 6 in (15 cm) to take your soil sample.

## Determining Irrigation Requirements

Figure 11 lists the general characteristics of the three main soil types.

One of the most significant differences between different soil types is the way in which they absorb and hold water. Capillary action is the primary force in spreading water horizontally through the soil. Both gravity and capillary action influence vertical movement of water.

In coarser soils, water is more likely to be absorbed vertically, but will not spread very far horizontally. The opposite is true for finer soils.

**Note:** Emitters should not be used in very coarse soils as water will percolate downward before it can spread far enough horizontally. Micro-sprays or conventional sprinkler irrigation may be more appropriate.

Figure 12 shows the availability of water for use by plants. The moisture held in soil can be classified in three ways:

- **Hygroscopic water** is moisture that is held too tightly in the soil to be used by plants.
- **Capillary water** is moisture that is held in the pore spaces of the soil and can be used by plants.
- **Gravitational water** drains rapidly from the soil and is not readily available to be used by plants.

The **permanent wilting point** represents the boundary between capillary water and hygroscopic water. Because hygroscopic water is not usable by plants, continuous soil

moisture levels below the Permanent Wilting Point will result in the death of the plants.

**Field capacity** represents the boundary between gravitational water and capillary water. It is the upper limit for soil moisture that is usable by plants.

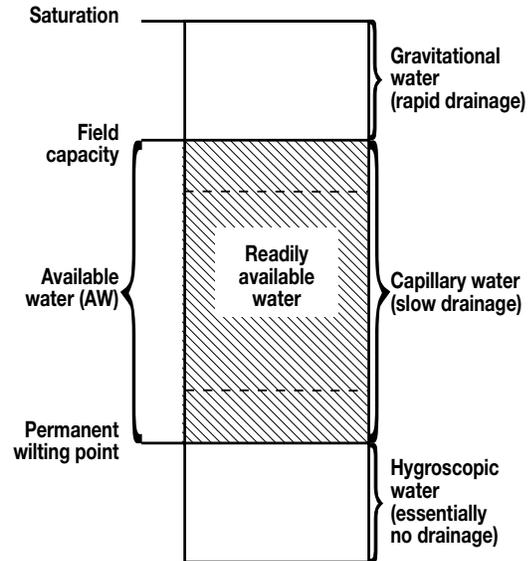

Figure 12: Soil/water/plant relationship

Figure 13 shows the way water is absorbed in the three different soil types:

- **Maximum wetting patterns** show the relationship between vertical and horizontal movement of water in

SOIL TYPE	SOIL TEXTURE	SOIL COMPONENTS	INTAKE RATE	WATER RETENTION	DRAINAGE EROSION
Sandy soil	Coarse texture	Sand	Very high	Very low	Low erosion Good drainage
		Loamy sand	High	Low	
Loamy soil	Moderately coarse	Sandy loam	Moderately high	Moderately low	Low erosion Good drainage
		Fine loam	Moderately high	Moderately low	
	Medium texture	Very fine loam	Medium	Moderately high	Moderate drainage
		Loam	Medium	Moderately high	Moderate drainage
		Silty loam	Medium	Moderately high	Moderate drainage
	Moderately fine	Silt	Medium	Moderately high	Moderate drainage
Clay loam		Moderately low	High		
Clay soil	Fine texture	Sandy clay loam	Moderately low	High	
		Silty clay loam	Moderately low	High	
		Silty clay	Moderately low	High	
		Clay	Low	High	Drainage Severe erosion

Figure 11: Soil characteristics

the soil up to the maximum wetted diameter. Once the maximum wetted diameter is reached, water movement is downward, forming the traditional “carrot,” “onion,” and “radish” profiles.

- **Maximum wetted diameter** is the greatest distance water will spread horizontally from an emitter.
- **Available water (AW)** is the amount of water that is readily available for use by plants.

Soil Type	Wetting Pattern	Maximum Wetted Diameter	Available Water (AW)
Coarse (sandy loam)		1.0 – 3.0 ft 0,3 – 0,9 m	1.4 in/ft 12 mm/m
Medium (loam)		2.0 – 4.0 ft 0,6 – 1,2 m	2.0 in/ft 17 mm/m
Fine (clay loam)		3.0 – 6.0 ft 0,9 – 1,8 m	2.5 in/ft 21 mm/m

Figure 13: Soil infiltration and wetting pattern for drip irrigation

In the Technical Data section of this manual and on page 20, is a chart labeled “Soil characteristics.” Different soil types are outlined on this chart along with properties that influence the irrigation design.

Look particularly at the information in the last three columns. The soil’s intake rate, or how fast it absorbs water, dictates how quickly water can be applied by the irrigation system. Coarse, sandy soil absorbs water very quickly while silts and clays have a very low intake rate. The fine textured soils, once wet, retain moisture longer than do the coarse-grained soils. The main problem we wish to avoid is

applying water faster than the soil can receive it. This causes runoff, erosion or soil puddling, all of which waste water and can cause damage.

Rolling terrain further complicates the problem of matching the application rate from the sprinklers with the intake rate of the soil. As the angle of slope increases, the intake rate decreases because of the higher potential for runoff.

SOIL TYPE	CHARACTERISTICS
Coarse	Soil particles are loose. Squeezed in the hand when dry, it falls apart when pressure is released. Squeezed when moist, it will form a cast, but will crumble easily when touched.
Medium	Has a moderate amount of fine grains of sand and very little clay. When dry, it can be readily broken. Squeezed when wet, it will form a cast that can be easily handled.
Fine	When dry, may form hard lumps or clods. When wet, the soil is quite plastic and flexible. When squeezed between the thumb and forefinger, the soil will form a ribbon that will not crack.

Figure 14: Determining the soil type

The “Maximum Precipitation Rates for Slopes” chart (Figure 15) lists the United States Department of Agriculture’s recommendations for the maximum PR values for certain soil types with respect to soil plant cover and percent of slope.

In the upper left section of the rate columns, the rate for coarse, sandy soil that presents a flat surface is 2.00 or 2

SOIL TEXTURE	MAXIMUM PRECIPITATION RATES: INCHES PER HOUR (MILLIMETERS PER HOUR)							
	0 to 5% slope		5 to 8% slope		8 to 12% slope		12%+ slope	
	cover	bare	cover	bare	cover	bare	cover	bare
Course sandy soils	2.00 (51)	2.00 (51)	2.00 (51)	1.50 (38)	1.50 (38)	1.00 (25)	1.00 (25)	0.50 (13)
Course sandy soils over compact subsoils	1.75 (44)	1.50 (38)	1.25 (32)	1.00 (25)	1.00 (25)	0.75 (19)	0.75 (19)	0.40 (10)
Light sandy loams uniform	1.75 (44)	1.00 (25)	1.25 (32)	0.80 (20)	1.00 (25)	0.60 (15)	0.75 (19)	0.40 (10)
Light sandy loams over compact subsoils	1.25 (32)	0.75 (19)	1.00 (25)	0.50 (13)	0.75 (19)	0.40 (10)	0.50 (13)	0.30 (8)
Uniform silt loams	1.00 (25)	0.50 (13)	0.80 (20)	0.40 (10)	0.60 (15)	0.30 (8)	0.40 (10)	0.20 (5)
Silt loams over compact subsoil	0.60 (15)	0.30 (8)	0.50 (13)	0.25 (6)	0.40 (10)	0.15 (4)	0.30 (8)	0.10 (3)
Heavy clay or clay loam	0.20 (5)	0.15 (4)	0.15 (4)	0.10 (3)	0.12 (3)	0.08 (2)	0.10 (3)	0.06 (2)

Figure 15: Maximum precipitation rates for slopes

## Determining Irrigation Requirements

in/h (51 mm/h). In the other extreme, heavy clay soil with a surface slope of 12% will accept water only at or below 0.06 in (2 mm). This means that irrigation equipment could easily cause run off or erosion if not specified and spaced correctly.

The “Slope Reference” chart (Figure 16) explains the relationship of angle, percent and ratio of slopes.

Depending on how the information has been given to the designer, he may need to convert the data to the slope reference with which he is most comfortable or familiar for drawing purposes.

Keeping the above factors in mind, the designer determines, either in inches per week or inches per day (centimeters per week or millimeters per day), the irrigation requirement for the project. When this estimate is established, he is ready to go on to the next step in the design procedure, which is determining the water and power supply available to the site.

Before going on to this next step, however, try the exercises on the next page concerning irrigation requirements and obtaining site information. The answers to the exercises are in the Solutions section on page 87.

**SLOPE REFERENCE CHART**  
PERCENT, ANGLE AND RATIO

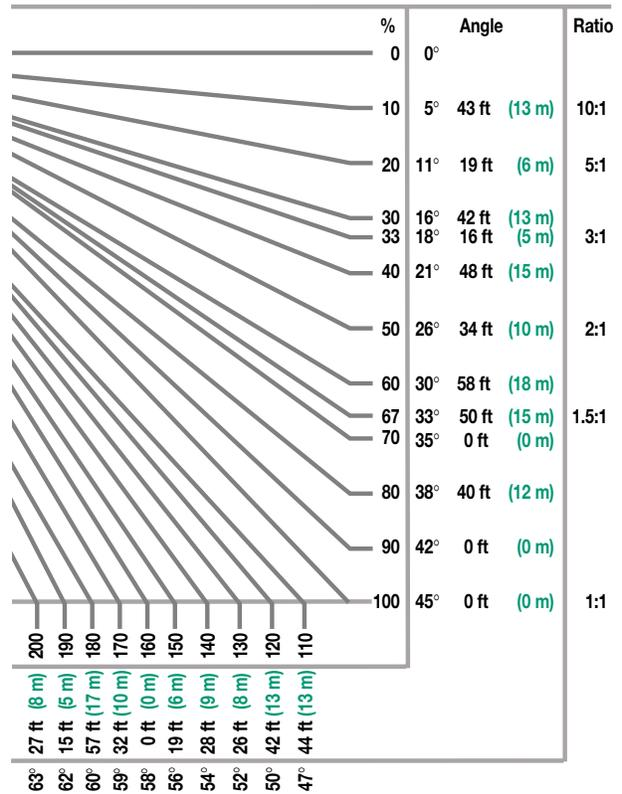

Figure 16: Slope reference

**Exercises on site information and irrigation requirements**

- A.** A \_\_\_\_\_ is a scaled drawing of the site to be used in designing a system.
- B.** The \_\_\_\_\_ water pressure should be recorded with the other information obtained on the site.
- C.** Put an X after the following items that should be noted or sketched at the site before attempting to design the system.
  - Wind direction and velocity \_\_\_\_\_
  - Tree locations \_\_\_\_\_
  - Walkways and driveways \_\_\_\_\_
  - All buildings \_\_\_\_\_
  - Location of water source \_\_\_\_\_
  - Area measurements \_\_\_\_\_
  - Walls and fences \_\_\_\_\_
  - Slopes \_\_\_\_\_
- D.** A school playing field or a neighborhood park would most likely only be irrigated at \_\_\_\_\_.
- E.** ET stands for \_\_\_\_\_.
- F.**  $ET_o$  stands for \_\_\_\_\_.
- G.** Two factors that affect the ET are \_\_\_\_\_ and \_\_\_\_\_.
- H.** A climate that has a midsummer average daily high temperature of 80° F (27° C) and an average relative humidity for the same period of 67% would be classified as a \_\_\_\_\_ climate.
- I.** What is the “worst case” in inches (millimeters) per day for a cool, dry climate?
- J.** Which of the soils listed below has a slower water intake rate and a longer water retention time than the other? Put an X after this soil type.
  - Sandy soil \_\_\_\_\_
  - Clay soil \_\_\_\_\_
- K.** Concerning steepness, a 100% slope has a ratio of 1:1 and an angle of \_\_\_\_\_ degrees.



**Determining  
Water and  
Power Supply**

**4**

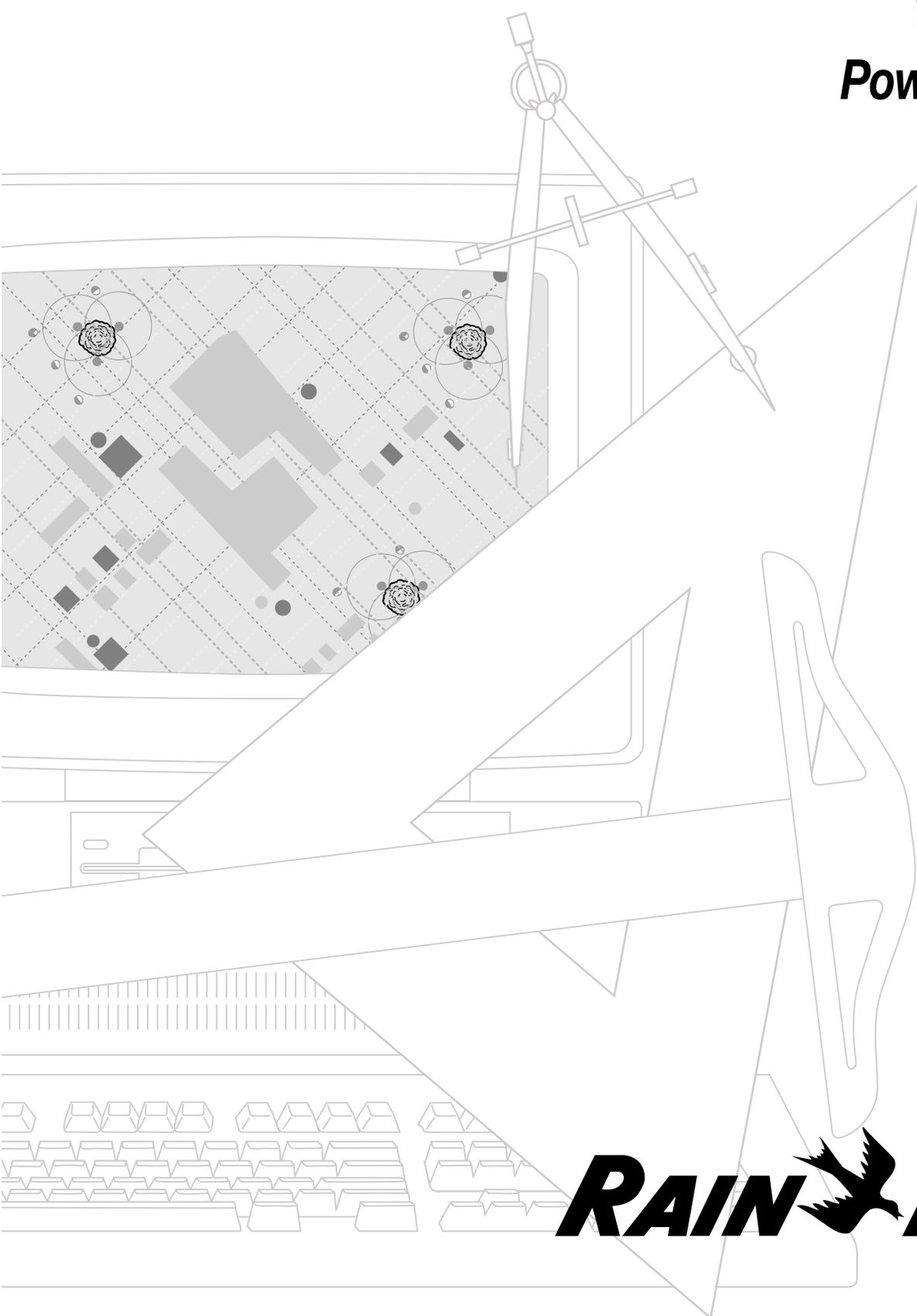

**RAIN  BIRD<sup>®</sup>**



## Step four: Determining water and power supply

In the first section of this step, the designer needs to establish two points of critical information concerning the water supply. The first number is the flow in gallons per minute (meters cubed per hour or liters per second) available for the irrigation system. The second is the working pressure in pounds per square inch (bars), at the previously determined flow, at the point-of-connection (POC) for the system.

The information gathered on site plays an important role here. The needed data includes:

- static water pressure
- water meter size
- service line size
- service line length
- type of service line pipe

The static water pressure should have been determined either by the direct pressure gauge reading, or obtained from the water purveyor. Remember that the lower pounds per square inch (bar) figure for the summer, daylight pressure (or “worst case” condition) is the number to use.

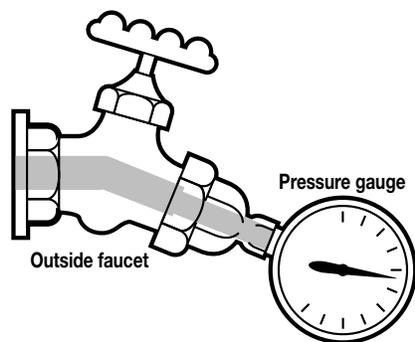

Figure 17: Faucet with pressure gauge

The size of the water meter is usually stamped or cast somewhere on the upper half of the meter itself. Sometimes, the size is printed inside the reading lid of the meter, right next to the dials. Typical water meter nominal sizes include 5/8 in , 3/4 in, 1 in, 1-1/2 in and 2 in (18 mm, 20 mm, 25 mm, 40 mm and 50 mm).

If you are unable to find the water meter size, contact your water purveyor. As you will see in a moment, the size of the meter can be a determining factor in the flow available for the system.

The service line statistics are necessary to figure out which pipe flow loss chart to use in this step. The line may be a

completely different size than the meter. The length of this line will be used with the appropriate pipe chart when determining the working pressure at the point-of-connection.

Length of string	2 3/4 in (70 mm)	3 1/4 in (83 mm)	3 1/2 in (89 mm)	4 in (10,2 cm)	4 3/8 in (11,1 cm)	5 in (12,7 cm)
Size of service line copper	3/4 in (20 mm)		1 in (25 mm)		1 1/4 in (32 mm)	
Size of service line galvanized		3/4 in (20 mm)		1 in (25 mm)		1 1/4 in (32 mm)

Figure 18: Estimated service line sizes

If you can't find the service line size, the “Estimated Service Line Sizes” chart above and in the Technical Data section of this manual will show you how to wrap a string around the pipe and measure the string to determine the pipe size. Now let's see how all this information is used.

## Calculating water meter capacity and working pressure

To find out the flow, in gallons per minute (meters cubed per hour or liters per second), available for irrigation, we use three rules. Each of these rules will give us a result expressed as gallons per minute (meters cubed per hour or liters per second). When we have established these three values, we will take the most restrictive value, the lowest flow, as our available flow for the system.

### Rule number one

**The pressure loss through the water meter should not exceed 10% of the minimum static water pressure available in the city main.**

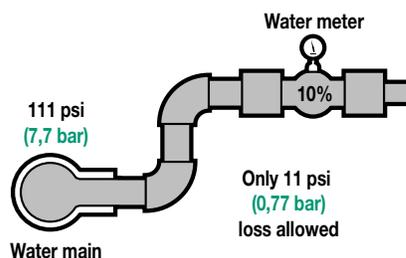

Figure 19: Pressure loss from water main to water meter

This rule prevents heavy pressure loss from occurring early in your system. To make sure this pressure loss limit is not exceeded, we restrict the flow through the meter. To ascertain this flow limit, look at a water meter flow loss chart.

This chart is set up much like a pipe flow loss chart. The gallons per minute (meters cubed per hour or liters per second) flows are listed in the right and left hand columns, the meter sizes are listed across the top of the chart and the

## Determining Water and Power Supply

flow losses in pounds per square inch (bars) are listed under each size of water meter.

As an example of using this chart in applying rule number one, consider the residential water supply system we analyzed previously. We know that the site has a 3/4 in (20 mm) water meter and the main line static pressure is 111 psi (7,7 bar). If we can only accept a loss of 10% of this 111 psi (7,7 bar), then we need to know the flow in gallons per minute (meters cubed per hour or liters per second) that will produce a loss of about 11 psi (0,77 bar).

Read down the column under the 3/4 in (20 mm) size in the water meter flow loss chart until you find the closest pound per square inch (bar) loss at, or just below, 11 psi (0,77 bar). In this example, 9.5 psi (0,77 bar) is the closest pound per square inch (bar) loss that does not exceed 11 psi (0,77 bar). According to the chart, 24 gpm (5,90 m<sup>3</sup>/h or 1,64 L/s) is the flow to satisfy rule number one.

### Pressure loss through water meters

#### AWWA standard pressure loss

##### Pressure loss: psi

Nominal Size

flow							
gpm	½ in	¾ in	1 in	1½ in	2 in	3 in	4 in
1	0.2	0.1					
2	0.3	0.2					
3	0.4	0.3					
4	0.6	0.5	0.1				
5	0.9	0.6	0.2				
6	1.3	0.7	0.3				
7	1.8	0.8	0.4				
8	2.3	1.0	0.5				
9	3.0	1.3	0.6				
10	3.7	1.6	0.7				
11	4.4	1.9	0.8				
12	5.1	2.2	0.9				
13	6.1	2.6	1.0				
14	7.2	3.1	1.1				
15	8.3	3.6	1.2				
16	9.4	4.1	1.4	0.4			
17	10.7	4.6	1.6	0.5			
18	12.0	5.2	1.8	0.6			
19	13.4	5.8	2.0	0.7			
20	15.0	6.5	2.2	0.8			
22		7.9	2.8	1.0			
24		9.5	3.4	1.2			
26		11.2	4.0	1.4			
28		13.0	4.6	1.6			
30		15.0	5.3	1.8			
32			6.0	2.1	0.8		
34			6.9	2.4	0.9		
36			7.8	2.7	1.0		
38			8.7	3.0	1.2		
40			9.6	3.3	1.3		
42			10.6	3.6	1.4		
44			11.7	3.9	1.5		
46			12.8	4.2	1.6		
...			...	...	...		

Figure 20: Pressure loss through water meters (partial)  
Please see page 119 for a metric version of the chart above.

### Rule number two

**The maximum flow through the meter for irrigation should not exceed 75% of the maximum safe flow of the meter.**

This rule is designed to protect the water meter from excess demand. If a system is designed with a flow that over-taxes the water meter, the unit will eventually fall out of calibration and ultimately fail.

Looking back to the water meter flow loss chart for the column under the 3/4 in (20 mm) size, read down to the last pound per square inch (bar) loss number listed. This loss corresponds to the gallons per minute (meters cubed per hour or liters per second) flow in the left hand column that is the maximum safe flow for the 3/4 in (20 mm) water meter. Fifteen psi (1,0 bar) is the last loss listed and reading across the column, we see that this is caused by a flow of 30 gpm (6,80 m<sup>3</sup>/h or 1,89 L/s).

Applying the second rule, we calculate 75% of this 30 gpm (6,80 m<sup>3</sup>/h or 1,89 L/s) safe flow so we are limited to 30 gpm x .75 = 22.5 gpm (6,80 m<sup>3</sup>/h x .75 = 5,10 m<sup>3</sup>/h or 1,89 L/s x .75 = 1,42 L/s).

### Rule number three

**The velocity of flow through the service line should not exceed 5 to 7-1/2 ft/s (1,5 to 2,3 m/s).**

This is similar to the 5 f/s (1,5 m/s) rule we covered in Chapter 1. Holding the velocity at 5 ft/s (1,5 m/s) is suitable for thermoplastic pipe, but this criteria is overly restrictive and impractical with the metallic pipe commonly used in the water purveyor's delivery system.

Because the 3/4 in (20 mm) water meter in our example has a 3/4 in (20 mm) copper service line, we can look up the required flow limit in the flow loss chart for copper pipe. Under the 3/4 in (20 mm) size, find the highest flow that creates a velocity at, or immediately below, 5 ft/s (1,5 m/s).

In the velocity column under that size, we can read down to the highest velocity that does not enter the shaded area on the chart. For 3/4 in (20 mm) copper water tube, the limit of 4.41 ft/s (1,34 m/s) corresponds to a flow limit of 6 gpm (1,36 m<sup>3</sup>/h or 0,38 L/s). This is so restrictive that we will use 7.5 ft/s (2,29 m/s) as the limit and see what flow that velocity allows.

According to the chart, 7.35 ft/s (2,24 m/s) is produced at a flow of 10 gpm (2,27 m<sup>3</sup>/h or 0,63 L/s) for 3/4 in (20 mm) copper tube. This places our velocity in the shaded area on the chart and still only gains us 4 gpm (0,91 m<sup>3</sup>/h or 0,25 L/s). This is typical of the types of problems a designer may run into on a project. We will see in a moment how the designer contends with this small service line situation.

## TYPE K COPPER WATER TUBE

PSI loss per 100 feet of tube (psi/100 ft)

### TYPE K COPPER WATER TUBE C=140

Sizes 1/2 in thru 3 in. Flow 1 through 600 gpm.

SIZE	1/2 in	3/8 in	1/2 in	3/4 in	1 in	1 1/4 in	1 1/2 in
OD	0.625	0.750	0.875	1.125	1.375	1.625	1.875
ID	0.527	0.652	0.745	0.995	1.245	1.495	1.745
Wall Thk	0.049	0.049	0.065	0.065	0.065	0.065	0.070

flow gpm	velocity fps	psi loss	velocity fps	psi loss	velocity fps	psi loss	velocity fps	psi loss	velocity fps	psi loss	velocity fps	psi loss
1	1.46	1.09	0.95	0.39	0.73	0.20	0.41	0.05	0.26	0.02	0.02	0.18
2	2.93	3.94	1.91	1.40	1.47	0.73	0.82	0.18	0.52	0.06	0.06	0.37
3	4.40	8.35	2.87	2.97	2.20	1.55	1.23	0.38	0.78	0.13	0.13	0.55
4	5.87	14.23	3.83	5.05	2.94	2.64	1.64	0.65	1.05	0.22	0.22	0.74
5	7.34	21.51	4.79	7.64	3.67	3.99	2.06	0.98	1.31	0.33	0.33	0.93
6	8.81	30.15	5.75	10.70	4.41	5.60	2.47	1.37	1.57	0.46	0.46	1.11
7	10.28	40.11	6.71	14.24	5.14	7.44	2.88	1.82	1.84	0.61	0.61	1.30
8	11.75	51.37	7.67	18.24	5.88	9.53	3.29	2.33	2.10	0.78	0.78	1.48
9	13.22	63.89	8.63	22.68	6.61	11.86	3.70	2.90	2.36	0.97	0.97	1.67
10	14.69	77.66	9.59	27.57	7.35	14.41	4.12	3.53	2.63	1.18	1.18	1.86
11	16.15	92.65	10.55	32.89	8.08	17.19	4.53	4.21	2.89	1.41	1.41	2.04
12	17.62	108.85	11.51	38.64	8.82	20.20	4.94	4.94	3.15	1.66	1.66	2.23
14			13.43	51.41	10.29	26.87	5.76	6.57	3.68	2.21	2.21	2.60
16			15.35	66.83	11.76	34.41	6.59	8.42	4.21	2.83	2.83	2.97
18			17.27	81.88	13.23	42.80	7.41	10.47	4.73	3.52	3.52	3.34
20			19.19	99.53	14.70	52.02	8.24	12.73	5.26	4.28	4.28	3.72
22			16.17	62.06	9.06	15.18	5.79	5.10	4.09			
24			17.64	72.92	9.89	17.84	6.31	5.98	4.46			
26			19.11	84.57	10.71	10.69	6.84	6.95	4.83			
28					11.53	23.73	7.37	7.98	5.20			
30					12.36	26.97	7.89	9.06	5.58			
35					14.42	35.88	9.21	12.06	6.51			
40					16.48	45.95	10.52	15.44	7.44			
45					18.54	57.15	11.84	19.20	8.37			
50							13.16	23.34	9.30			
55							14.47	27.85	10.23			
60							15.79	32.71	11.16			
65							17.10	37.94	12.09			
70							18.42	43.52	13.02			
75							19.74	49.46	13.95			
80									14.88			
85									15.81			
90									16.74			

Figure 21: Type K copper pipe friction loss characteristics (partial)  
Please see page 115 for a metric version of the chart above.

Our three rules-of-thumb have given us three limits:

- #1: The 10% static pressure loss through water meter rule...  
24 gpm (5,44 m<sup>3</sup>/h or 1,51 L/s) limit
- #2: 75% of meter's safe flow rule...  
22.5 gpm (5,10 m<sup>3</sup>/h or 1,42 L/s) limit
- #3: 5 to 7.5 ft/s (1,5 to 2,3 m/s) velocity rule for service line...  
10 gpm limit (2,27 m<sup>3</sup>/h or 0,63 L/s)

Of these three rules for calculating the flow for the irrigation system, we will choose the flow that is the most restrictive to establish our system capacity. In the above examples, the most restrictive is the service line rule where the flow capacity for the system is 10 gpm (2,27 m<sup>3</sup>/h or 0,63 L/s).

With the available flow understood, the working pressure for the system can now be determined.

To calculate working pressure, we take the 10 gpm (2,27 m<sup>3</sup>/h or 0,63 L/s) flow through all the components of the water service system right up to where we will cut into the service line to start the sprinkler system. The place where the designer determines to start the irrigation main line is called the point-of-connection (POC). From the source to

the POC, we will calculate the friction (or flow) loss through all those components, take into account any elevation losses or gains and calculate the remaining working pressure.

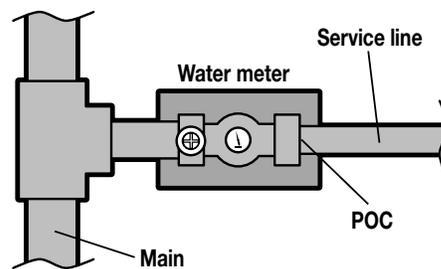

Figure 22: Water main, water meter, POC and service line

Following these calculations, we will have the dynamic pressure in pounds per square inch (bar) at a flow of 10 gpm (2,27 m<sup>3</sup>/h or 0,63 L/s). These are the two critical numbers needed to start designing the irrigation system. At the end of this section, you will have the opportunity to follow this process through while filling in the blanks for the hydraulic calculations using the sample system we have been discussing. But first, we must turn our attention to another part of this section.

In completing this step in the process of determining the project's water and power supply, the next items to check are:

- The location of the 120 V AC (230 V AC) power for the automatic irrigation controller.
- The stability of the power available. This is usually not a problem unless the property is in an outlying area, or uses its own generating equipment.
- Any restrictions on the use of the power at particular times of the day and any changes in the cost of power relative to those times.

These factors may determine where the automatic controls for the system will be located, what time of day they will be operated and how tightly they will need to be scheduled. Make sure the power location and rating are noted on the plan.

Now that we've gone over the processes for determining the water and power supply, turn the page and complete the exercises. The answers are in the Solutions section, on page 89.

## Determining Water and Power Supply

### Exercises on water capacity and pressure

A. Three rules work to establish the most restrictive flow as the available flow. Describe the rules.

---



---



---



---



---



---



---



---

Using the diagram below of our sample residential water supply system, fill in the blanks in the process for determining working pressure at maximum flow capacity.

B. Our pressure in the city main under the street is \_\_\_\_\_ psi (bar).

C. To determine the psi (bar) loss in component #1 in the diagram, look up the loss for 100 ft (100 m) of 1-1/4 in (32 mm) type K copper tube when the maximum system gallons per minute (meters cubed per hour or liters per second) is flowing through it. The gallons per minute (meters cubed per hour or liters per second) is between two listed flows on the chart.

Rounding up to the nearest whole psi (rounding up to one decimal place in bar), for 100 ft (100 m) of this tubing, the loss is \_\_\_\_\_ psi (bar). Multiply this loss by .06 to get the psi (bar) loss for only 6 ft (6 m) which is \_\_\_\_\_.

D. The loss at this same flow for component #2, a 1-1/4 in (32 mm), 90° elbow, can be determined using the “Pressure loss through copper and bronze fittings” figure in the Technical Data section of this manual. In the left column of the chart you can see the 1-1/4 in (32 mm) tube size and that the 90° elbow column is immediately to its right.

This chart tells you that a 1-1/4 in (32 mm) 90° elbow has the same flow loss as \_\_\_\_\_ feet (meters) of straight 1-1/4 in (32 mm) tubing.

We have estimated the loss for 6 ft (6 m) of tubing in “C,” dividing this number by 3, the loss for a 2 ft (2 m) length of 1-1/4 in (32 mm) tube at the maximum acceptable flow would be \_\_\_\_\_ psi (bar). That is the loss for component #2, the elbow fitting.

E. Component #3 in this system is a 3 ft (3 m) length of 1-1/4 in (32 mm) copper tube. We know the loss for a 6 ft (6 m) length from “C.” The loss for a 3 ft (3 m) length is \_\_\_\_\_ psi (bar) at the maximum system flow.

F. There is an elevation rise of 3 ft (3 m) between components #2 and #4. To find out the change in pressure we multiply 3 by \_\_\_\_\_ (in metric units, divide 3 m by \_\_\_\_\_) and get a psi (bar) change of \_\_\_\_\_. Is this a loss or a gain in pressure? \_\_\_\_\_

G. Component #4 is another 1-1/4 in (32 mm) 90° copper elbow and has the same psi (bar) friction loss as component #2, which is \_\_\_\_\_ psi (bar).

Component #5 has the same friction loss as component #3, which is \_\_\_\_\_ psi (bar).

H. Component #6 is a 1-1/4 in bronze gate valve for which there is a chart included here.

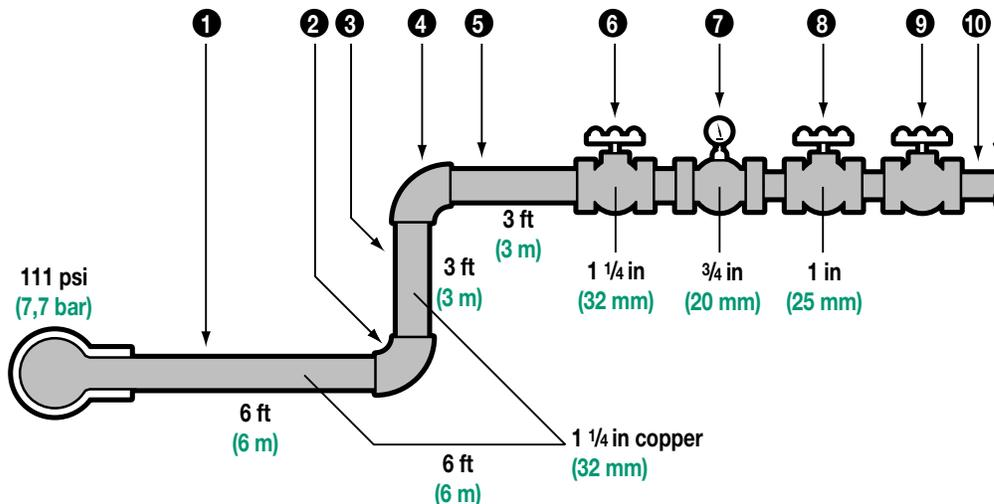

In the left column of the chart find the gallons per minute (meters cubed per hour or liters per second) that most closely approximates the maximum allowable system flow and read across to the pound per square inch (bar) loss for a 1-1/4 in valve. This loss is \_\_\_\_\_ psi (bar).

- I. The loss for a 3/4 in (20 mm) water meter, component #7, is \_\_\_\_\_ psi (bar) at the system's maximum flow.
- J. What is the loss at this flow for component #8, a 1 in bronze gate valve? \_\_\_\_\_ psi (bar).
- K. At the #9 position, the designer requires that the installer cut into the service line and "tee off" to start his sprinkler system submain. Position #9 is called the \_\_\_\_\_.
- L. Fill in the following to find the working pressure at position #9 at the maximum flow allowable for the system.

Static pressure in the main is + \_\_\_\_\_ psi/bar.  
 Loss through component #1 is - \_\_\_\_\_ psi/bar.  
 Loss through component #2 is - \_\_\_\_\_ psi/bar.  
 Loss through component #3 is - \_\_\_\_\_ psi/bar.  
 Elevation loss is - \_\_\_\_\_ psi/bar.  
 Loss through component #4 is - \_\_\_\_\_ psi/bar.  
 Loss through component #5 is - \_\_\_\_\_ psi/bar.  
 Loss through component #6 is - \_\_\_\_\_ psi/bar.  
 Loss through component #7 is - \_\_\_\_\_ psi/bar.  
 Loss through component #8 is - \_\_\_\_\_ psi/bar.  
 The remaining pressure at #9 is \_\_\_\_\_ psi/bar.

You now know the dynamic or working pressure at point #9 when flowing the maximum acceptable gallons per minute (meters cubed per hour or liters per second) for the system.

Bronze Gate Valves (loss in psi)									
GPM	Valve Size (in inches)								
	1/2	3/4	1	1 1/4	1 1/2	2	2 1/2	3	4
1									
2	.01								
5	.06	.02							
8	.16	.05	.02						
10	.24	.08	.03	.01					
15		.17	.06	.02	.01				
20		.31	.11	.03	.02				
30			.24	.07	.04	.01			
40			.43	.13	.07	.02	.01		
50			.67	.21	.11	.04	.02		
60				.30	.15	.05	.03	.01	
80				.54	.28	.10	.05	.02	
100					.43	.15	.07	.03	
120					.62	.22	.10	.04	.02
140					.85	.30	.14	.06	
160						.40	.18	.07	.03
180						.50	.23	.09	
200						.62	.29	.11	.04
220							.42	.14	.05
240								.17	.06
260								.19	.07
280								.23	.09
300								.26	.10
350									.14
400									.18
450									.23
500									.28
550									.34
600									.40

Figure 23a: Bronze gate valves friction loss characteristics (U.S. Standard Units)

Bronze Gate Valves (loss in bar)										
l/s	m <sup>3</sup> /h	Valve Size (in inches)								
		1/2	3/4	1	1 1/4	1 1/2	2	2 1/2	3	4
0,069	0,227									
0,138	0,454	0,001								
0,345	1,134	0,004	0,001							
0,552	1,814	0,011	0,003	0,001						
0,690	2,268	0,017	0,006	0,002	0,001					
1,034	3,402		0,012	0,004	0,001	0,001				
1,379	4,536		0,021	0,008	0,002	0,001				
2,069	6,804			0,017	0,005	0,003	0,001			
2,758	9,072			0,030	0,009	0,005	0,001	0,007		
3,448	11,340			0,046	0,014	0,008	0,003	0,014		
4,137	13,608				0,021	0,010	0,003	0,021	0,001	
5,516	18,144				0,037	0,019	0,007	0,034	0,001	
6,895	22,680					0,030	0,010	0,048	0,002	
8,274	27,216					0,043	0,015	0,069	0,003	0,001
9,653	31,752					0,059	0,021	0,097	0,004	
11,032	36,288						0,028	0,124	0,005	0,002
12,411	40,824						0,034	0,159	0,006	
13,790	45,360						0,043	0,200	0,008	0,003
15,169	49,896							0,290	0,010	0,003
16,548	54,432								0,012	0,004
17,927	58,968								0,013	0,005
19,306	63,504								0,016	0,006
20,685	68,040								0,018	0,007
24,133	79,380									0,010
27,580	90,720									0,012
31,028	102,060									0,016
34,475	113,400									0,019
37,923	124,740									0,022
41,370	136,080									0,028

Figure 23b: Bronze gate valves friction loss characteristics (International System Units)



# Selecting Sprinklers and Spacing Ranges

5

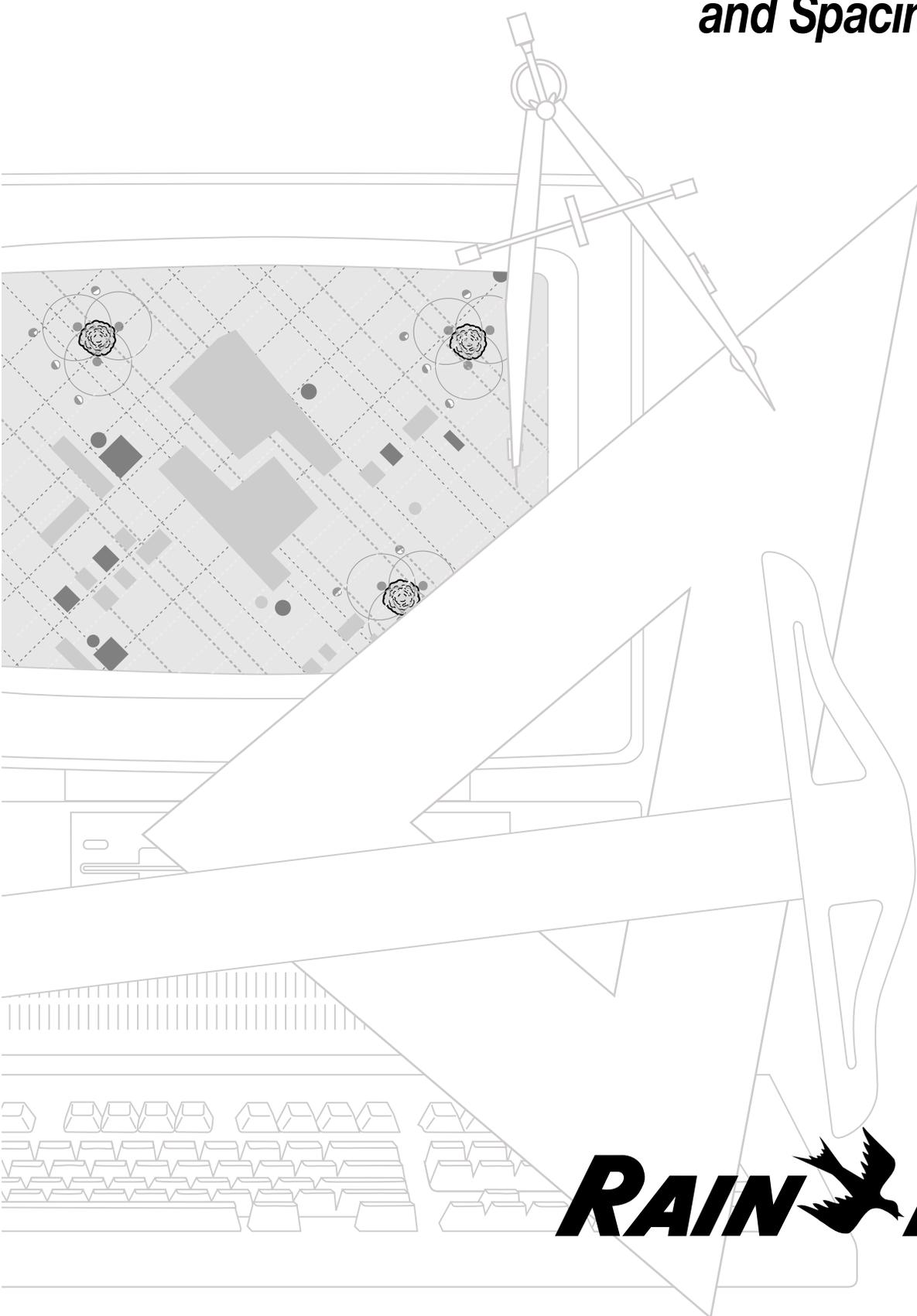

**RAIN  BIRD®**



## Step five: Selecting sprinklers and spacing ranges

Selecting sprinklers, without first researching the information supplied by the earlier steps in the design process, is premature. It is alarming to note that many would-be designers make step five the first step of their design. Most of the criteria for sprinkler selection is based on information gathered or calculated in those early steps.

### Selecting sprinklers

There are a number of types of sprinklers and irrigation devices. Each sprinkler type has a particular range of applications for which the designer would specify them. The main types of equipment are:

#### Spray sprinklers

- shrub spray sprinklers
- pop-up spray sprinklers

#### Rotating sprinklers

- impulse or impact sprinklers
- pop-up gear drive sprinklers

#### Bubblers and drip irrigation devices

- zero radius or short radius types
- ultra-low volume types

When selecting the proper sprinklers for a project, a number of factors should be considered. Some of these factors are:

- type of sprinklers requested by the owner
- size and shape of the areas to be watered
- types of plant material to be irrigated
- water pressure and flow available
- local environmental conditions such as wind, temperature, and precipitation
- soil type and the rate at which it can accept water
- compatibility of the sprinklers (which can be grouped together)

The size and shape of the areas to be irrigated often determine what type of sprinkler will be used. The goal is to select the type of sprinklers that will cover the area properly using the least number of sprinklers. The type of plant material to be irrigated can also dictate which type of sprinkler is to be used. Lawns, shrubs, trees and ground covers may all require different types of sprinklers.

As we have seen in the Understanding Basic Hydraulics section, the available water pressure and flow limit is the

designer's criteria for equipment selection. Each type of sprinkler has a performance range for proper operation and these ranges must fit within the available flow and pressure criteria, both of which are a function of the water supply.

Areas with special climatic conditions will require special sprinklers. Windy areas may demand low-angle sprinklers that keep the water near the ground where it resists being blown away. Excessive summer heat in arid climates may need either higher flow sprinklers or multiple irrigation cycles with standard sprinklers to maintain the plant material.

As we discussed in the Obtaining Site Information section, the sprinkler's application rate cannot exceed the soil's ability to accept water. Low precipitation rate sprinklers may be required to adjust the rate of water application to the intake rate of the soil. Also, low PR sprinklers are usually needed on slopes to reduce the potential for runoff and erosion.

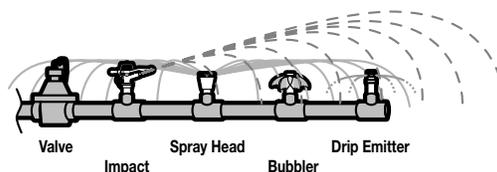

Figure 24: Avoid mixing sprinkler heads on each valve

Sprinkler compatibility is particularly important when laying out laterals or circuiting sprinklers into groups that will be served by the same valve. One of the most important rules in circuiting sprinklers is to **avoid mixing different types of sprinklers together on the same valve whenever possible**. We will be discussing precipitation rates of sprinklers in detail later in this section, however, sprinklers with differing rates of application should be separated into different valve circuits. When sprinklers with varying precipitation rates are connected together, the owner or maintenance personnel are required to over-water one area to sufficiently water another. In our sample residential design we asked the designer to violate this “don’t-mix-the-sprinklers” rule once or twice and to design his way out of the problem. You will see later just how he did it.

Even the same type of sprinklers may require separate valving to match up water application with the rest of the sprinklers. Today, matched precipitation-rate sprinklers are available. These units discharge proportional flows of water that match the arc or part of a circle they cover. A full circle sprinkler discharges twice the flow of a half circle sprinkler and a quarter circle sprinkler discharges half of what the half circle unit does. Matched precipitation allows the same

## Selecting Sprinklers and Spacing Ranges

type of sprinklers, no matter what arc they cover, to be circuited on the same valve and deliver the same PR rate.

Let's look at some of the applications for various types of sprinklers and irrigation sprinklers and examine where they would be best used on a landscaping project.

**Spray sprinklers** are required for smaller landscaped areas, for those areas with enclosed borders requiring tightly controlled spray, for areas with dense tree growth that would significantly hinder a rotating sprinkler's coverage and for areas that have mixed sections of plantings that require differing amounts of water.

Spray sprinklers generally emit single or double sheets or fans of water in a fixed pattern. These patterns are usually a particular part of a circle or arc.

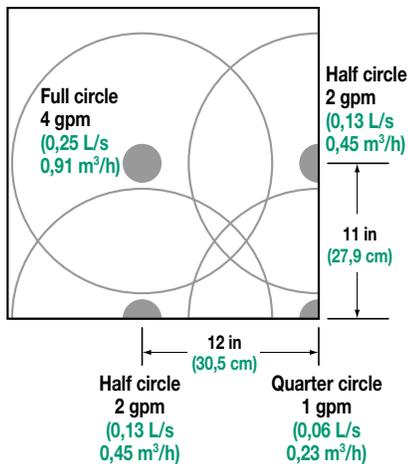

Figure 25: Matched precipitation rate sprinklers

The most common patterns are full circle, three-quarter circle, two-thirds circle, half circle, one-third circle and quarter circle. In addition to the arcs, some specialty spray patterns like center strips, side strips and end strips are available. Also available is the "variable arc nozzle" or "VAN," a hybrid spray nozzle intended to handle the occasional odd-shaped, in-between area. This type of nozzle allows the designer and installer to adjust the arc of coverage from 0 to 360°.

Stream sprays are another type of spray sprinkler that use fixed arcs of coverage. But instead of emitting a sheet or fan, they distribute water in numerous, individual fingers.

Because spray sprinklers have an operating range of approximately 15 to 30 psi (1,0 to 2,1 bar) and throw water across a radius of 5 to 22 ft (1,5 to 6,7 m), they are most often used for irrigating small areas, or for projects that have lower available water pressures.

Fan spray sprinklers distribute water fairly quickly, with application capability of 1 to 4 in/h (25 to 102 mm/h). The designer must keep this in mind on tight, fine-grained soils, or sloping ground that may not accept water quickly. Stream sprays have a more acceptable range for these applications, with precipitation rates from about 1/3 to 1-1/2 in/h (8 to 38 mm/h).



Figure 26: Spray sprinklers

Shrub spray sprinklers and pop-up spray sprinklers often use the same nozzles, but they are mounted on their respective body types. With the availability of 6 and 12 in (15,2 and 30,5 cm) pop ups, some shrub areas near walkways, stairways and sidewalks utilize these units as pop-up shrub sprinklers. The sprinklers pop down after operation, reducing the potential for vandalism and increasing pedestrian safety.

**Rotating sprinklers** are available in riser-mount configuration for irrigating larger shrub and ground cover areas, and in pop-up versions for watering turfgrasses. Rotating sprinklers use various means for converting a portion of the flow and pressure passing through them into "drive" energy to turn the sprinkler.

In general, rotating sprinklers have a single nozzle or pair of nozzles that revolve to distribute water over the area of coverage. Part circle units have a reversing or shutoff mechanism to avoid watering outside their arc pattern. Instead of fixed arcs of coverage, most part circle rotating sprinklers are adjustable from about 20 to 240°, and many

## 5 Selecting Sprinklers and Spacing Ranges

can be switched to the 360° (full circle) setting. Full circle only units are also available.

Higher operating pressures are common for rotating sprinklers compared to spray sprinklers. Available in a wide range of sizes, most rotating sprinklers on the market today operate somewhere in the 25 to 100 psi (1,7 to 6,9 bar) range. The distance of throw is much greater than for spray sprinklers. Rotating sprinklers can throw from about 20 ft (6,10 m) minimum for the small units to well over 100 ft (30,48 m) of radius for larger units. It should be noted that the flow demands for large radius sprinklers are much higher. Discharges of 5 to 100 gpm (1,13 to 22,68 m<sup>3</sup>/h or 0,32 to 6,31 L/s) or more span the wide variety of flows for rotating sprinklers.



Figure 27: Rotating sprinklers

Despite their large water flow, rotating sprinklers usually apply water much more slowly than spray sprinklers because the water is spread out over greater areas. The precipitation rates for these large sprinklers run more in the 1/4 to 2 in/h (6 to 51 mm/h) range. This makes rotating sprinklers appropriate for slopes, tight soils, and other areas where slower application rates are desired.

The most easily recognized type of rotating sprinkler is the impact sprinkler. Using a side-driving lever to create rotation, you can mount the impact sprinkler on a riser above the plant material where the stream will be unobstructed over its long radius of throw. In a large, open lawn area, rotor pop-ups can irrigate vast areas with substantially fewer sprinklers than spray sprinkler irrigation would require. Like a pop-up spray sprinkler, rotor pop-ups retract after operation to be out of the way of mowing equipment and foot traffic.

The large radius sprinklers are usually more economical, and energy and water efficient for large-area irrigation, where their streams are uninterrupted and allowed full coverage. Fewer sprinklers, fewer fittings, and less trenching are definite advantages of rotating sprinklers compared to spray sprinklers.



Figure 28: Bubbler

Bubblers and drip irrigation devices produce short throw or zero radius water distribution. The most common type of bubbler delivers anywhere from 1/2 to 3 gpm (0,11 to 0,68 m<sup>3</sup>/h or 0,03 to 0,19 L/s), depending on the pressure available and how it is adjusted. The water either runs down the riser supporting the sprinkler or sprays out a few inches (centimeters) in an umbrella pattern. The advantage of a bubbler is that it can irrigate a specific area without overthrow onto other plants. Bubblers can be used in very narrow or small planting areas, and can be adjusted to low flow so large numbers of bubblers can be mounted on one line.

Some of the latest developments in bubbler systems are the stream bubblers, which throw gentle two-to-five foot (0,6-1,5 m) radius streams, and the pressure compensating bubbler, which discharges the same flow despite wide variations in water pressure.

The primary concerns for a designer using a bubbler system are to avoid runoff and erosion by confining the water in a planter or tree basin, and to provide proper drainage in situations where an overflow would cause damage.

Drip irrigation and low-flow devices have some of the advantages of bubblers and a few more. There is less chance of runoff or erosion, and very little puddling because of the ultra-low flows of drip devices. The emitter,

## Selecting Sprinklers and Spacing Ranges

the most common drip device, is designed to take a water pressure at its inlet of about 20 psi (1,4 bar) and reduce it to almost zero. In this way, the water exits the unit one drop at a time.

The most common flow rates for emitters are 1/2 gph (2 L/h), 1 gph (4 L/h), and 2 gph (8 L/h). This is a major change from the flow rates for sprinklers. Emitters, in general, are operated much longer per irrigation cycle than sprinklers. The idea behind the application of drip irrigation is to maintain a somewhat constant, near optimum level of soil moisture in the plant's root zone. This moisture level is constantly available to the plant without saturating the soil.



Figure 29: Emitter device



Figure 30: Multi-outlet emitter device

Multi-outlet emitters, essentially several emitters in one body, use distribution tubing from each outlet on the unit to the desired emission point. Emitters are available with

barbed inlets for installation, using a punch on polyethylene tubing, or with threaded inlets for riser mounting.

Newly arrived in the low flow sector of irrigation are the tiny sprayers and spinners. These units are spaced similar to sprinklers but have very low precipitation rates. PRs of 1/3 in/h (8 mm/h) or lower are common. These little rotating spinners and fixed arc sprayers can be mounted with adapters on risers or on high pop sprinkler bodies for shrub, ground cover, or individual tree irrigation.

For further, detailed information on designing drip irrigation for landscape, see the Rain Bird Xerigation Design Manual (Catalog No. D39030C).

When looking for a particular type of sprinkler in a manufacturer's catalog, the performance chart for the sprinkler contains several pieces of important information. In the example below, you can see the type of data supplied to help you with your selection.

The **arc** or **pattern of coverage** is usually diagrammed for quick reference so the designer can see if the needed pattern is available in that particular series of sprinklers or nozzles. The model number of the sprinkler or nozzle is called out so it can be specified, by number, in the legend of the irrigation plan. The operating pressure range of the unit is also noted so that the designer will know the pressure requirements for the performance desired. This range is usually the minimum to maximum pressures under which the sprinkler will deliver good distribution of water throughout the entire area of coverage.

Another important number from a sprinkler performance chart is the **radius** or **diameter of throw**. Usually given in feet (meters), this is the actual distance determined by the manufacturer's testing at the various water pressures listed. The discharge of the nozzle or sprinkler is given for each pressure noted in the chart. For most sprinklers, the discharge is given in gallons per minute (meters cubed per hour or liters per second), and in the case of drip emitters, in gallons per hour (liters per hour). Knowing both the pressure and discharge requirements of the sprinklers is very important, as we have seen in the basic hydraulics section.

Some equipment catalogs now include the **precipitation rate of the sprinkler**. This is the water delivery rate in inches per hour (millimeters per hour) at particular sprinkler spacings. The spacings are usually stated as a **percentage of the diameter** of the sprinkler's coverage. We will get back to this concept in a moment. First, turn to the exercises on page 40 and answer the questions on selecting sprinklers. The answers are in the Solutions section on page 90.

## 15 Standard

SERIES 30° trajectory

Nozzle	Pressure psi	Radius feet	Flow gpm	Precip. ■ in/h	Precip. ▲ in/h
	15	11	2.60	2.07	2.39
	20	12	3.00	2.01	2.32
	25	14	3.30	1.62	1.87
	30	15	3.70	1.58	1.83
	15	11	1.95	2.07	2.39
	20	12	2.25	2.01	2.32
	25	14	2.48	1.62	1.87
	30	15	2.78	1.58	1.83
	15	11	1.74	2.07	2.39
	20	12	2.01	2.01	2.32
	25	14	2.21	1.62	1.87
	30	15	2.48	1.58	1.83
	15	11	1.30	2.07	2.39
	20	12	1.50	2.01	2.32
	25	14	1.65	1.62	1.87
	30	15	1.85	1.58	1.83
	15	11	0.87	2.07	2.39
	20	12	1.00	2.01	2.32
	25	14	1.10	1.62	1.87
	30	15	1.23	1.58	1.83
	15	11	0.65	2.07	2.39
	20	12	0.75	2.01	2.32
	25	14	0.83	1.62	1.87
	30	15	0.93	1.58	1.83

Figure 31a: Nozzle performance (U.S. Standard Units)

## 15 Standard

SERIES 30° trajectory

Nozzle	Pressure bar	Radius meter	Flow L/s	Flow m³/h	Precip. ■ mm/h	Precip. ▲ mm/h
	1,0	3,4	,16	,60	52	60
	1,5	3,9	,19	,72	47	55
	2,0	4,5	,23	,84	41	48
	2,1	4,6	,23	,84	40	46
	1,0	3,4	,12	,45	52	60
	1,5	3,9	,15	,54	47	55
	2,0	4,5	,17	,63	41	48
	2,1	4,6	,18	,63	40	46
	1,0	3,4	,11	,40	52	60
	1,5	3,9	,13	,48	47	55
	2,0	4,5	,15	,55	41	48
	2,1	4,6	,16	,56	40	46
	1,0	3,4	,08	,30	52	60
	1,5	3,9	,10	,36	47	55
	2,0	4,5	,11	,42	41	48
	2,1	4,6	,12	,42	40	46
	1,0	3,4	,05	,20	52	60
	1,5	3,9	,07	,24	47	55
	2,0	4,5	,08	,28	41	48
	2,1	4,6	,08	,28	40	46
	1,0	3,4	,04	,15	52	60
	1,5	3,9	,05	,18	47	55
	2,0	4,5	,06	,21	41	48
	2,1	4,6	,06	,21	40	46

Figure 31b: Nozzle performance (International System Units)

## Selecting Sprinklers and Spacing Ranges

### Exercises on selecting sprinklers

- A.** Put an **X** after each of the factors below that affect sprinkler selection.

Area size \_\_\_  
Area shape \_\_\_  
Water pressure \_\_\_  
Wind conditions \_\_\_  
Types of plants \_\_\_  
Flows available \_\_\_  
Slope on site \_\_\_

- B.** Put an **X** after the type of sprinkler you should specify for the center of the outfield on an automatic sprinkler system for a baseball field.

Pop-up spray head \_\_\_  
Rotor pop-up \_\_\_  
Shrub stream spray \_\_\_  
Drip emitter \_\_\_  
Bubblers \_\_\_

- C.** Put an **X** after the type of sprinklers listed below that would be most economical and efficient for irrigating several acres of ground cover.

Spray sprinklers on risers \_\_\_  
Bubblers on risers \_\_\_  
Impact sprinklers on risers \_\_\_  
High pop-up spray sprinklers \_\_\_

- D.** For small patches and strips of lawn area, which type of sprinklers should be used for irrigation? Put an **X** after the correct type.

Spray sprinklers on risers \_\_\_  
Bubblers on risers \_\_\_  
Rotor pop-ups \_\_\_  
Impact sprinklers on risers \_\_\_  
Pop-up spray sprinklers \_\_\_

- E.** Put an **X** after each true statement listed below.

Spray sprinklers generally have fixed arc patterns \_\_\_

Rotor pop-ups usually have adjustable arcs \_\_\_

For large-radius coverage, an impact sprinkler would be a better choice than a spray sprinkler \_\_\_

In general, spray sprinklers require more water pressure than rotating sprinklers \_\_\_

An emitter is a drip irrigation device \_\_\_

- F.** Put an **X** after the items below that can usually be found in an irrigation equipment manufacturer's catalog.

The radius of coverage for a sprinkler \_\_\_

The company's profit and loss statement \_\_\_

The model numbers for the equipment \_\_\_

The flow requirement for sprinklers \_\_\_

The pressure requirement for sprinklers \_\_\_

The arc pattern for a sprinkler \_\_\_

**Spacing sprinklers and calculating precipitation rates**

Before talking about sprinkler spacing patterns, let's take a look at sprinkler distribution in general, and the need for overlapping sprinkler coverage in particular.

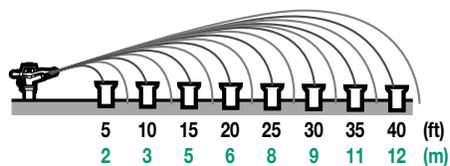

Figure 32: Measuring sprinkler distribution with containers

When a sprinkler is tested to determine its distribution rate curve (often abbreviated as DRC), the sprinkler is placed at a given point and containers are positioned at equal intervals along a leg of the expected radius of coverage. The sprinkler is operated for a predetermined amount of time and then the water in each container is measured to determine how well the sprinkler distributed the water.

DRCs can be obtained from Rain Bird or they can be obtained from an independent testing agency such as the Center for Irrigation Technology (CIT) in Fresno, California. Understanding the DRC also allows the comparison of sprinkler, pressure and nozzle combinations to determine which combination has the potential to apply water with the greatest efficiency. One metric used to compare DRCs is the **scheduling coefficient** or **SC**.

SC is calculated for overlapping sprinklers. The calculation can be done on a theoretical basis or using catch can measurements made on site by operating a built irrigation system. SC is the average depth of water in the catch cans divided by the depth of water in the catch can having the least amount of water. A perfect, and non-existent, SC is one. Actual SCs are greater than 1.0 and the potentially most efficient overlap patterns are those with the lowest SC. Practically speaking, an SC of 1.15 is considered excellent.

Rain Bird can provide graphics that help ascertain the best DRC, and consequently the best SC, or CIT has a computer program available that can be used to compare DRCs.

The resulting data, when plotted on a graph, should ideally look like a 30° slope coming down from the sprinkler location — a wedge. In the case of a full circle sprinkler, the graph would look like a cone with the sprinkler location at the center and the sloping sides indicating less and less water being measured as the distance increases from the sprinkler. Finally, where the sprinkler radius came to an

end, there would be a container far enough from the sprinkler to have no measurable water.

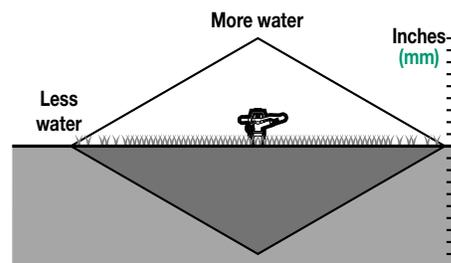

Figure 33: Sprinkler water distribution graph

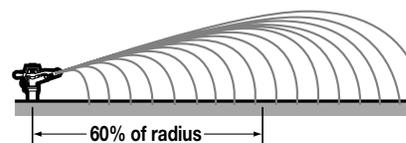

Figure 34: 60% sprinkler radius

The area under the first 60% of the sprinkler's radius is generally sufficiently irrigated to grow vegetation without the need for an overlapping sprinkler. Beyond this 60% line, the amounts of water, diminishing with distance, become less and less effective and eventually will not support plants.

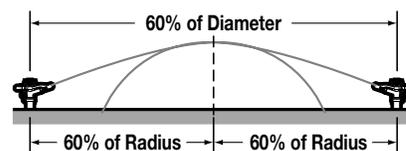

Figure 35: 60% diameter sprinkler spacing

The maximum spacing recommended, therefore, is where the sprinkler is located, so its 60% of radius line meets the 60% line of its neighbor. This is the 60% of diameter that was noted earlier. The less effective, last 40% of each sprinkler's throw is overlapped into the more effective close-in coverage of the adjacent sprinkler. In cases where very coarse soil, high winds, low humidity or high heat inhibit effective irrigation, closer spacing is recommended.

Head-to-head, or 50% sprinkler spacing, is the most common spacing used in landscape irrigation. Where winds are a threat to good coverage, spacing as close as 40% may be required. When sprinkler spacing is stretched, turfgrass will exhibit dry spots within the area of the spacing pattern. These weak spots may show up as lighter green turf, yellowing or brown foliage or dead plant material. When the system is installed and this problem of "stretched" spacing shows up, the project owner often overwaters the rest of the areas trying to make up for the lack of water in the weak spots.

## Selecting Sprinklers and Spacing Ranges

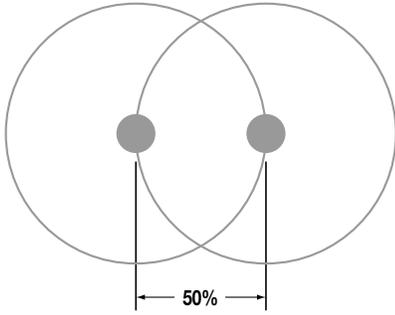

Figure 36: 50% sprinkler head spacing

One of the main reasons for carefully selecting the sprinklers is so they can be accurately plotted on the plan. Once the designer chooses the equipment he or she plans to use, proper spacing is the next critical step. The site information will usually dictate what spacing pattern makes those arcs of coverage fit into the planting areas.

There are three main types of sprinkler spacing patterns and a number of variations to adapt these patterns to special situations.

The **square pattern**, with its equal sides running between four sprinkler locations, is used for irrigating areas that are square themselves, or have borders at 90° angles to each other, and that confine the design to that pattern. Although the square pattern is the weakest for proper coverage if not used carefully, enclosed areas often rule out the use of other patterns.

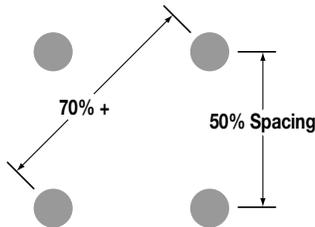

Figure 37: Square sprinkler spacing pattern

The weakness in square spacing coverage is caused by the diagonal distance between sprinklers across the pattern from each other. When the sprinklers are spaced head-to-head along the sides of the square pattern, the distance between sprinklers in opposite corners of the pattern is over 70% spacing. This 70% diagonal stretch across the square pattern can leave a weak spot at the center. The wind may move the weak spot slightly away from the center and summer heat may make the weak spot quite large if it is a common climatic condition for the site.

To minimize the effects of wind trouble when using the square pattern, closer spacings (which require more

sprinklers) are recommended, depending on the severity of the wind conditions. The recommendation on the chart for low or no wind is for 55% spacing. And on projects with higher winds, the spacing should be reduced as indicated below.

For sites with wind velocities of:	Use maximum spacings of:
0 to 3 mph (0 to 5 km/h)	55% of diameter
4 to 7 mph (6 to 11 km/h)	50% of diameter
8 to 12 mph (13 to 19 km/h)	45% of diameter

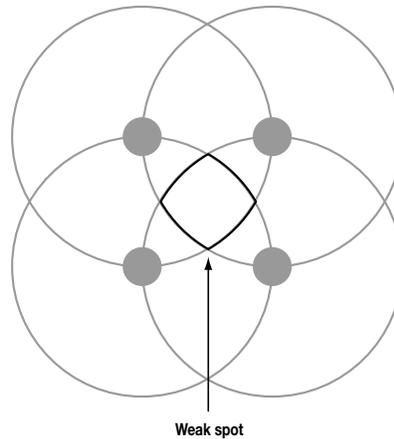

Figure 38: Square sprinkler spacing pattern weak spot

The **triangular pattern** is generally used where the area to be irrigated has irregular boundaries or borders that are open to over spray, or do not require part-circle sprinklers. The equilateral triangle pattern, where the sprinklers are spaced at equal distances from each other, has some advantages over square spacing.

Because the rows of sprinklers are offset from adjacent rows to establish the triangular pattern, the weak spot that could be a problem in square spacing is absent. In most cases, the sprinklers can be spaced further using triangular spacing than with square spacing. This additional distance between sprinklers often means fewer sprinklers will be required on the project. Fewer sprinklers on the site means less equipment cost for the project, less installation time and lower maintenance costs over the life of the system.

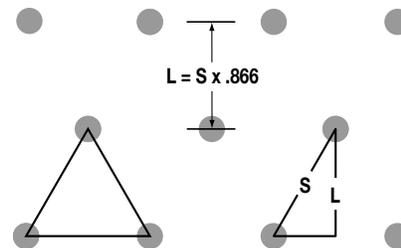

Figure 39: Triangular sprinkler spacing pattern

## 5 Selecting Sprinklers and Spacing Ranges

The dimensions of a spacing pattern are often labeled “S” and “L.” “S” stands for the **spacing** between sprinklers and “L” stands for the spacing between the rows of sprinklers or **laterals**. In an equilateral triangular spacing pattern, the distance “L” (the height of the triangle) is the sprinkler spacing “S” x .866. If large rotors on a golf course were spaced at 80 ft (25 m) in an equilateral triangular pattern, the distance between rows of sprinklers would be 80 ft (25 m) x .866 = 69.28 ft (21,65 m).

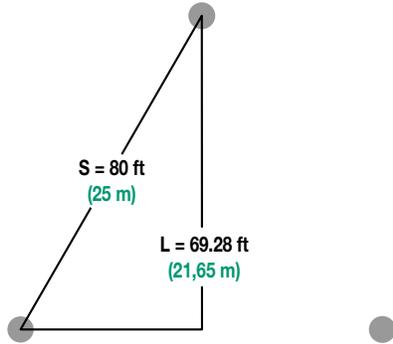

Figure 40: S and L triangular sprinkler spacing pattern

As you can see, there is no unequally stretched spacing like the diagonal line in square spacing. Because of this factor, the spacing recommendations of an equilateral triangular pattern are somewhat less restrictive for windy conditions. The chart allows greater distances between sprinklers beginning with 60% spacing and reducing down to head-to-head spacing for windier areas.

For sites with wind velocities of:	Use maximum spacings of:
0 to 3 mph (0 to 5 km/h)	60% of diameter
4 to 7 mph (6 to 11 km/h)	55% of diameter
8 to 12 mph (12 to 19 km/h)	50% of diameter

The **rectangular pattern** has the advantages of fighting windy site conditions and being able to fit in areas with defined straight boundaries and corners. By closing in the spacing across the wind and opening up the length of the pattern with the wind, the designer can maintain good sprinkler coverage.

In each case listed on the chart, the length of the pattern remains at 60% spacing, while the distance across the wind is decreased to combat increasing velocities.

For sites with wind velocities of:	Use maximum spacings of:
0 to 3 mph (0 to 5 km/h)	L = 60% of diameter S = 50% of diameter
4 to 7 mph (6 to 11 km/h)	L = 60% of diameter S = 45% of diameter
8 to 12 mph (13 to 19 km/h)	L = 60% of diameter S = 40% of diameter

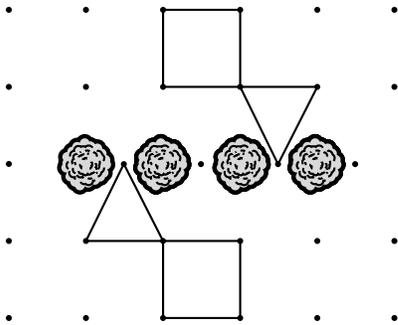

Figure 41: Staggered sprinkler spacing pattern

Combinations of the various patterns mentioned so far may be used on the same area of a project to adapt to special conditions. If the designer is laying out sprinklers for a lawn area, for instance, and comes to a tree or row of shrubs, a staggered spacing pattern to adjust for the obstacles can be used. By staggering the pattern from square or rectangular to a slightly tilted parallelogram or to triangular shape, the degree of coverage can be maintained even though the pattern doesn't match the rest of the area. After positioning the sprinklers to surround or pass through the area of the obstructions, the designer can return from the staggered pattern to the original spacing pattern.

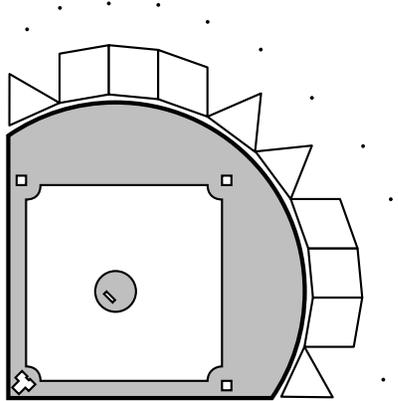

Figure 42: Sliding pattern

To adapt to a curving boundary, the **sliding pattern** allows for a gradual change from perhaps square or rectangular spacing to a parallelogram, and then to triangular spacing and back again if necessary. By sliding the pattern to maintain spacing requirements along a curving border, the designer avoids bunching up sprinklers on the inside curves and stretching the spacing on outside curves.

A good example for the use of the sliding pattern method is the sprinkler spacing often designed for the outfield of a baseball field. The designer may start with rectangular spacing behind third base and, while following the outside curve of the scalped area of the baselines, gradually slide

## Selecting Sprinklers and Spacing Ranges

through the parallelogram patterns to triangular behind second base, and continue sliding back through the patterns to rectangular again behind first base. This sliding method of spacing the sprinklers would continue right out to the part-circle sprinklers along the outfield fence.

If the designer knows how many inches (millimeters) of water per week or per day will be required to properly maintain the plant material for the project, the next thing to know is the rate at which the sprinklers will apply the water. The precipitation rate of the sprinklers selected should be calculated to determine first if the rate exceeds the soil's intake rate (which it shouldn't) and, secondly, if the rate will apply enough water during acceptable operating times to meet the irrigation requirement (which it should).

The average precipitation rate is expressed in inches per hour (millimeters per hour). A simple formula is used to calculate precipitation rates for sprinklers using the area inside the sprinkler spacing and the gallons per minute (cubic meters per hour) being applied to that area. The formula looks like this:

$$PR = \frac{96.3 \times \text{gpm (applied to the area)}}{S \times L}$$

$$\left( PR = \frac{1000 \times \text{m}^3/\text{h} \text{ [applied to the area]}}{S \times L} \right)$$

Where:

PR = the average precipitation rate in inches per hour	PR = the average precipitation rate in millimeters per hour
96.3 = a constant which incorporates inches per square foot per hour	1000 = a constant which converts meters to millimeters
gpm = the total gpm applied to the area by the sprinklers	m <sup>3</sup> /h = the total m <sup>3</sup> /h applied to the area by the sprinklers
S = the spacing between sprinklers	S = the spacing between sprinklers
L = the spacing between rows of sprinklers	L = the spacing between rows of sprinklers

The constant of 96.3 (1000) is derived as follows:

$$1 \text{ gal water} = 231 \text{ in}^3 \quad 1 \text{ ft}^2 = 144 \text{ in}^2 \\ (1000 \text{ mm} = 1 \text{ m})$$

**Question:** If one gallon of water was applied to 1 ft<sup>2</sup> how deep in inches would the water be?

$$\frac{231 \text{ in}^3/\text{gal}}{144 \text{ in}^2/\text{ft}^2} = 1.604 \text{ in deep}$$

One of the multipliers in the upper half of the equation is the gallons per minute applied by the sprinklers. To convert

this to gallons per hour we need to multiply by 60 minutes. To work this into the constant, we multiply 1.604 in x 60 min and we come up with the 96.3 for the formula. (In the International System Units version of the formula, because the multipliers already are in meters cubed per hour, you do not need to convert the 1000 before using it in the formula.)

Let's look at an example of a precipitation rate calculation for four full circle impact sprinklers. Each sprinkler has a radius of throw of 40 ft (12 m) at 40 psi (3 bar), a discharge of 4.4 gpm (1 m<sup>3</sup>/h) and the sprinklers are spaced at 40 ft (12 m) square spacing. The diagram of the sprinkler pattern would look like Figure 43.

Each full circle sprinkler delivers only 1/4 of its flow into the area between the four sprinklers. The other 3/4 of each sprinkler's rotation pattern is outside the area. With 4.4 gpm (1 m<sup>3</sup>/h) total per sprinkler, only 1.1 gpm (0,25 m<sup>3</sup>/h) is delivered per sprinkler into the area between them. When four sprinklers delivering 1.1 gpm (0,25 m<sup>3</sup>/h) each are added together, they are the equivalent of one full circle sprinkler or 4.4 gpm (1 m<sup>3</sup>/h). With full circle sprinklers, you can use the equivalent of one sprinkler's discharge as the gallons per minute (meters cubed per hour) for the precipitation rate formula.

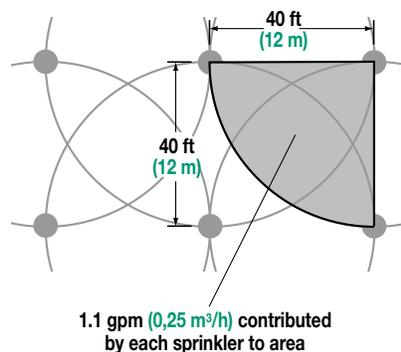

Figure 43: Square sprinkler spacing pattern with full circle sprinkler

The formula for this example would be:

$$PR = \frac{96.3 \times 4.4 \text{ gpm}}{40 \text{ ft} \times 40 \text{ ft}} = \frac{423.72}{1600} = .2648 \text{ in/h}$$

$$\left( PR = \frac{1000 \times 1 \text{ m}^3/\text{h}}{12 \text{ m} \times 12 \text{ m}} = \frac{1000}{144} = 6,94 \text{ mm/h} \right)$$

The above calculation tells the designer that the sprinklers at that spacing, if given the pressure required, will apply water at slightly more than 1/4 in (6,9 mm) per hour. Using the same 40 ft x 40 ft (12 m x 12 m) spacing that we used earlier, let's look at those same sprinklers in half circle configuration.

## 5 Selecting Sprinklers and Spacing Ranges

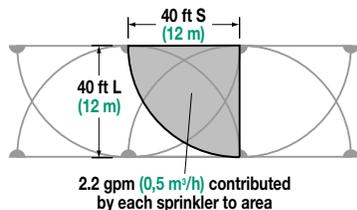

Figure 44: Square sprinkler spacing pattern with part circle sprinkler

With the same performance specs of 4.4 gpm (1 m<sup>3</sup>/h) per sprinkler and all the sprinklers now set at half circle, the formula is:

$$PR = \frac{96.3 \times 8.8 \text{ gpm}}{40 \text{ ft} \times 40 \text{ ft}} = \frac{847.44}{1600} = .529 \text{ in/h}$$

$$\left( PR = \frac{1000 \times 2 \text{ m}^3/\text{h}}{12 \text{ m} \times 12 \text{ m}} = \frac{2000}{144} = 13.89 \text{ mm/h} \right)$$

Even though there are eight sprinklers in the diagram, we are only interested in the area between four adjacent sprinklers. The 8.8 gal (2 m<sup>3</sup>/h) was determined by adding up the part of the discharge from each sprinkler that it contributed to the area. With each sprinkler in the half circle setting, one half of its flow was distributed into the square pattern while the other half went into the neighboring pattern. The amount of flow per sprinkler, then, was 2.2 gpm (0,5 m<sup>3</sup>/h) multiplied by four sprinklers for a total of 8.8 gpm (2 m<sup>3</sup>/h).

Spray sprinklers have fixed arcs of coverage and some have matched precipitation rates. Let's look at a PR calculation for four spray sprinklers in the corner of a lawn area with these statistics:

- Spacing: S = 11 ft (3 m), L = 12 ft (4 m)
- Operating pressure at the sprinklers = 25 psi (1,7 bar)
- Radius of throw = 11 ft (3 m), regardless of pattern
- Discharge: Full circle = 2.4 gpm (0,56 m<sup>3</sup>/h)
- Half circle = 1.2 gpm (0,28 m<sup>3</sup>/h)
- Quarter circle = .6 gpm (0,14 m<sup>3</sup>/h)

The spacing pattern might look like this:

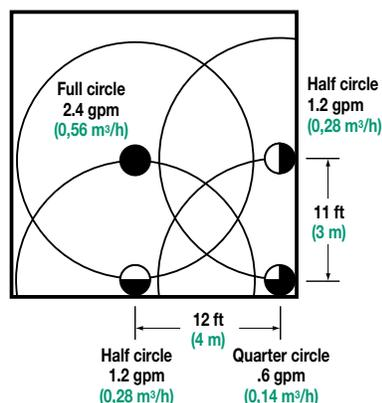

Figure 45: PR calculation for four spray heads

The total amount of water being applied to the area by these matched precipitation rate spray sprinklers is:

- Full circle sprinkler = 0.6 gpm (0,14 m<sup>3</sup>/h) [1/4 of its discharge]
- Half circle sprinkler = 0.6 gpm (0,14 m<sup>3</sup>/h) [1/2 of its discharge]
- Half circle sprinkler = 0.6 gpm (0,14 m<sup>3</sup>/h) [1/2 of its discharge]
- Quarter circle sprinkler = 0.6 gpm (0,14 m<sup>3</sup>/h) [all of its discharge]
- Total = 2.4 gpm (0,56 m<sup>3</sup>/h) applied to the area

In calculating the rate for this example, the formula would be:

$$PR = \frac{96.3 \times 2.4 \text{ gpm}}{11 \times 12} = \frac{231.12}{132} = 1.75 \text{ in/h}$$

$$\left( PR = \frac{1000 \times .56 \text{ m}^3/\text{h}}{3 \times 4} = \frac{560}{12} = 46,67 \text{ mm/h} \right)$$

Having completed the calculation, the designer knows to expect a precipitation rate of 1.75 in/h (47 mm/h).

Triangular spacing is just as easy to work with when calculating the precipitation rate as square or rectangular spacing. The main difference is calculating the height of the pattern before using it as one of the dimensions in the formula.

In this example, large size rotor pop-up sprinklers are spaced head-to-head at 70 ft (21 m) in a triangular pattern. The gallons per minute (meters cubed per second) from each of these full circle sprinklers is 27.9 (6,33 m<sup>3</sup>/h). The pattern would look like this:

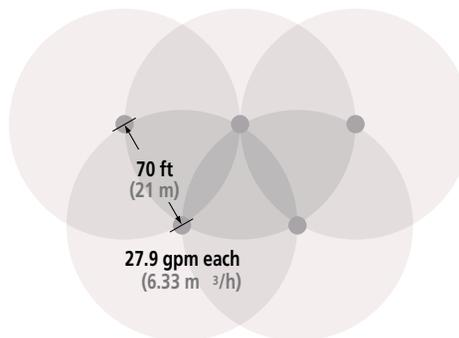

Figure 46: Calculating triangular sprinkler spacing

One dimension in the spacing pattern is 70 ft (21 m), the spacing between sprinklers, and the other is the height of the pattern, the spacing between rows of sprinklers. This height is the spacing multiplied by .866. In this case, we have a height calculation of 70 ft x .866 = 60.62 ft (21 m x .866 = 18,19 m). The dimensions to use in the PR formula for this situation are 70 ft x 60.62 ft (21 m x 18,19 m).

The easiest way to calculate the PR for triangular patterns is to treat them as parallelograms, using four sprinklers instead

## Selecting Sprinklers and Spacing Ranges

of three. When examining the pattern as a parallelogram, you can see that two of the sprinklers are contributing less of an arc (and therefore a smaller part of their flow to the area) than the other two. The other two, however, contribute proportionally larger flows so that the total flow matches that of four sprinklers in a rectangular pattern.

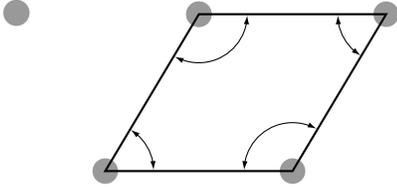

Figure 47: Calculating the PR for triangular sprinkler spacing patterns

The PR calculation for this example would be:

$$PR = \frac{96.3 \times 27.9 \text{ gpm}}{70 \text{ ft} \times 60.62 \text{ ft}} = \frac{2686.77}{4243.4} = .633 \text{ in/h}$$

$$\left( PR = \frac{1000 \times 6.33 \text{ m}^3/\text{h}}{21 \text{ m} \times 18.19 \text{ m}} = \frac{6330}{381.99} = 16.57 \text{ mm/h} \right)$$

Now that you have been exposed to calculating precipitation rates, see how you do on a few sample problems relating to what we have covered. Turn the page and complete the exercises, then compare your answers to those in the Solutions section on page 90.

## 5 Selecting Sprinklers and Spacing Ranges

### Exercises on spacing sprinklers and calculating precipitation rates

Put an **X** after the correct answers below.

- A.** What is the maximum sprinkler spacing recommended in this manual when site conditions are near optimum (very limited irrigation interference from wind, heat, soil type, etc.) for good sprinkler coverage?

If you can see one sprinkler from its neighbor, that's close enough \_\_\_\_

Head-to-head spacing only 60% of the sprinkler's diameter of throw \_\_\_\_

The outer radius of throw from one sprinkler touching the outer radius of throw of the next sprinkler \_\_\_\_

- B.** Which spacing pattern below has a wind-fighting advantage as well as being adaptable to areas with straight borders and 90° corners?

Sliding pattern \_\_\_\_

Rectangular pattern \_\_\_\_

Triangular pattern \_\_\_\_

Square pattern \_\_\_\_

Elliptical pattern \_\_\_\_

- C.** If not designed carefully, which spacing pattern has the probability of a "weak spot?"

Sliding pattern \_\_\_\_

Rectangular pattern \_\_\_\_

Triangular pattern \_\_\_\_

Square pattern \_\_\_\_

Elliptical pattern \_\_\_\_

- D.** The flow in the precipitation rate formula is:

Always the equivalent of one full circle sprinkler \_\_\_\_

Never the equivalent of one full circle sprinkler \_\_\_\_

Only the flow entering the pattern we're checking \_\_\_\_

The grains per million of grit in the water \_\_\_\_

- E.** The 96.3 (1000) in the precipitation rate formula:

Is a constant \_\_\_\_

Converts minutes to hours \_\_\_\_

Is for full circle sprinklers only \_\_\_\_

Converts feet-of-head (meters-of-head) to psi (bar) \_\_\_\_

- F.** "S" and "L" in the precipitation rate formula refer to:

Sprinkler spacing and row spacing \_\_\_\_

Distance between sprinklers on a line and between that line and the next \_\_\_\_

"S" is spacing between sprinklers, "L" is for spacing between rows of sprinklers on their laterals \_\_\_\_

- G.** Calculate the precipitation rate for the sprinklers in the diagram below.

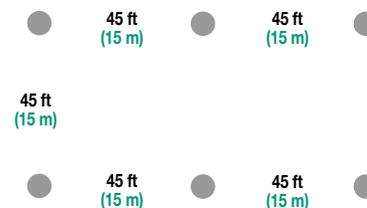

gpm (m<sup>3</sup>/h) per sprinkler = 5 (2)  
 distance of throw = 45 ft (15 m)  
 type of sprinkler = impact (rotating sprinkler)  
 sprinkler setting = full circle

Fill in the formula and the PR.

$$\frac{96.3 \times ? \text{ gpm}}{? \times ?} = \left( \frac{1000 \times ? \text{ m}^3/\text{h}}{? \times ?} \right)$$

- H.** The answer to the formula is in \_\_\_\_\_ per \_\_\_\_\_.

- I.** Answer the questions concerning the diagram below:

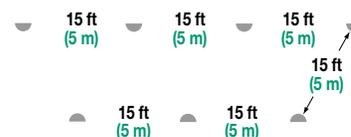

spacing pattern = equilateral triangle  
 gpm (m<sup>3</sup>/h) per sprinkler = 2 (0,45)  
 radius of sprinkler = 15 ft (5 m)  
 type of sprinkler = half circle spray sprinkler

There are seven sprinklers in the diagram. In the procedure for calculating the PR for equilateral triangular spacing, this manual suggests using \_\_\_\_\_ as the number of heads in the pattern and treating the pattern like a \_\_\_\_\_.

The height of the sprinkler pattern can be determined by multiplying 15 ft (5 m) times \_\_\_\_\_ for an answer of \_\_\_\_\_ ft (m).

Fill in the blanks of the formula for the precipitation rate of the sprinklers depicted in the above diagram.

$$\frac{96.3 \times ? \text{ gpm}}{? \times ?} = \left( \frac{1000 \times ? \text{ m}^3/\text{h}}{? \times ?} \right)$$

## Selecting Sprinklers and Spacing Ranges

### Locating sprinklers on the plan

With all that has been covered concerning sprinkler performance, sprinkler spacing and calculating precipitation rates, we are now ready to use this information to properly locate sprinklers on the plan.

Properly locating the sprinklers is extremely important! An irrigation system is one of the few items that is purchased and then buried in the ground. Major problems are difficult to correct after a system has been installed, and even minor mistakes in the design or installation phases of the project can be costly to correct.

The goal in positioning the sprinklers is to make sure all areas that require irrigation have adequate sprinkler coverage. **Remember not to stretch the spacing between sprinklers beyond their recommended ranges.** The row of sprinklers on the project that might be eliminated because all the other rows were stretched, will cost the system owner many times the money saved on initial installation. To make up for poor coverage, the owner will likely apply more water. Over the life of the system, much money will be lost in water waste.

Here are some of the things to keep in mind after you have selected the sprinkler for a particular area:

#### 1. Begin laying out sprinklers in trouble areas first.

“Trouble areas” are those with odd shapes, prominent obstructions, confined spaces or other features that require special spacing considerations. After establishing the sprinkler locations in the “trouble areas,” move out into the open areas by using sliding or staggered spacing.

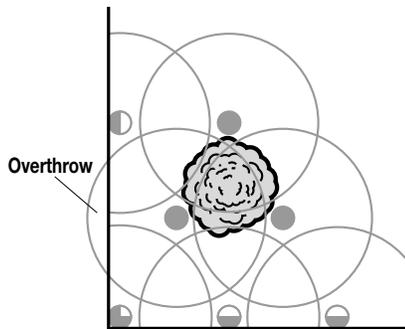

Figure 48: Sprinkler pattern for shrubs and trees

The exact locations of trees on (or to be planted on) the site are important so the designer can provide for them in sprinkler spacing. For trees or large bushes and hedges that are not to be irrigated separately, the sprinklers in the area should surround and throw into or under the plants. For the sprinklers spaced too near, this larger foliage acts as a barrier to good distribution. If the tree or large bush can be

watered along with the turf or ground cover without over watering, surround it with at least three sprinklers so it doesn't affect coverage of the other plantings.

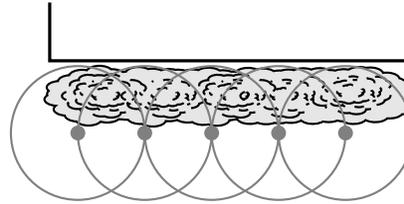

Figure 49: Sprinkler pattern for hedges

A dense hedge, if not to be watered by bubblers or drip irrigation, can often be thrown into by nearby sprinklers. If, instead, bubblers are to be used for trees or hedges, a low flow bubbler should be used (.25 gpm to .50 gpm [0,06 to 0,11 m<sup>3</sup>/h or 0,02 to 0,03 L/s]) or a standard flow bubbler (1 gpm [0,23 m<sup>3</sup>/h or 0,06 L/s] or more) using a basin to catch any runoff. For information on designing drip irrigation, see the Rain Bird Xerigation Design Manual (Catalog No. D39030C).

**2. Where possible, use the same types of sprinklers over a given area.** Remember the next step after plotting the sprinklers is to group them into valve circuits or laterals. If the turf area on your plan is covered by all spray sprinklers except for rotor pop-ups on one slightly wider spot, the rotors will have to be valved separately from those spray sprinklers. Try not to isolate three or four special sprinklers that will require their own valve if it really is not necessary.

**3. After locating all the sprinklers on the plan, visually check the entire system for proper spacing and good coverage.** This is the time to make any slight adjustments, add or delete sprinklers and check spacing before drawing in any pipe routing.

Let's look at some typical sprinkler-locating methods for handling various types of planting areas.

**Small planters and narrow planting beds** can usually be adequately irrigated with drip irrigation, flood bubblers, stream bubblers or short-radius spray sprinklers. If a planter is narrow with walled or bermed borders, flood bubblers can be used to fill the reservoir area under the plants. Slightly wider planting areas can use stream bubblers that can throw gentle streams out to a radius of 5 ft (1,5 m). Narrow lawn strips can be watered by short-radius spray sprinklers with strip pattern nozzles.

Let's see how the designer handled planters and narrow beds in the sample project (see Figure 50). From the designer's plan, we can see that low-flow drip irrigation has

been used for the planting beds. The drip irrigation pipe is shown graphically by a single dashed line winding through the planting beds. The individual emitters that provide water to the plants are typically not shown on the designer's plan. Areas "D", "E" and "H" each represent individual drip laterals. The trees in the planting beds will use multi-outlet emitters, with four outlets open. The shrubs each have two single-outlet emitters. Because drip irrigation has very low flows, typically measured in gallons per hour (liters per hour) as opposed to gallons per minute (meters cubed per hour or liters per second), drip emitters and sprinklers are never mixed on the same valve.

In the planting beds of area "I," the designer has specified tiny micro-sprays, or xeri-sprays, that have been adapted to 12 in (30,5 cm) pop-up spray sprinklers. In the one isolated part of area "H", on the edge of the walkway between the houses, the designer chose flood bubblers mounted on risers for the climbing plants.

**Landscaped strips** can be irrigated in several ways. For strips that are 4 to 7 ft (1,22 to 2,13 m) wide, pop-ups for lawns and shrub sprinklers or high-pops for shrub areas can be used with center strip or end strip spray nozzles. These nozzles have a "bow tie" or half-bow tie pattern and are located down the center of the area. For strips with trees in the center of the shrub or lawn area, the side strip nozzle can cover the area from each edge of the strip instead of the center where the trees would block the spray. Wider strips, more than 6 to 7 ft (1,83 to 2,13 m) in dimension, can use half circle spray sprinklers throwing in from both edges.

Narrow strips and confined areas often use low-angle trajectory or flat-angle spray sprinklers to reduce the chances of over spraying the area. Many strips and planter areas are bordered by walkways, such as the common areas between apartments, condominiums and offices where overspray is unacceptable.

VAN, or variable arc nozzles, are used when the standard arc configuration does not provide adequate coverage. The unusual shape of area "G" lends itself to using VAN nozzles. Half circle nozzles would create overspray into other areas, third and quarter circle nozzles would not provide enough coverage. VANs are adjustable to any arc from 0° to 360°.

In the **wider lawn areas**, the designer is using standard arc spray patterns. In area "B," the designer has selected 12 ft radius (3,66 m radius) spray nozzles and in the narrow part of the lawn in area "C," he has switched to 10 ft radius (3,05 m radius) nozzles.

Area "E," the back lawn, has very few wide areas, so the designer has decided to irrigate the entire lawn with 4 in (10,2 cm) pop-up spray sprinklers rather than use rotor pop-ups. Because it is subjected to more wind, the U-Series nozzle was selected for the back lawn. This nozzle is less susceptible to wind drift, an important consideration since the prevailing wind is toward the house.

On the irrigation plan, the designer has shown the check arcs for the sprinklers. Check arcs represent the maximum effective radius for the sprinkler. Showing the check arcs on the plan gives the designer a visual indication that all areas are effectively covered. They also point out any areas where over spray may occur. Sprinklers which exhibit over spray can be adjusted in the field using the throw adjustment capability of the head.

**Wider, more open areas** are easier to design irrigation for than smaller more broken up areas. In the past, small impact sprinklers and rotor pop-up sprinklers had a radius of about 40 ft (12,19 m) with an adjustment range down to the mid-30 ft (10,67 m) range. Spray sprinklers were used where the area to be watered was 30 ft (9,14 m) wide or less. The 30 ft (9,14 m) wide area was commonly handled by three rows of 15 ft (4,57 m) radius spray sprinklers — a row of half circle sprinklers down each edge of the area, and a row of full circle sprinklers down the center.

With the advent of the small turf area rotor pop-ups and small, light-impact sprinklers that have a range from 17 to 40 ft (5,18 to 12,19 m), the designer has a decision to make for areas in the 20 ft (6,10 m) range. Beyond 15 ft (4,57 m) or so, two rows of spray sprinklers would be stretched too far. However, simply switching to a larger radius may not be the best design answer either. A decision between using three rows of spray sprinklers, or switching to a two-row design with rotating sprinklers, may be influenced by any number of factors.

If low trees would obstruct the longer, higher throw of the rotating sprinkler, perhaps the spray sprinklers are more appropriate for watering the area. Spray sprinklers are often more appropriate for areas that have lots of curving edges. It may be difficult to avoid overthrow or gain complete coverage with a larger radius sprinkler. If low precipitation rates were required for this medium-wide area, then rotating sprinklers delivering less than .75 in (19 mm) of water per hour would be better than spray sprinklers delivering over 2 in (51 mm) of water per hour. Perhaps the higher cost per unit of rotating sprinklers would be more than offset by elimination of the middle row of spray sprinklers because the installation expense of

## Selecting Sprinklers and Spacing Ranges

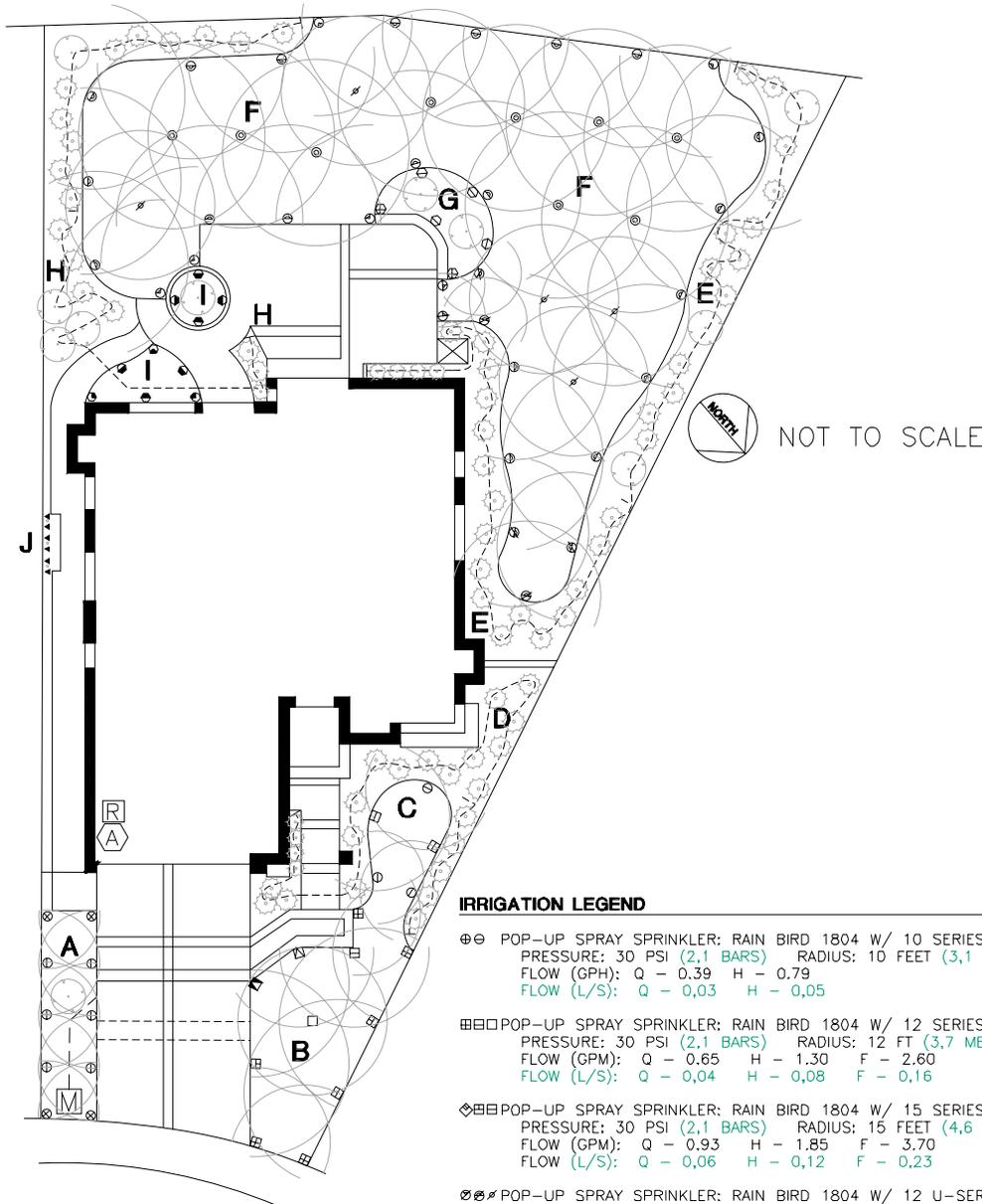

### IRRIGATION LEGEND

- ⊕ ⊕ POP-UP SPRAY SPRINKLER: RAIN BIRD 1804 W/ 10 SERIES NOZZLE  
 PRESSURE: 30 PSI (2,1 BARS) RADIUS: 10 FEET (3,1 METERS)  
 FLOW (GPH): Q - 0,39 H - 0,79  
 FLOW (L/S): Q - 0,03 H - 0,05
- ⊕ ⊕ ⊕ POP-UP SPRAY SPRINKLER: RAIN BIRD 1804 W/ 12 SERIES NOZZLE  
 PRESSURE: 30 PSI (2,1 BARS) RADIUS: 12 FT (3,7 METERS)  
 FLOW (GPM): Q - 0,65 H - 1,30 F - 2,60  
 FLOW (L/S): Q - 0,04 H - 0,08 F - 0,16
- ⊕ ⊕ ⊕ ⊕ POP-UP SPRAY SPRINKLER: RAIN BIRD 1804 W/ 15 SERIES NOZZLE  
 PRESSURE: 30 PSI (2,1 BARS) RADIUS: 15 FEET (4,6 METERS)  
 FLOW (GPM): Q - 0,93 H - 1,85 F - 3,70  
 FLOW (L/S): Q - 0,06 H - 0,12 F - 0,23
- ⊕ ⊕ ⊕ ⊕ ⊕ POP-UP SPRAY SPRINKLER: RAIN BIRD 1804 W/ 12 U-SERIES NOZZLE  
 PRESSURE: 30 PSI (2,1 BARS) RADIUS: 12 FEET (3,7 METERS)  
 FLOW (GPM): Q - 0,65 H - 1,30 F - 2,60  
 FLOW (L/S): Q - 0,04 H - 0,08 F - 0,16
- ⊕ ⊕ ⊕ ⊕ ⊕ POP-UP SPRAY SPRINKLER: RAIN BIRD 1804 W/ 15 U-SERIES NOZZLE  
 PRESSURE: 30 PSI (2,1 BARS) RADIUS: 15 FEET (4,6 METERS)  
 FLOW (GPM): Q - 0,93 H - 1,85 F - 3,70  
 FLOW (L/S): Q - 0,06 H - 0,12 F - 0,23
- ⊕ ⊕ ⊕ POP-UP SPRAY SPRINKLER: RAIN BIRD 1812 W/ 10 SERIES VAN NOZZLE  
 PRESSURE: 30 PSI (2,1 BARS) RADIUS: 10 FEET (3,1 METERS)  
 FLOW (GPM): Q - 0,50 H - 1,02 F - 1,96  
 FLOW (L/S): Q - 0,05 H - 0,09 F - 0,16
- ⊕ ⊕ XERI-SPRAY ON RAIN BIRD 1812 SPRINKLER  
 PRESSURE: 30 PSI (2,1 BARS) RADIUS: 10 FEET (3,1 METERS)  
 FLOW (GPH): XS-090 - 31,0 XS-180 - 31,0  
 FLOW (L/H): XS-090 - 117,49 XS-180 - 117,49
- ▲ PRESSURE COMPENSATING BUBBLER ASSEMBLY: RAIN BIRD 1404  
 PRESSURE: 30 PSI (2,1 BARS) FLOW: 0,5 GPM (0,03 L/S)

Figure 50: Plan, locating sprinklers

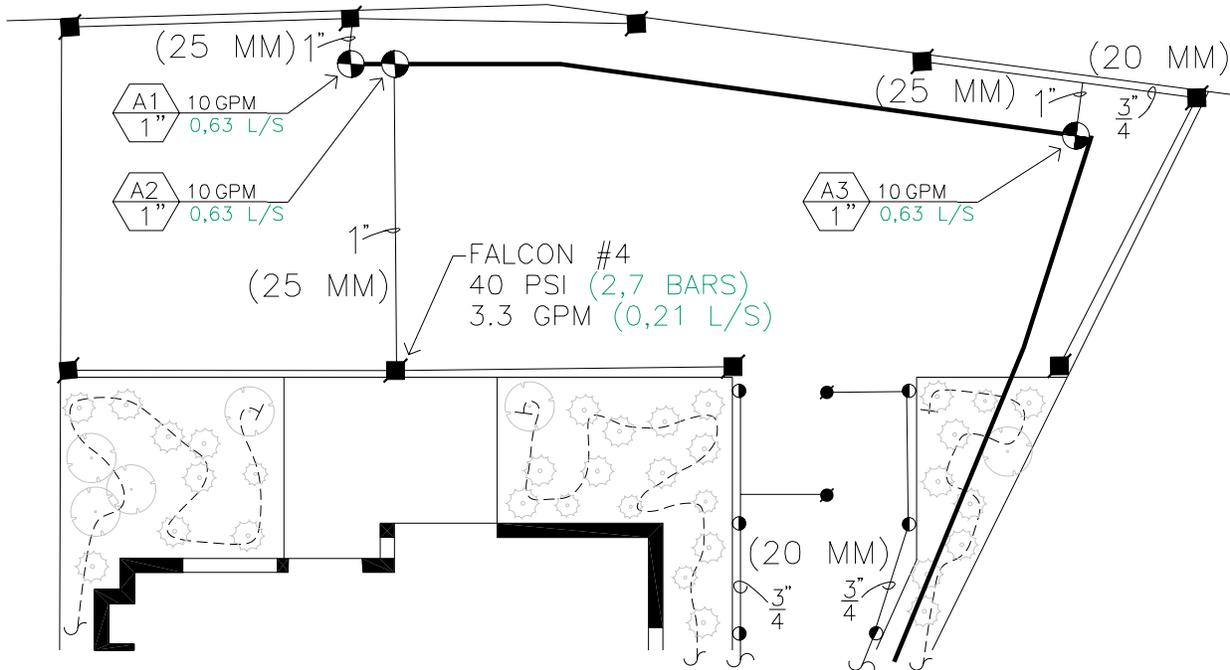

Figure 51: Plan, alternate backyard

trenching and installation would go down. The decision is up to the designer, who takes into account the special needs of the site along with practical experience.

In the "Alternate Back Yard" illustration (see Figure 51) you can see what the sprinkler locations would have been if the landscape plan for our sample project had a wider, more open, lawn area. Note how few rotor pop-up sprinklers are required for the large area and how low the lateral flows might have changed.

This particular project did not require rotor pop-ups, not just because of moderate lawn width, but also because the high-angle throw of the rotors might drift to the back windows in the constant wind.

**Very large, open areas** are the domain of the rotating sprinkler. Large lawns, sports fields, vast shrub or ground cover areas, slopes, parks, schools, golf courses and agricultural fields allow for the efficient use of large radius sprinklers. The more common rectangular, parallelogram and triangular spacing patterns can be used for maximum spacing and wind resistance.

At this point in the design process, the drawing of the irrigation plan should show every area to be irrigated and designed with properly spaced sprinklers. With this accomplished, the designer is ready to proceed with the next step, which is to group the sprinklers into valve groups. Before we proceed to that step, complete the exercises on page 52, then check your answers in the Solutions section on page 90.

## Selecting Sprinklers and Spacing Ranges

### Exercises on locating sprinklers

Put an **X** after each correct answer to the multiple choice questions.

- A.** For a shrub bed that is 14 ft (4,3 m) wide, which spray sprinkler listed below would be spaced closest to its "60% stretch rule" across the shrub bed if there was a row of the heads down each side?

A 15 ft (4,5 m) radius spray sprinkler \_\_\_\_

A 12 ft (3,6 m) radius spray sprinkler \_\_\_\_

A 10 ft (3,0 m) radius spray sprinkler \_\_\_\_

An 8 ft (2,4 m) radius spray sprinkler \_\_\_\_

A 6 ft (1,5 m) radius spray sprinkler \_\_\_\_

- B.** In the spacing illustration below, if the area were a lawn and the lawn dimensions were 12 ft x 24 ft (3,6 m x 7,2 m), what type of sprinkler should be plotted at the locations shown?

A 15 ft (4,5 m) radius shrub sprinkler \_\_\_\_

A 30 ft (9,0 m) radius impact sprinkler \_\_\_\_

A 12 ft (3,6 m) radius pop-up spray sprinkler \_\_\_\_

An 8 ft (2,4 m) radius pop-up spray sprinkler \_\_\_\_

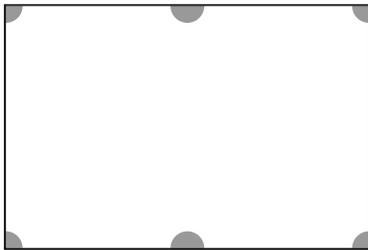

- C.** If the area in the illustration was 30 ft x 60 ft (9,0 m x 18,0 m) and the owner of the property had mistakenly installed only six 15 ft (4,5 m) radius spray sprinklers in the positions shown, plot the positions on the drawing where additional 15 ft (4,5 m) radius sprinklers would be required for head-to-head coverage.

- D.** What was the total number of sprinklers required for the illustration in question "C"?

8 sprinklers \_\_\_\_

10 sprinklers \_\_\_\_

12 sprinklers \_\_\_\_

13 sprinklers \_\_\_\_

14 sprinklers \_\_\_\_

15 sprinklers \_\_\_\_

- E.** If the original six sprinklers for the question "C" illustration were 30 ft (9,0 m) radius rotor pop-up sprinklers, how many would be required for head-to-head coverage?

6 sprinklers \_\_\_\_

8 sprinklers \_\_\_\_

10 sprinklers \_\_\_\_

12 sprinklers \_\_\_\_

- F.** Which spacing pattern would the 30 ft (9,0 m) radius rotor pop-ups in question "E" be using?

Square \_\_\_\_

Sliding \_\_\_\_

Triangular \_\_\_\_

Rectangular \_\_\_\_

- G.** If a tree or large bush in the center of a lawn area can tolerate the same amount of water as the turfgrass, it is best to plot the sprinklers to \_\_\_\_\_ the bush or tree to avoid blocking the sprinklers' coverage of the lawn.

- H.** A single tree rose with a basin dug out around its base could be watered efficiently by which two items below?

A bubbler \_\_\_\_

An impact sprinkler \_\_\_\_

A rotor pop-up \_\_\_\_

An emitter \_\_\_\_

A side strip \_\_\_\_

- I.** Without knowing any other information about the site, what type of sprinkler listed below would most likely be best for a large slope application?

Bubbler \_\_\_\_

Impact sprinkler \_\_\_\_

Side strip \_\_\_\_

Fan spray sprinkler \_\_\_\_

*Lateral Layout,  
Circuiting Sprinklers  
into Valve Groups*

6

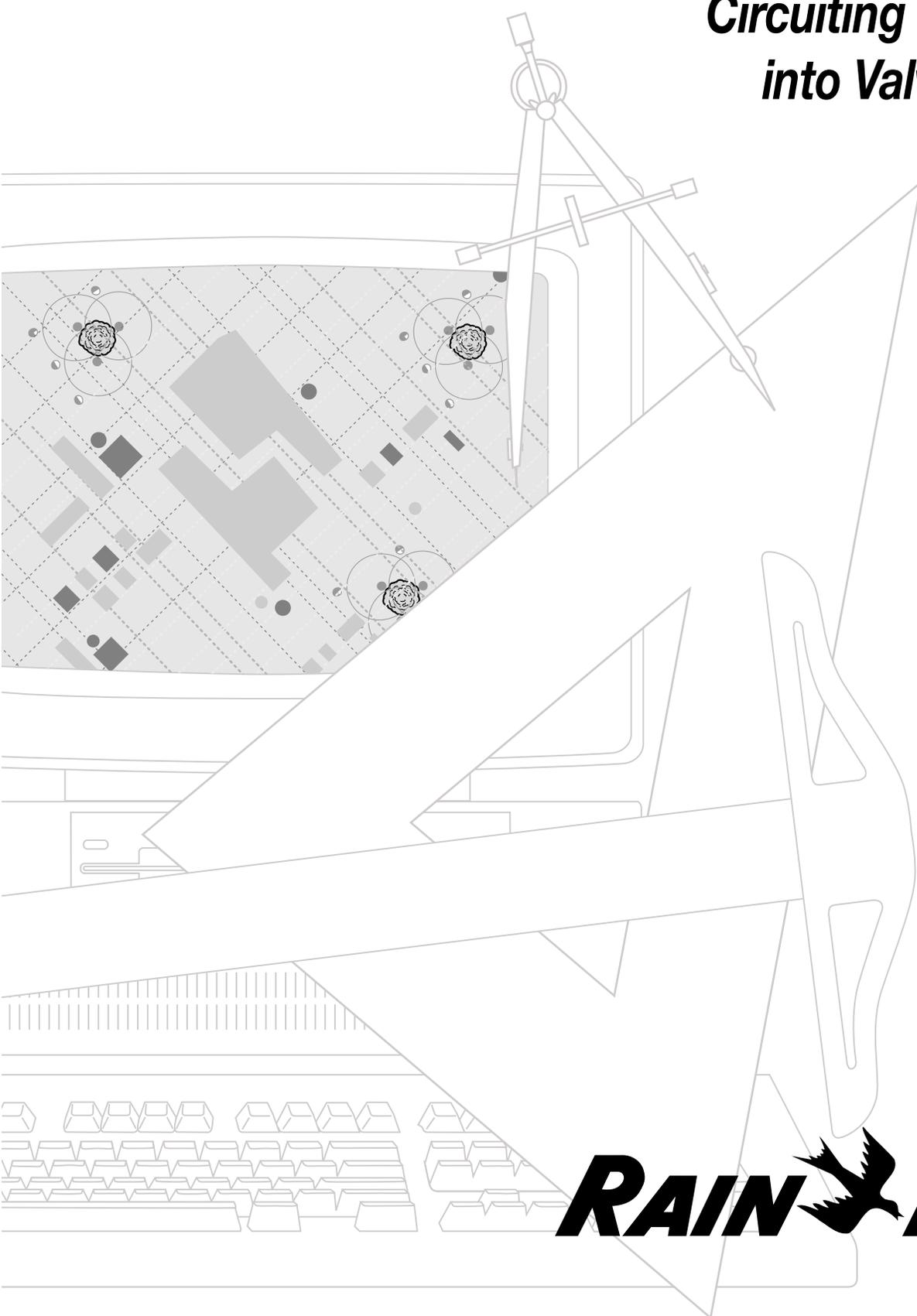

**RAIN  BIRD®**



### Step six: Lateral layout, circuiting sprinklers into valve groups

This is the designer's first opportunity to discover the number of valves that the project will require and what size controller or timer will be needed. At this step in the process, the drawing of the plan should be complete to the point where every area to be irrigated has been drawn with properly spaced sprinklers. We know that the available flow for the project was determined to be 10 gpm (2,27 m<sup>3</sup>/h or 0,63 L/s).

We start establishing laterals by first adding up the flows of similar sprinklers in each area. The spray sprinklers in area "A" are one such group. Adding up the flow for all 10 sprinklers produces a flow of 6.3 gpm (1,43 m<sup>3</sup>/h or 0,40 L/s).

In the front yard, the designer has split the front lawn into three valves, two in area "B" and one in area "C". Area "C" was placed on a separate lateral because the sprinkler spacing is different enough from area "B" to warrant a different zone. Also, area "B" receives full sunshine nearly all day while area "C" gets a larger amount of afternoon shade. Area "B" has a total of 10 sprinklers and a total demand of about 14 gpm (3,18 m<sup>3</sup>/h or 0,88 L/s), while the six sprinklers for area "C" require approximately 6 gpm (1,36 m<sup>3</sup>/h or 0,38 L/s). Because 14 gpm (3,18 m<sup>3</sup>/h or 0,88 L/s) is greater than the 10 gpm (2,27 m<sup>3</sup>/h or 0,63 L/s) available flow, it is necessary to create two valves.

Area "D" is a drip irrigation zone. To calculate the required flow for the lateral, the designer completed the following calculations. The number of shrubs was multiplied by the number of emitters per shrub. That result was then multiplied by the flow of an emitter to produce the number of gallons per hour (liters per hour) in the area. To convert to the more typical gallons per minute (liters per second), the flow is divided by 60 (3600). Because area "D" has 25 shrubs with two emitters per shrub, the calculation looks like this:

$$\begin{aligned} 25 \text{ shrubs} \times 2 \text{ emitters/shrub} &= 50 \text{ emitters} \\ 50 \text{ emitters} \times 1 \text{ gph (4 L/h)} &= 50 \text{ gph (200 L/h)} \\ 50 \text{ gph}/60 \text{ min/h} &= .833 \text{ gpm or almost 1 gpm} \\ (200 \text{ L/h}/3600 \text{ s/h}) &= 0,0555 \text{ L/s or almost 0,06 L/s} \end{aligned}$$

Area "E" is another shrub bed with drip irrigation. The calculations for the flow are a little more complex because there are trees present in this bed. Trees are irrigated with a six port multi-outlet emitter which has four ports open. The flow for the trees is calculated like the shrubs, but with four emitters instead of two. Therefore the calculations are:

$$\begin{aligned} 34 \text{ shrubs} \times 2 \text{ emitters per shrub} &= 68 \text{ emitters} \\ 68 \text{ emitters} \times 1 \text{ gph (4 L/h)} &= 68 \text{ gph (272 L/h)} \\ 3 \text{ trees} \times 4 \text{ emitters per tree} &= 12 \text{ emitters} \\ 12 \text{ emitters} \times 1 \text{ gph (4 L/h)} &= 12 \text{ gph (48 L/h)} \end{aligned}$$

The trees and shrub flows are added together and divided by 60 minutes (3600 seconds) to obtain the gallons per minute (liters per second):

$$\begin{aligned} 68 \text{ gph} + 12 \text{ gph} &= 80 \text{ gph (272 L/h + 48 L/h = 320 L/h)} \\ 80 \text{ gph} \div 60 \text{ min} &= 1.3 \text{ gpm (320 L/h} \div 3600 \text{ sec} = 0,0888 \text{ L/s or 0,09 L/s)} \end{aligned}$$

Area "F" is a full-sun lawn area that accounts for most of the space in the back yard. There are 45 sprinklers in the yard, with a total flow (when evaluated as a group) of a little over 100 gpm (22,68 m<sup>3</sup>/h or 6,31 L/s). With our maximum available flow of 10 gpm (2,27 m<sup>3</sup>/h or 0,63 L/s) this means that there will be a minimum of 10 or 11 valves to cover the area. The designer has tried to keep the same kind of sprinklers together on the valves. This means that full circle sprinklers are on different laterals than part circle sprinklers. While most pop-up sprays have matched precipitation rates, keeping fulls and parts separate allows the homeowner the ability to have more control of the irrigation system. Often areas along a wall or fence require less water than those in the center of the turf, because of shade or screening from wind.

Area "G," a semi-circular area of perennials and trees, will be irrigated by variable arc nozzles on 12 in (30,5 cm) pop-ups. Total flow for the six sprinklers is 5 gpm (1,13 m<sup>3</sup>/h or 0,32 L/s).

Area "H" is another drip zone. There are 15 shrubs and four trees in this area. Flow calculations are:

$$\begin{aligned} 15 \text{ shrubs} \times 2 \text{ emitters per shrub} &= 30 \text{ emitters} \\ 30 \text{ emitters} \times 1 \text{ gph (4 L/h)} &= 30 \text{ gph (120 L/h)} \\ 4 \text{ trees} \times 4 \text{ emitters per tree} &= 16 \text{ emitters} \\ 16 \text{ emitters} \times 1 \text{ gph (4 L/h)} &= 16 \text{ gph (64 L/h)} \\ 30 \text{ gph (120 L/h)} + 16 \text{ gph (64 L/h)} &= 46 \text{ gph (184 L/h)} \\ 46 \text{ gph (184 L/h)} \div 60 \text{ min (3600 sec)} &= .76 \text{ gpm (0,05 L/s)} \end{aligned}$$

Area "I" has two perennial beds, one of which is near a window. To minimize over spray onto the house, but still use sprays for the perennials, the designer selected micro-sprays. Here, the low-flow spray heads are used with 12 in (30,5 cm) pop-up sprays. Using the high pop-ups allows the sprays to be up high enough to be effective, but retract out of the way when the irrigation is complete. Radius and flow for each of the sprays can be controlled by a ball valve that is built into the device. Maximum flow for each xeri-spray is 0.52 gpm (0,12 m<sup>3</sup>/h or 0,02 L/s), which when

# Lateral Layout, Circuiting Sprinklers in Valve Groups

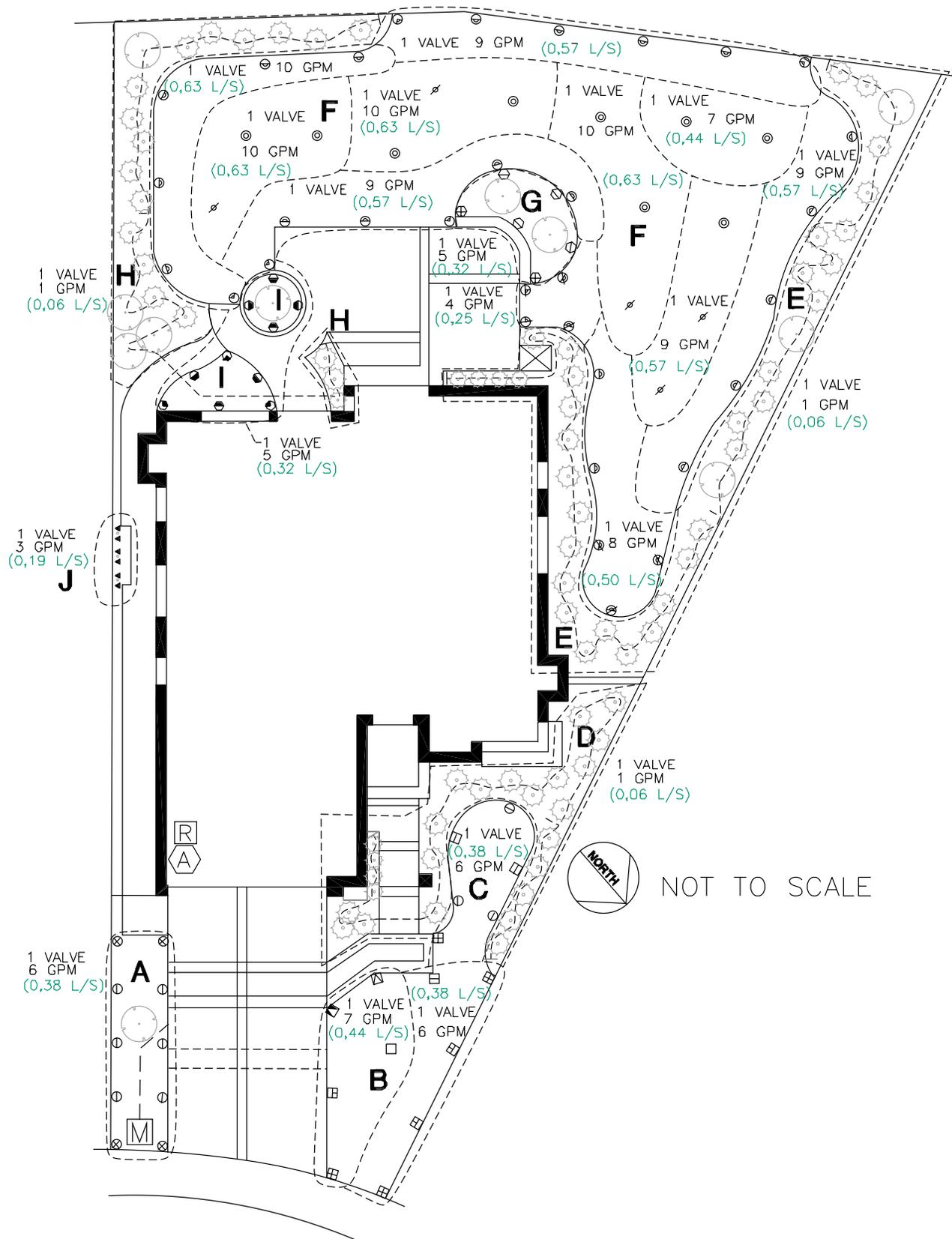

Figure 52: Plan, lateral layout

multiplied by the 10 devices, produces a total flow of about 5 gpm (1,13 m<sup>3</sup>/h or 0,32 L/s).

Finally, area “J” has three climbing plants that are irrigated by flood bubblers on risers. The designer has chosen the 1402 0.5 gpm (0,11 m<sup>3</sup>/h or 0,03 L/s) bubbler. Risers are used here since the plants are in a very low traffic area.

After adding up all the areas, there are 21 valves. Because this is to be an automatic system, the project will require a controller that can handle a minimum of 21 remote control valves. Though some of the laterals are small enough (low flow) for the main line to support more than one operating at a time, the differing watering times and frequencies require separate valving.

### Locating valves, main lines and lateral piping

Locating the valves, main lines and lateral piping is the next part of the design process. Here are some factors that will help guide the placement of these components:

- **Valves should be accessible for maintenance and servicing.** Valves installed below ground should be housed in valve boxes and not buried directly in the ground.
- **The valves and/or valve boxes should be located where they will not interfere with normal traffic or use of the area** (i.e., a valve box lid on the surface of a football field is unacceptable).
- **Manual valves need to be located where the system owner can conveniently reach them for operation**, but not where the sprinklers will douse the operator.
- **Where possible, the valve serving a group of sprinklers should be at the center of the group to balance the flow and size of lateral pipe.**
- **Normally, a valve should be the same size as the lateral line it serves.** Even under special conditions, the valve should not be sized more than one nominal size smaller or larger than the largest size of its lateral.
- **Valve and main line locations should be kept in mind when circuiting sprinklers and drawing in lateral pipe routes.**
- **Main line pipes are the most expensive pipes; minimize the length of the main line pipe route were possible.**
- **If convenient, the main line and lateral lines can share the same trench in some areas of the project to reduce labor costs.** To minimize the possibility of damage from over sprinkle, the main line should have adequate cover.

Here are some examples of circuiting the sprinklers into valve and lateral pipe configurations in relation to the rules mentioned above.

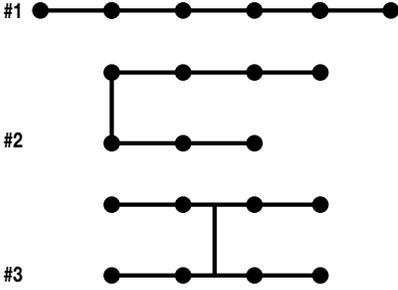

Figure 53: Straight line lateral valve configurations

The **straight line lateral circuit**, where the valve is located at the extreme end of the line, is the least optimum of all lateral designs.

As we learned in the basic hydraulics section of this program, when sizing pipe by the 5 ft/s (1,5 m/s) method, the portion of the pipe that feeds all the sprinklers would be the largest. There are several other lateral circuit configurations that could reduce the size of the pipe required while supplying the same number and type of sprinklers. Pressure differences between the sprinklers on the extreme ends of the lateral are the greatest in this method. This can cause large variations in discharge and performance between the sprinklers.

The **split-length lateral circuit**, where the valve is located in the center of the line of sprinklers, has several advantages over the straight line lateral circuit.

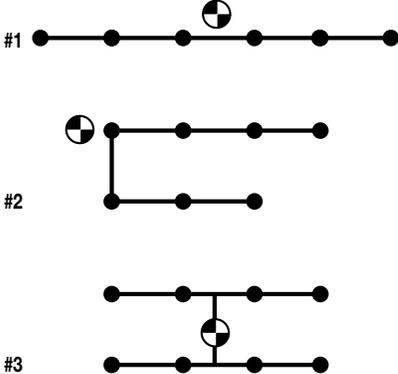

Figure 54: Split-length lateral configurations

The total flow for the circuit is split in half, which can often reduce the size of pipe required and balance the pressure losses throughout the circuit. Balanced loss reduces variation in sprinkler performance because of more uniform pressure availability.

## Lateral Layout, Circuiting Sprinklers in Valve Groups

Even two-row sprinkler circuits can be split to reduce pressure variations, balance flows and reduce pipe sizes. Here are just a few:

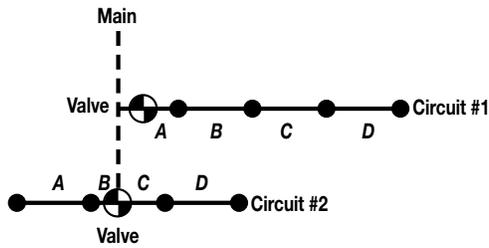

Figure 55: Two row sprinkler circuits

A deep “U” shaped circuit can often be used to reach into planter boxes or other areas without having the valve and main line enter the area.

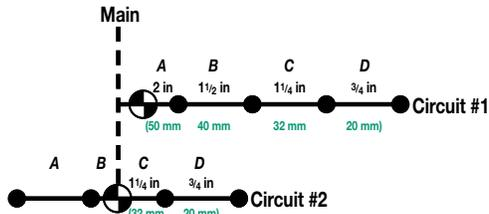

Figure 56: Deep U-shape circuits

Even with an odd number of sprinklers, circuit routes and valve locations can be selected to minimize pressure loss and pipe sizes.

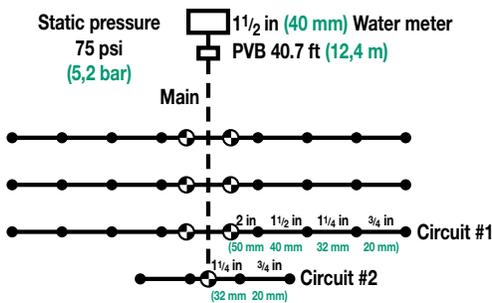

Figure 57: Odd number circuits, example one

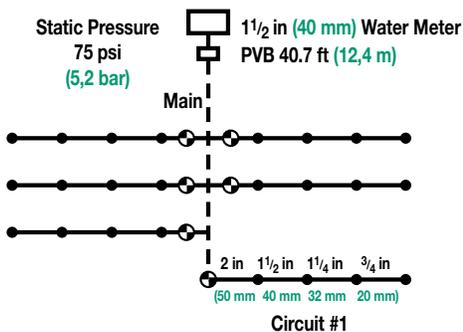

Figure 58: Odd number circuits, example two

There are many other possible lateral pipe configurations, but the goals of the layout are the same. Minimizing pressure changes, balancing flows, minimizing pipe sizes and size changes, and locating the valve where it won't be in the way, all play a part in lateral circuit design.

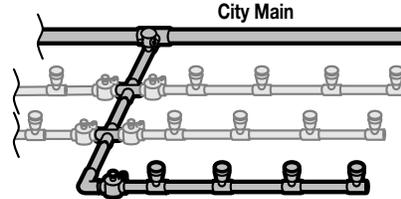

Figure 59: Main line/lateral line configuration

Let's look at a few of the piping configurations the designer used for the circuits on this project. Area “A,” is basically an “H” pattern. Area “C” is a U-shaped pattern. As you look at the rest of the circuit designs on the project, keep in mind that there are many ways to do each one.

### Calculating lateral operating time

Sometime during the stage of the design following sprinkler layout, the designer has an opportunity to calculate the lateral operating time for the various types of sprinklers to be installed on the project. There is an important reason for determining the average operating time for the system. Back in step two, we determined the maximum irrigation requirement in inches per day or per week for the type of climate influencing the project site. Now we need to know if the circuits we are designing can meet this requirement in the time available for irrigation.

If the time available for irrigation is limited, the type of sprinklers used, how they are circuiting and the number of laterals that can run at the same time are critical concerns. For example, a golf superintendent's nightmare is a golf course irrigation system that cannot irrigate the entire course over night.

The process for testing the adequacy of the system is to determine the daily watering time (in minutes) each circuit will need to eventually satisfy the weekly irrigation requirement for the project. A simple formula applied to each type of circuit will help the designer determine the daily average operating time needed.

The formula looks like this:

$$OT = \frac{I \times 60}{PR \times DA}$$

For this formula:

- OT = Circuit operating time in minutes per day
- I = System irrigation requirement in inches (millimeters) per week in the “worst case” season
- PR = Circuit precipitation rate in inches (millimeters) per hour
- DA = Days available for irrigation per week
- 60 = Constant conversion factor of 60 min/h

Let’s look at the formula in action on some sample circuits.

### Sample lateral number 1

- System irrigation requirement: 1-1/2 in (38 mm) per week
- Days available for irrigation: 3 days
- Sprinkler performance: 3.5 gpm (0,79 m<sup>3</sup>/h) full circle, radius = 14 ft (4 m)
- Sprinkler spacing: 13 x 15 ft (4 m x 5 m) rectangular

First, if not previously calculated, determine the precipitation rate of the circuit.

$$PR = \frac{96.3 \times 3.5 \text{ gpm}}{13 \text{ ft} \times 15 \text{ ft}} = 1.73 \text{ in/h} \quad \left( PR = \frac{1000 \times .79 \text{ m}^3/\text{h}}{4 \text{ m} \times 5 \text{ m}} = 39,5 \text{ mm/h} \right)$$

Next, insert all the data into the formula and calculate the daily minutes of operating time for the circuit.

$$OT = \frac{1.5 \text{ in/wk} \times 60 \text{ min/h}}{1.73 \text{ in/h} \times 3 \text{ day/wk}} = 17.3 \text{ or } 18 \text{ min/day, } 3 \text{ day/wk}$$

$$\left( OT = \frac{38 \text{ mm/wk} \times 60 \text{ min/h}}{39,5 \text{ mm/h} \times 3 \text{ day/wk}} = 19,2 \text{ or } 19 \text{ min/day, } 3 \text{ day/wk} \right)$$

### Sample lateral number 2

- System irrigation requirement: 1-1/2 in (38 mm) per week
- Days available for irrigation: 3 days
- Sprinkler performance: 4.5 gpm (1 m<sup>3</sup>/h) full circle, radius = 40 ft (12 m)
- Sprinkler spacing: 40 ft x 45 ft (12 m x 14 m) rectangular

Circuit precipitation rate calculation:

$$PR = \frac{96.3 \times 4.5 \text{ gpm}}{40 \text{ ft} \times 45 \text{ ft}} = .24 \text{ in/h} \quad \left( PR = \frac{1000 \times 1 \text{ m}^3/\text{h}}{12 \text{ m} \times 14 \text{ m}} = 6 \text{ mm/h} \right)$$

Circuit operating time:

$$OT = \frac{1.5 \text{ in/wk} \times 60 \text{ min/h}}{.24 \text{ in/h} \times 3 \text{ day/wk}} = 125 \text{ min/day, } 3 \text{ day/wk}$$

$$\left( OT = \frac{38 \text{ mm/wk} \times 60 \text{ min/h}}{6 \text{ mm/h} \times 3 \text{ day/wk}} = 126 \text{ min/day, } 3 \text{ day/wk} \right)$$

Once the operating time for each type of circuit is established, the next step is to add up all the circuits on the

system and check this total against the hours of irrigation time available each day. If the system is for a ball field or park, then the night time hours are, most likely, the only irrigation hours available since the facility is in use during the day.

The time period available for irrigation is called the **water window**.

The 125 min (126 min—the difference is caused by rounding during the International System Units calculation) in the second operating time example, equals two hours and five minutes of running time per day for each circuit on the project similar to that one. What happens if there are 12 such circuits? If only one circuit can operate at a time, that means it takes 25-hour day to irrigate the project! Even if it wasn’t a day use area, there still are not enough hours in the day to complete a watering cycle.

A number of ways to resolve this problem are implied in the formula variables. If, instead of being fixed numbers, the flow, irrigation days and precipitation rate are flexible, and they are analyzed at the design stage, then there is room to work out a solution to the irrigation time problem.

Perhaps two circuits cannot be run at one time, but maybe the hydraulics of the system would support higher flow rate sprinklers on each circuit. If 3 day/week for watering isn’t an imposed or valid restriction, more irrigation cycles per week would lessen the problem.

Let’s look at what happens if the system will support 7 gpm (1,6 m<sup>3</sup>/h) sprinklers instead of the 4.5 gpm (1 m<sup>3</sup>/h) sprinklers used previously.

$$PR = \frac{96.3 \times 7 \text{ gpm}}{40 \text{ ft} \times 45 \text{ ft}} = .38 \text{ in/h} \quad \left( PR = \frac{1000 \times 1,6 \text{ m}^3/\text{h}}{12 \text{ m} \times 14 \text{ m}} = 9,5 \text{ mm/h} \right)$$

Now the water is being applied faster. What happens to the time required?

$$OT = \frac{1.5 \text{ in/wk} \times 60 \text{ min/h}}{.38 \text{ in/h} \times 3 \text{ day/wk}} = 78.9 \text{ min/day, } 6 \text{ day/wk}$$

$$\left( OT = \frac{38 \text{ mm/wk} \times 60 \text{ min/h}}{9,5 \text{ mm/h} \times 3 \text{ day/wk}} = 80.0 \text{ min/day, } 6 \text{ day/wk} \right)$$

For the 12 circuits on the system, it now takes about 15.8 hours. If this is still too much time, let’s look at increasing the days available for watering to 6 days per week.

$$OT = \frac{1.5 \text{ in/wk} \times 60 \text{ min/h}}{.38 \text{ in/h} \times 6 \text{ day/wk}} = 39.4 \text{ min/day, } 6 \text{ day/wk}$$

$$\left( OT = \frac{38 \text{ mm/wk} \times 60 \text{ min/h}}{9,5 \text{ mm/h} \times 6 \text{ day/wk}} = 40.0 \text{ min/day, } 6 \text{ day/wk} \right)$$

## Lateral Layout, Circuiting Sprinklers in Valve Groups

40 min/station x 12 circuits = 8 hours irrigation time/cycle on the automatic irrigation controller

If this is a day use area, we can get the job done between the night time and early morning hours of 10 p.m. to 6 a.m.

This example is somewhat simplified compared to a real life situation where a number of other factors would require examination. We easily switched to higher flow sprinklers. A designer would have to check to make sure the increased precipitation rate did not exceed the soil's rate of infiltration. The greater flow demand could require the designer to reduce the number of sprinklers per circuit or increase pipe sizes. These, and other considerations pertaining to the project, require review when making alterations of the system to match operating time to the time available for irrigation.

In the previous step, the designer determined how many valve circuits were going to be required on the project and, using the guidelines on circuit design, drew in the lateral pipe and valve positions. These valve positions, if not yet connected, need to be circuited into a total system by drawing in the main line that links them to the water source.

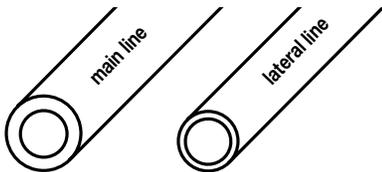

Figure 60: Main line and lateral line

As mentioned earlier, the main line pipe is more expensive than the lateral pipe because it needs to have stronger, heavier, more pressure-resistant walls. The main will be under constant pressure, even when the system is not in use. Unnecessary runs of the main line should be avoided from a cost standpoint. Sufficient cover should be provided for the main to protect it from damage by overhead traffic. Depending on the system main line size, the trench depth should be specified to provide this protection. In a residential design, often the sprinkler main line is about 12 in (30 cm) below the surface. In large-size commercial or industrial irrigation systems, 2 ft (60 cm) of cover is specified for irrigation mains. Golf course mains are often specified for a minimum of 24 in (60 cm) of cover. In climates that have harsh winter freezing conditions, the mains are specified at greater depths or provided with manual drainage valves to avoid trapping water that would become expanding ice.

In the project we have been following, the designer would have preferred to branch the main line, routing one leg of the line straight to the backyard under the walkway at the side of the house. The other leg could have been routed up the right side of the property and stopped where the first valve for section "E" is located. Because the walkway on the left side of the house was already installed, the designer was forced to nearly circle the property with the main line.

After the designer draws in the most economical route for the main line, both from the standpoint of cost and least pressure loss, step six can be started.

Before going to this next step, however, let's practice what you have learned about valve circuit design and calculating operating time. Test your knowledge with the Exercises on Circuit Configuration and Operating Time on the next page. Answers are listed in the Solutions section on page 91.

## 6 Lateral Layout, Circuited Sprinklers into Valve Groups

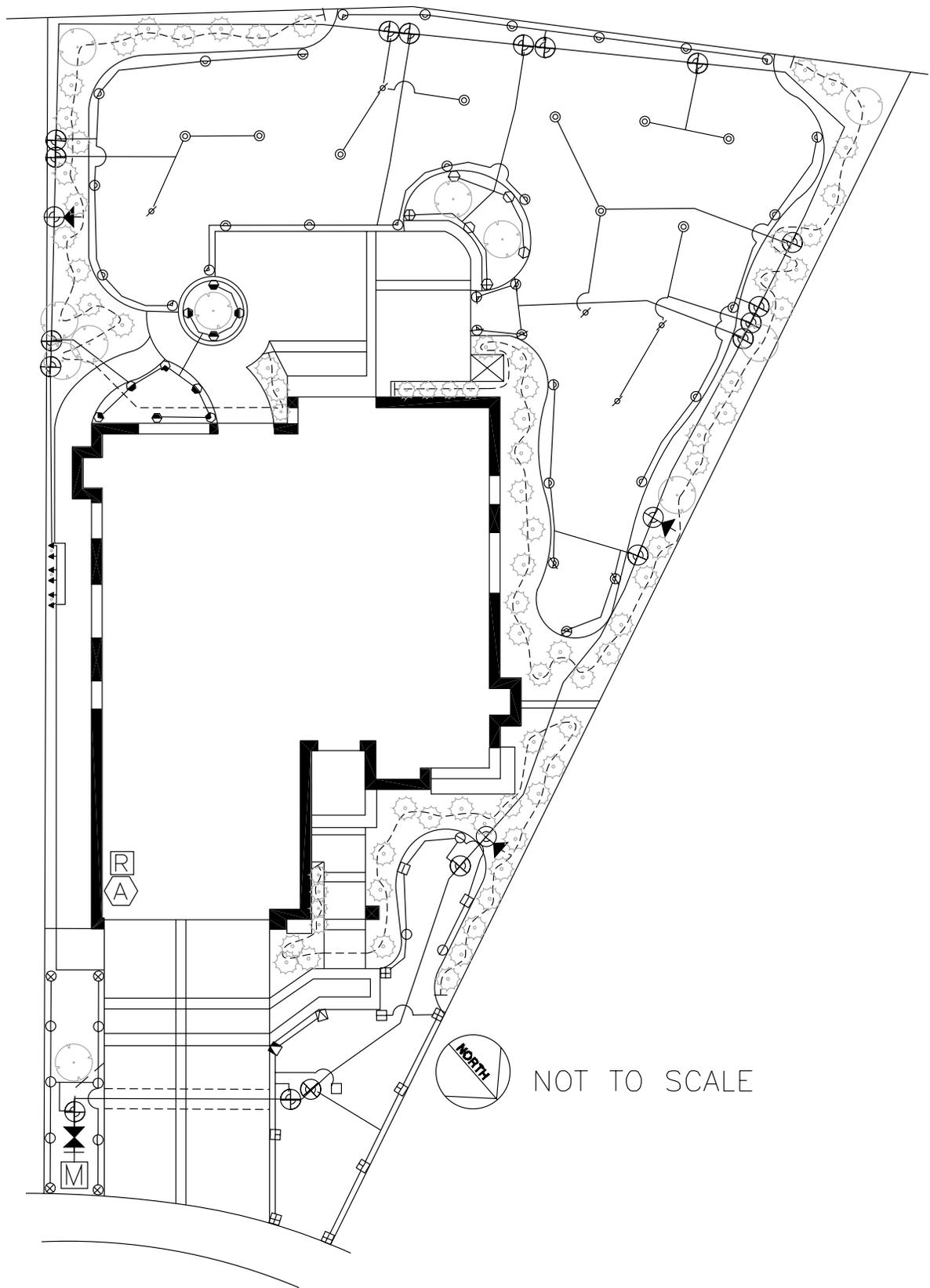
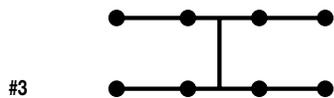
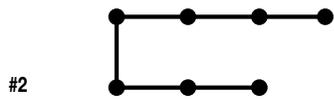

Figure 61: Plan, valve groups

## Lateral Layout, Circuiting Sprinklers in Valve Groups

### Exercises on circuit configuration and operating time

- A. Draw a small circle where the valve should be located in each of the following sprinkler circuits to best balance the flow to all the sprinklers.



- B. What is the operating time per cycle for a circuit with the following characteristics?

No watering is allowed on Wednesday evenings because of regular Little League games.

No watering is allowed during the day.

Sprinkler precipitation rate for the rotors is .33 in/h (8,4 mm/h).

The irrigation requirement is 2 in (50 mm) per week.

$$\frac{? \times 60}{? \times ?} = ? \text{ min/cycle}$$

- C. What would the operating time per cycle be if the precipitation rate for the sprinklers in question "B" was .75 in/h (19 mm/h)?

\_\_\_\_\_ min/cycle

- D. What would the operating time per cycle be if all the original information concerning the circuit in question "B" was the same except for only four days per week available for irrigation?

\_\_\_\_\_ min/cycle

- E. What is the operating time per cycle for a circuit with the following characteristics?

Days per week available for irrigation: 7.

Irrigation requirement per day: .214 in (5 mm).

Sprinkler precipitation rate: .67 in/h (17 mm/h).

$$\frac{? \times 60}{? \times ?} = ? \text{ min/cycle}$$

- F. Adequate \_\_\_\_\_ is required to protect a main line pipe from damage from overhead traffic.

- G. True or false? A main line pipe will usually require thicker walls than a lateral line pipe?

# *Sizing Pipe and Valves and Calculating System Pressure Requirements*

7

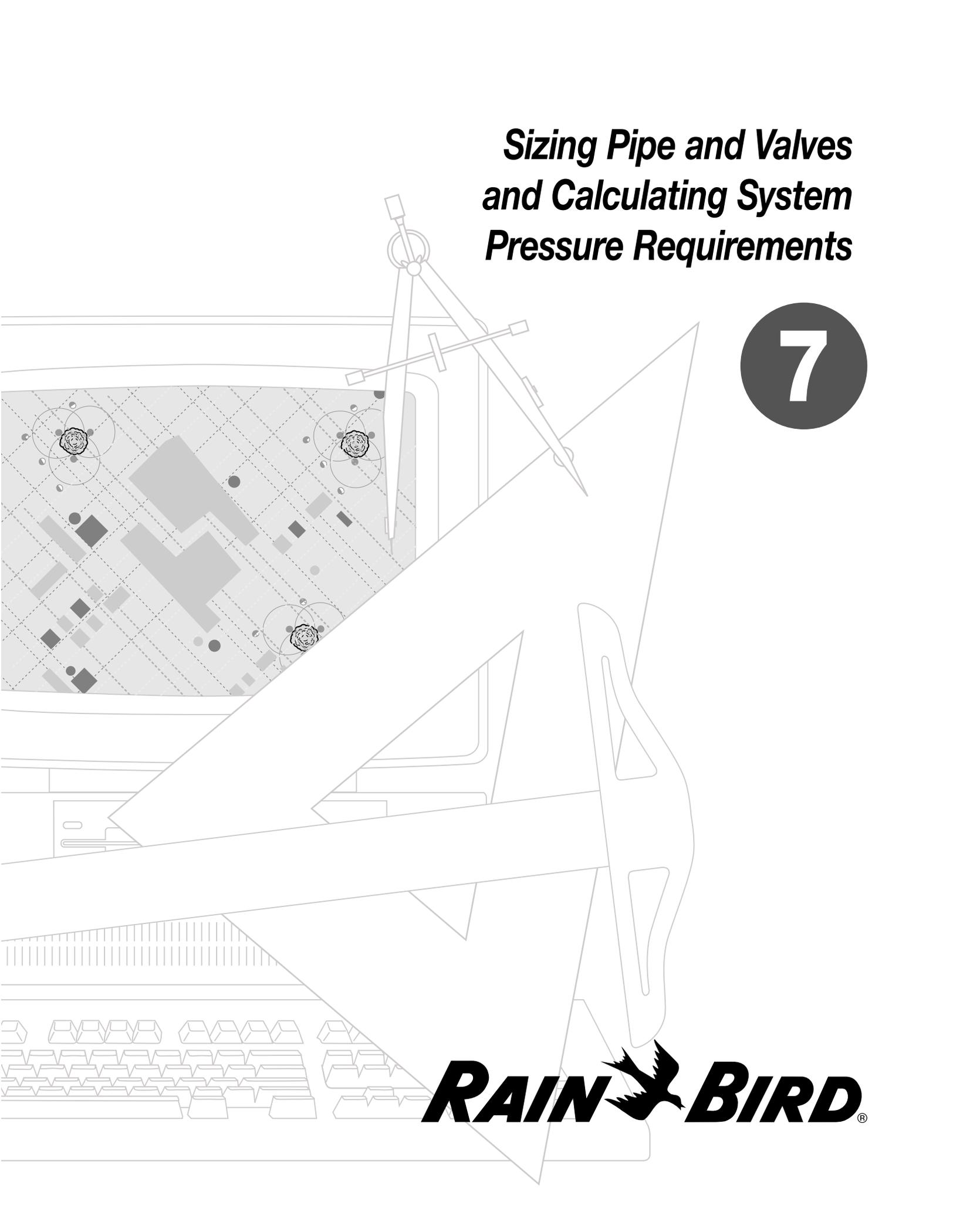

**RAIN  BIRD®**



## Step seven: Sizing pipe and valves and calculating system pressure requirements

In step seven, sizing the pipe and valves in the system and calculating the total system pressure requirement, the designer uses the principles of hydraulics to size all the components in the system and to ensure adequate flow and pressure to properly operate all the sprinklers on the project.

In the Understanding Basic Hydraulics section, we discussed the 5 ft/s (1,5 m/s) velocity safety limit for pipe. To review, at 5 ft/s (1,5 m/s), the speed of the water in the pipe is less likely to cause damaging surge pressures. The second reason for holding velocity at or below 5 ft/s (1,5 m/s) is that friction losses increase dramatically as more water is being forced through the pipe at higher speeds. The simplest way to keep these factors where they can be controlled is to size the pipe in an irrigation plan using the 5 ft/s (1,5 m/s) method. First, examine two typical valve circuits that have not yet had their lateral pipe sizes specified.

Each circuit has four, medium-sized rotor pop-up sprinklers that throw 47 ft (14,33 m) at 55 psi (3,8 bar), and each require 9.8 gpm (2,22 m<sup>3</sup>/h or 0,62 L/s). The designer has spaced them in an equilateral triangular pattern at 50% spacing, but has chosen a different lateral pipe configuration for each circuit. For reference, the various pipe sections of each lateral have an identification letter.

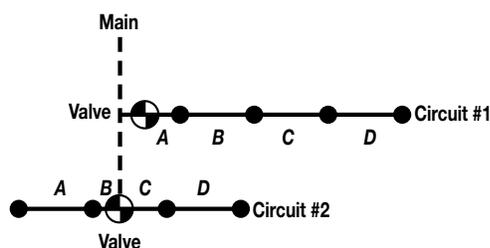

Figure 62: Lateral pipe configuration

The designer knows that the water supply must reach even the furthest sprinkler out on the line with a minimum of 55 psi (3,8 bar) to get the desired performance at the selected spacing. Before sizing the lateral pipes, the designer needs to select what type of pipe to specify. In this case, let's say the designer wanted a medium strength pipe that also had fairly good flow characteristics, and chose Class 200 PVC. Turning to the Class 200 PVC pipe chart, the designer is ready to begin sizing the lateral pipe.

Pipe sizing for a sprinkler lateral is done in reverse. The first pipe to be sized is the pipe reach supplying the last or furthest sprinkler from the valve. When the size has been

established for that reach, the next reach in, supplying the last two sprinklers, should be sized. This process continues, moving backward (or upstream) from the last sprinkler, and toward the valve.

The route this sizing procedure follows along the various pipes in the circuit is called the **critical circuit length**. This route is defined as the longest path in the circuit that the water will have to travel. The critical length may also be described as the length between the valve and the most distal sprinkler.

Looking at Circuit #1 in the example, it's easy to see that the critical circuit length for this lateral includes all the pipe sections, section "A" through section "D." The longest path from the valve to the most distal sprinkler is through all the lateral pipes.

In Circuit #2, the designer has split the lateral with the valve in the center of the circuit. The circuit is not split exactly in half. If it was, the designer could use either side of the circuit as the critical path. There is a slightly longer water path from the valve down through sections "C" and "D" to the furthest sprinkler. Sections "C" and "D," therefore, make up the critical circuit length for example two. With the type of pipe selected and the critical lengths determined, the designer is ready to use the Class 200 PVC pipe chart and the 5 ft/s (1,5 m/s) method to size the lateral lines.

First, let's start with Circuit #1 and, as mentioned earlier, with the last sprinkler on the line which is on the far right. This sprinkler requires a flow of 9.8 gpm (2,22 m<sup>3</sup>/h or 0,62 L/s), but the pipe supplying it cannot have a velocity of more than 5 ft/s (1,5 m/s). Checking the Class 200 PVC pipe chart, the designer looks for the smallest pipe that will carry 9.8 gpm (2,22 m<sup>3</sup>/h or 0,62 L/s) without exceeding the 5 ft/s (1,5 m/s) limit.

The highest flow for 3/4 in (20 mm) Class 200 PVC pipe before going into the shaded area on the chart is 10 gpm (2,27 m<sup>3</sup>/h or 0,63 L/s). The flow demand for the sprinkler, 9.8 gpm (2,22 m<sup>3</sup>/h or 0,62 L/s), can be met by the 3/4 in (20 mm) size with a velocity of about 4.7 ft/s (1,43 m/s). The pipe size specified by the designer for section "D" then is 3/4 in (20 mm).

Working backward toward the valve, section "C" is the next pipe to be sized. This section supplies two sprinklers, each requiring 9.8 gpm (2,22 m<sup>3</sup>/h or 0,62 L/s) for a total flow of 19.6 gpm (4,45 m<sup>3</sup>/h or 1,24 L/s). The pipe chart shows that not only is 3/4 in (20 mm) pipe out of the question, but 1 in (25 mm) pipe is too small also. At nearly 20 gpm (4,54 m<sup>3</sup>/h or 1,26 L/s), this section of the lateral requires 1-1/4 in (40

## Sizing Pipe and Valves and Calculating System Pressure Requirements

mm) pipe to support two sprinklers while adhering strictly to the 5 f/s (1,5 m/s) rule. The designer selects 1-1/4 in (40 mm) for section “C.”

### PVC CLASS 200 IPS PLASTIC PIPE

(1120, 1220) SDR 21 C=150  
PSI loss per 100 feet of pipe (psi/100 ft)

**PVC CLASS 200 IPS PLASTIC PIPE**  
Sizes 3/4 in through 6 in. Flow 1 through 600 gpm.

SIZE	3/4 in	1 in	1 1/4 in	1 1/2 in	2 in
OD	1.050	1.315	1.660	1.900	2.375
ID	0.930	1.189	1.502	1.720	2.149
Wall Thk	0.060	0.063	0.079	0.090	0.113

flow gpm	velocity fps	psi loss	velocity fps	psi loss	velocity fps	psi loss	velocity fps	psi loss	velocity fps	psi loss	velocity fps	psi loss
1	0.47	0.06	0.28	0.02	0.18	0.01	0.13	0.00				
2	0.94	0.22	0.57	0.07	0.36	0.02	0.27	0.01	0.17	0.00		
3	1.42	0.46	0.86	0.14	0.54	0.04	0.41	0.02	0.26	0.01	0.18	
4	1.89	0.79	1.15	0.24	0.72	0.08	0.55	0.04	0.35	0.01	0.24	
5	2.36	1.20	1.44	0.36	0.90	0.12	0.69	0.06	0.44	0.02	0.30	
6	2.83	1.68	1.73	0.51	1.08	0.16	0.82	0.08	0.53	0.03	0.36	
7	3.30	2.23	2.02	0.67	1.26	0.22	0.96	0.11	0.61	0.04	0.42	
8	3.77	2.85	2.30	0.86	1.44	0.28	1.10	0.14	0.70	0.05	0.48	
9	4.25	3.55	2.59	1.07	1.62	0.34	1.24	0.18	0.79	0.06	0.54	
10	4.72	4.31	2.88	1.30	1.80	0.42	1.37	0.22	0.88	0.07	0.60	
11	5.19	5.15	3.17	1.56	1.98	0.50	1.51	0.26	0.97	0.09	0.66	
12	5.66	6.05	3.46	1.83	2.17	0.59	1.65	0.30	1.06	0.10	0.72	
14	6.60	8.05	4.04	2.43	2.53	0.78	1.93	0.40	1.23	0.14	0.84	
16	7.55	10.30	4.61	3.11	2.89	1.00	2.20	0.52	1.41	0.17	0.96	
18	8.49	12.81	5.19	3.87	3.25	1.24	2.48	0.64	1.59	0.22	1.08	
20	9.43	15.58	5.77	4.71	3.61	1.51	2.75	0.78	1.76	0.26	1.20	
22	10.38	18.58	6.34	5.62	3.97	1.80	3.03	0.93	1.94	0.32	1.32	
24	11.32	21.83	6.92	6.60	4.34	2.12	3.30	1.09	2.12	0.37	1.44	
26	12.27	25.32	7.50	7.65	4.70	2.46	3.58	1.27	2.29	0.43	1.56	
28	13.21	29.04	8.08	8.78	5.06	2.82	3.86	1.46	2.47	0.49	1.68	
30	14.15	33.00	8.65	9.98	5.42	3.20	4.13	1.66	2.65	0.56	1.80	
35	16.51	43.91	10.10	13.27	6.32	4.26	4.82	2.20	3.09	0.75	2.11	
40	18.87	56.23	11.54	17.00	7.23	5.45	5.51	2.82	3.53	0.95	2.41	
45			12.98	21.14	8.13	6.78	6.20	3.51	3.97	1.19	2.71	
50			14.42	25.70	9.04	8.24	6.89	4.26	4.41	1.44	3.01	
55		15.87	30.66	9.94	9.83	7.58	7.58	5.09	4.85	1.72	3.31	
60		17.31	36.02	10.85	11.55	8.27	8.27	5.97	5.30	2.02	3.61	
65		18.75	41.77	11.75	13.40	8.96	8.96	6.93	5.74	2.35	3.92	
70				12.65	15.37	9.65	9.65	7.95	6.18	2.69	4.22	
75				13.56	17.47	10.34	10.34	9.03	6.62	3.06	4.52	

Figure 63: Class 200 PVC pipe friction loss characteristics (partial)  
Please see page 110 for a metric version of the chart above.

Section “B” supports three sprinklers at 9.8 gpm (2,22 m<sup>3</sup>/h or 0,62 L/s) each for a total of 29.4 gpm (6,67 m<sup>3</sup>/h or 1,84 L/s). The smallest pipe on the chart that meets the flow needs for the three sprinklers and is within the limit is 1-1/2 in (40 mm) pipe. Having sized section “B” at 1-1/2 in (40 mm), the next section is a short one, section “A.”

Section “A” supports all the sprinklers on the lateral line for a total of four sprinklers at 9.8 gpm (2,22 m<sup>3</sup>/h or 0,62 L/s) each or 39.2 gpm (8,89 m<sup>3</sup>/h or 2,47 L/s). The chart says 2 in (50 mm) pipe is required for section “A” and this last section is sized accordingly.

The critical path for Circuit #1 has been sized. Circuit #2 has the same type of sprinklers and the same type of pipe. Therefore, to support one sprinkler, the designer knows 3/4 in (20 mm) is required for section “D” on this new circuit. Similarly, section “C,” supporting two sprinklers, needs 1-1/4 in (32 mm) pipe. With that decided for Circuit #2, the designer has completed sizing the critical circuit length. Here is how the two circuits look:

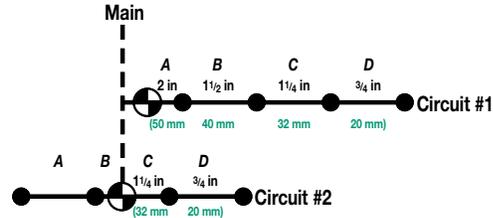

Figure 64: Lateral pipe configuration

After sizing sections “C” and “D” for Circuit #2, the designer also knows the sizes for sections “A” and “B.” Those two sections are nearly a mirror image of sections “C” and “D,” so “A,” which supports one sprinkler, is 3/4 in (20 mm) and “B,” which supports both sprinklers, will be 1-1/4 in (32 mm).

One of the advantages of splitting a sprinkler circuit is clearly evident in the above example. By splitting Circuit #2 and feeding it from a centrally located valve position, the designer has eliminated the need for the two larger pipe sizes. In addition to saving the cost of these bigger pipes, the cost of the larger fittings is gone and, if all the circuits of this size were similar, the contractor could standardize the materials inventory for the project. The circuit is also balanced with less pressure variation between sprinklers.

Now that we have sized these laterals, let’s have a look at the piping plan for this entire sample system.

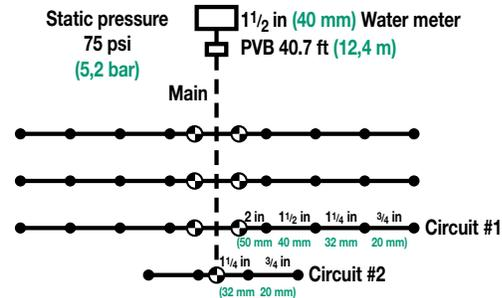

Figure 65: Piping plan

Static pressure: 75 psi (5,2 bar)  
55 psi (3,8 bar) at sprinklers  
40.7 ft (12,4 m) between laterals  
47 ft (14,3 m) between sprinklers  
9.8 gpm (2,22 m<sup>3</sup>/h or 0,62 L/s) per sprinkler

The main line has not yet been sized, nor has a component on the line just after the water meter — the backflow preventer. Backflow is the unwanted reverse flow of water in a piping system. A backflow preventer, of which there are several types, is a valve or valve assembly that physically blocks the potentially contaminated water in the irrigation system from flowing back into the domestic water supply.

## 7 Sizing Pipe and Valves and Calculating System Pressure Requirements

This backflow prevention device, along with all the pipe and electric valves on the system, will need to be sized.

The designer begins by sizing the lateral valves. Because all the circuits require the same flow of 39.2 gpm (8,89 m<sup>3</sup>/h or 2,47 L/s), this only has to be done once. A few guidelines to assist you in sizing valves are listed below.

- **The flow through the valve should not produce a loss greater than 10% of the static pressure available in the main line.**
- **The valve should either be the same size as the largest pipe in the lateral it serves, or no more than one nominal size smaller than that pipe.**
- **The valve should not be larger than the pipes in the lateral, unless a high flow (equivalent to a larger size pipe) results from a split lateral.**

In this sample rotor pop-up system, the static pressure at the meter is 75 psi (5,17 bar). If there are no elevation changes, then, when we have 75 psi (5,17 bar) static in the main as well when no water is flowing. We know too, what size pipes the valve for each circuit will be serving. So let's size the valves for this system.

In your equipment catalog, under valves, turn to the PEB Series electric remote control valves. These units are high-pressure, plastic, 24 volt valves available in three sizes. With a flow of 40 [39.2] gpm (9,07 m<sup>3</sup>/h or 2,52 L/s) established for each circuit we can begin our selection. Rule one says we cannot create a loss through the valve of more than 10% of the 75 psi (5,17 bar) static pressure when flowing the 40 gpm (9,07 m<sup>3</sup>/h or 2,52 L/s).

Looking at the performance chart for the PEB series valves (see page 68), we search for a size with a loss equal to or less than 7.5 psi (0,52 bar) when flowing 40 gpm (9,07 m<sup>3</sup>/h or 2,52 L/s). At that flow, the 1 in valve has a loss of 9.3 psi (0,64 bar), which is too high for this system. The next size up, 1-1/2 in (40 mm), shows a loss of 1.9 psi (0,13 bar) at 40 gpm (9,07 m<sup>3</sup>/h or 2,52 L/s) flow. This size fits our 10% or less static pressure loss rule.

Rule number two says the valve should be the same size, or not more than one nominal size smaller, than the largest pipe in the lateral. Sample Circuit #1 calls for the valve to feed a 2 in (50 mm) pipe. The 1-1/2 in valve satisfies this rule, being one size smaller than the pipe served.

Rule number three applies to sample Circuit #2. Because the designer split the circuit to balance the flow and reduce

the pipe sizes, a circuit using 1-1/4 in (32 mm) pipe with flows equivalent to a neighboring circuit using 2 in (50 mm) pipe was created. The 1-1/2 in valve will be larger than the lateral it serves, however, the flow justifies using that size unit.



Figure 66: Remote control valve

One caution about over-sizing automatic valves: occasionally, a designer, dealing with low pressures to begin with, will look for ways to reduce pressure loss. If the designer selects a large size valve because the flow loss is so low as to be unlisted on the performance chart, he or she may find the valve won't operate once the system is installed. There must be a minimum pressure loss through most types of automatic valves! The valves use this pressure differential to open and close. Lack of data in the manufacturer's performance chart is an indicator that the valve should not be used at the high or low flows in question.

Getting back to our sample rotor job, we have selected the 150-PEB, 1-1/2 in valve, for Circuits #1 and #2. The rest of the circuits on the plan are just like Circuit #1, so all the valves on the project will be 150-PEB valves. If there were circuits requiring various flows on the project, they would use differing valve sizes, selected using the same sizing rules.

The main line from the meter to the last valve now needs to be sized. Main lines need good, high-strength walls because they are under constant pressure. Let's say the designer has chosen Schedule 40 PVC pipe. Turning to that chart in the Technical Data section, the designer would look for the smallest size that will flow 40 gpm (9,07 m<sup>3</sup>/h or 2,52 L/s) at a velocity of 5 ft/s (1,5 m/s) or less.

## PVC SCHEDULE 40 IPS PLASTIC

(1120, 1220) C=150  
PSI loss per 100 feet of pipe (psi/100 ft)

**PVC CLASS 40 IPS PLASTIC PIPE**  
Sizes ½ in through 6 in. Flow 1 through 600 gpm.

SIZE	½ in	¾ in	1 in	1¼ in	1½ in
OD	0.840	1.050	1.315	1.660	1.900
ID	0.622	0.824	1.049	1.380	1.610
Wall Thk	0.109	0.113	0.133	0.140	0.145

flow gpm	velocity fps	psi loss	velocity fps	psi loss	velocity fps	psi loss	velocity fps	psi loss	velocity fps	psi loss	velocity fps	psi loss
1	1.05	0.43	0.60	0.11	0.37	0.03	0.21	0.01	0.15	0.00		
2	2.11	1.55	1.20	0.39	0.74	0.12	0.42	0.03	0.31	0.02	0.19	
3	3.16	3.28	1.80	0.84	1.11	0.26	0.64	0.07	0.47	0.03	0.28	
4	4.22	5.60	2.40	1.42	1.48	0.44	0.85	0.12	0.62	0.05	0.38	
5	5.27	8.46	3.00	2.15	1.85	0.66	1.07	0.18	0.78	0.08	0.47	
6	6.33	11.86	3.60	3.02	2.22	0.93	1.28	0.25	0.94	0.12	0.57	
7	7.38	15.77	4.20	4.01	2.59	1.24	1.49	0.33	1.10	0.15	0.66	
8	8.44	20.20	4.80	5.14	2.96	1.59	1.71	0.42	1.25	0.20	0.76	
9	9.49	25.12	5.40	6.39	3.33	1.97	1.92	0.52	1.41	0.25	0.85	
10	10.55	30.54	6.00	7.77	3.70	2.40	2.14	0.63	1.57	0.30	0.95	
11	11.60	36.43	6.60	9.27	4.07	2.86	2.35	0.75	1.73	0.36	1.05	
12	12.65	42.80	7.21	10.89	4.44	3.36	2.57	0.89	1.88	0.42	1.14	
14	14.76	56.94	8.41	14.48	5.19	4.47	2.99	1.18	2.20	0.56	1.33	
16	16.87	72.92	9.61	18.55	5.93	5.73	3.42	1.51	2.51	0.71	1.52	
18	18.98	90.69	10.81	23.07	6.67	7.13	3.85	1.88	2.83	0.89	1.71	
20	21.09	110.23	12.01	28.04	7.41	8.66	4.28	2.28	3.14	1.08	1.90	
22			13.21	33.45	8.15	10.33	4.71	2.72	3.46	1.29	2.10	
24			14.42	39.30	8.89	12.14	5.14	3.20	3.77	1.51	2.29	
26			15.62	45.58	9.64	14.08	5.57	3.17	4.09	1.75	2.48	
28			16.82	52.28	10.38	16.15	5.99	4.25	4.40	2.01	2.67	
30			18.02	59.41	11.12	18.35	6.42	4.83	4.72	2.28	2.86	
35					12.97	24.42	7.49	6.43	5.50	3.04	3.34	
40					14.83	31.27	8.56	8.23	6.29	3.89	3.81	
45					16.68	38.89	9.64	10.24	7.08	4.84	4.29	
50					18.53	47.27	10.71	12.45	7.87	5.88	4.77	
55							11.78	14.85	8.65	7.01	5.25	
60							12.85	17.45	9.44	8.24	5.72	
65							13.92	20.23	10.23	9.56	6.20	

Figure 67: PVC Schedule 40 friction loss characteristics (partial)  
Please see page 108 for a metric version of the chart above.

## PEB Series

Valve pressure loss\* (psi)

Flow gpm	100-PEB 1 in	150-PEB 1½ in	200-PEB 2 in
0.25	3.0	—	—
0.5	3.0	—	—
1.	3.0	—	—
5.	2.0	—	—
10.	1.5	—	—
20.	2.5	1.5	—
30.	5.0	1.5	—
40	9.3	1.9	—
50.	15.5	2.2	1.2
75.	—	3.9	2.4
100.	—	7.0	4.2
125.	—	11.3	6.8
150.	—	16.2	9.8
175.	—	—	13.3
200.	—	—	17.7

\* Loss values are with flow control fully open.

Figure 68a: Valve pressure loss PEB series (U.S. Standard measure)

## PEB Series

Valve pressure loss\* (bar)

Flow L/s	Flow m³/h	100-PEB 1 in	150-PEB 1½ in	200-PEB 2 in
0,02	,60	0,21		
0,28	1	0,15		
0,56	2	0,10		
0,83	3	0,12		
1,11	4	0,16		
1,39	5	0,21	0,10	
1,67	6	0,27	0,12	
1,94	7	0,35	0,14	
2,22	8	0,45	0,15	
2,50	9	0,59	0,16	
2,78	10	0,77	0,17	
3,33	12		0,18	0,09
3,89	14		0,19	0,12
4,44	16		0,23	0,15
6,11	22		0,46	0,26
7,77	28		0,75	0,44
9,44	34		1,12	0,66
11,10	40			0,93
12,60	45			1,27

\* Loss values are with flow control fully open.

Figure 68b: Valve pressure loss PEB series (International System Units)

The first pipe size that shows 40 gpm (9,07 m³/h or 2,52 L/s) above its shaded area on the chart is 2 in (50 mm). The main line is, therefore, specified as 2 in (50 mm) Schedule 40 PVC pipe.

The last component in this system to be sized is the pressure vacuum breaker or backflow prevention device. The main guideline for the optimal sizing of a backflow preventer is that the flow demanded by your system falls somewhere near the center of the pressure loss curve on the chart for the size you select. If you select a device size that will be using the top of its flow capacity (highest area on its curve), the service life of the unit will be shortened because of the high flow wear on its internal parts. On the other hand, if you select a device size where the system flow is at the very bottom of the backflow preventer's chart, the system owner is paying for a larger device than is needed. On occasion, a somewhat larger device is selected for the specific purpose of reducing friction losses in the system.

Consider the performance data, as shown, for the PVB Series pressure vacuum breakers. Looking at the flow loss charts, we see that the flow of 40 gpm (9,07 m³/h or 2,52 L/s) for our sample rotor system is too high for the ¾ in (20 mm) device—the chart peaks at 35 gpm (7,94 m³/h or 2,21 L/s). The 40 gpm (9,07 m³/h or 2,52 L/s) flow falls at the end of the mid-range on the curve for the 1 in (25 mm) device and the lower part of the center section for the 1-1/4 in (32 mm) PVB.

# 7 Sizing Pipe and Valves and Calculating System Pressure Requirements

The 40 gpm (9,07 m<sup>3</sup>/h or 2,52 L/s) position on the curves for the 1-1/2 in (40 mm) and 2 in (50 mm) devices show that they are larger than needed for this system.

One thing to keep in mind is that local codes prevail on the type and size of backflow prevention device to use for various applications. Always check with the appropriate authorities before specifying the device for your project. Quite often, the code will require that the backflow prevention device be the same nominal size as the service line or POC.



Figure 69: Pressure vacuum breaker

**MODELS: 3/4 in (20 mm) PVB-075, 1 in (25 mm) PVB-100**

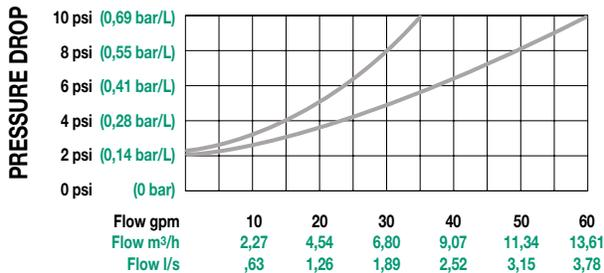

**MODELS: 1 1/4 in (32 mm) PVB-150, 1 1/2 in (32 mm) PVB-150, 2 in (50 mm) PVB-200**

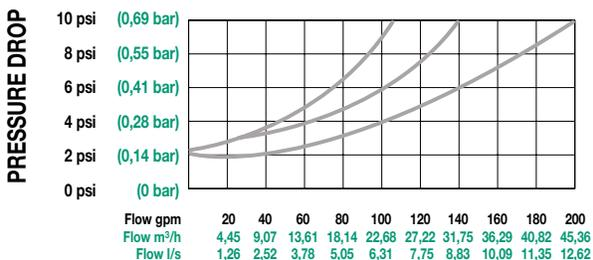

Figure 70: Pressure vacuum breaker flow loss

So, for this particular system, the designer must choose between the 1 in (25 mm) or the 1-1/4 in (32 mm) pressure vacuum breaker. The designer may choose either, but assume the lower pressure loss of about 3.8 psi (0,26 bar) for the 1-1/4 in (32 mm) PVB was more attractive to the designer than the 6.3 psi (0,43 bar) loss for the 1 in (25 mm) device.

The designer has sized the last component in the system and is now ready to determine the system's total pressure requirement. To make sure the system will work, the designer will see how much pressure is needed to operate the system at the flow demanded and subtract that pressure from the static pressure available.

As a simple equation, the process looks like this:

$$Pr = Ps - (Po + Pls)$$

Ps = Static pressure

Po = Operating pressure for "worst case" sprinkler

Pls = Pressure loss throughout system main line and "worst case" lateral circuit

Pr = Pressure remaining after satisfying the total system requirement

The designer begins this process by finding the "worst case" lateral which is the lateral that is most distal from the POC, or a distant lateral with the highest flow, or a high-flow lateral at a high elevation in the project. Finding the "worst case" lateral may, in fact, require a hydraulic check of several laterals to determine which has the actual "worst case" conditions. When the "worst case" lateral is known, then the "worst case" sprinkler must be determined. The "worst case" sprinkler is the one furthest from the lateral valve.

In the case of our sample rotor system, the "worst case" circuit could be either Circuit #1 or Circuit #2. Both circuits are flowing the same amount; however, Circuit #2 is about 40 ft (12,19 m) farther out on the main line. But, Circuit #1 has a longer run of lateral pipe than the split run of Circuit #2. One quick way to check out the system without having to calculate the losses for each of these two circuits is to calculate the losses for Circuit #1 as if it were positioned where Circuit #2 is.

This imaginary positioning creates an even worse-case circuit than actually exists. If our calculations of the system pressure requirement shows we have the pressure to make this circuit work, we know everything else will also work. All other circuits will be sized the same and will be closer to the supply.

If the resulting pressure is a very low number or a negative number, the designer would know at the time, instead of after installation, that to work properly, the system design requires more pressure than the project has available. At that point, while the system is still on paper, the designer could change sprinklers, lower flow requirements, add valves, increase pipe sizes, or do whatever is necessary to reduce the pressure requirements of the hydraulic design. Some irrigation systems will require a booster pump to increase pressure from the POC.

## Sizing Pipe and Valves and Calculating System Pressure Requirements

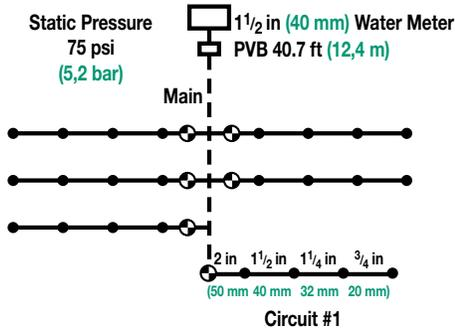

Figure 71: Worst case circuit

Calculate the system pressure requirement for this sample plan of rotor pop-ups and see if it will work.

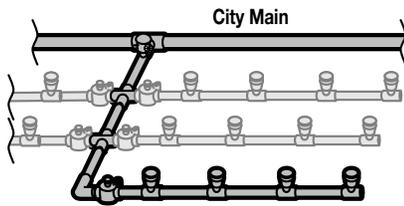

Figure 72: Sample plan with rotor pop-ups

Fill in the blanks at the end of this section as you use your calculator and the Technical Data section of this manual to follow this Total Pressure Requirement procedure. Answers are in the Solutions section on page 91.



## Sizing Pipe and Valves and Calculating System Pressure Requirements

### Exercises on calculating system pressure requirements

The procedure is outlined below to work backward from the “worst case” sprinkler of the “worst case” lateral, and hence all the way through the system main line until we determine the minimum pressure requirement (75 psi [5,17 bar] in front of the water meter). In this case, we created an imaginary “worst case” lateral by calculating losses as if Circuit #1 was farther out on the main line where Circuit #2 is. Remember this change if, after filling in the blanks, you wish to follow the critical length of the system we are analyzing.

Fill in the blanks. Assume the site is flat and has no elevation change.

*Pressure needed at sprinkler = 55 psi (3,79 bar)*

Pressure loss:

- for 9.8 gpm (2,22 m<sup>3</sup>/h or 0,62 L/s) through 47 ft (14,3 m) of 3/4 in (20 mm) Class 200 PVC pipe \_\_\_\_\_ +
  - for 19.6 gpm (4,45 m<sup>3</sup>/h or 1,24 L/s) through 47 ft (14,3 m) of 1-1/4 in (32 mm) Class 200 PVC pipe \_\_\_\_\_ +
  - for 29.4 gpm (6,67 m<sup>3</sup>/h or 1,85 L/s) through 47 ft (14,3 m) of 1-1/2 in (40 mm) Class 200 PVC pipe \_\_\_\_\_ +
  - for 39.2 gpm (8,89 m<sup>3</sup>/h or 2,47 L/s) through 23.5 ft (7,2 m) of 2 in (50 mm) Class 200 PVC pipe \_\_\_\_\_ +
  - for 39.2 gpm (8,89 m<sup>3</sup>/h or 2,47 L/s) through a 150-PEB, 1-1/2 in electric valve \_\_\_\_\_ +
  - for 39.2 gpm (8,89 m<sup>3</sup>/h or 2,47 L/s) through 162.8 ft (50 m) of 2 in (50 mm) Schedule 40 PVC pipe \_\_\_\_\_ +
- So far, the above is Circuit #1 + 40.7 ft (14,3 m) added to the main line as if it was farther out where Circuit #2 is located.
- for 39.2 gpm (8,89 m<sup>3</sup>/h or 2,47 L/s) through a PVB-125, 1-1/4 in (32 mm) backflow unit \_\_\_\_\_ +

- for 39.2 gpm (8,89 m<sup>3</sup>/h or 2,47 L/s) through a 1-1/2 in (40 mm) water meter \_\_\_\_\_ +
  - estimate for fittings loss: 10% of all pipe losses \_\_\_\_\_ +
  - any losses in pressure due to elevation rise \_\_\_\_\_ +
- Subtotal \_\_\_\_\_
- any pressure gains from elevation drop \_\_\_\_\_ +
- Total pressure required by the system \_\_\_\_\_ +
- Static pressure available to the site 75 psi (5,17 bar) +
- Total pressure required by the system 75 psi (5,17 bar) +
- If this is a positive number, the system will work \_\_\_\_\_

In looking at the residential plan we have also been following, we can see the designer had a high pressure situation to deal with. With 111 psi (7,7 bar) at the meter and sprinklers requiring between 15 and 20 psi (1,03 and 1,38 bar) to operate, there was “pressure to burn.” Rather than specifying very small pipe sizes that could cause high velocity and/or surge pressure problems, the designer called for a main line pressure regulator. This component can be set for a specific downstream pressure in the main line. This reduces the amount of pipe on the project that is subjected to high pressure and provides for a beginning pressure that is closer to the sprinklers’ performance range.

In addition, the electric valves selected for the project have their own individual lateral pressure regulators. For the low application or drip watering circuits, these are fixed-outlet pressure regulators. As for the sprinkler circuits, they are the adjustable type. In this way, the designer has put complete pressure control into the system.

Before we go on, there is one quick way for sizing pipe that is often used by designers. Instead of referring again and again to a pipe chart, the designer can build a chart for flow ranges. To do this, take the pipe chart for the lateral pipe and make a quick note of the top flow for each size of pipe before it enters the shaded area on the chart. The resulting chart for Class 200 PVC pipe would look like this:

## ***Sizing Pipe and Valves and Calculating System Pressure Requirements***

<b>Size</b>	<b>Flow limit</b>
1/2 in (15 mm)	6 gpm (1,36 m <sup>3</sup> /h or 0,38 L/s)
3/4 in (20 mm)	10 gpm (2,27 m <sup>3</sup> /h or 0,63 L/s)
1 in (25 mm)	16 gpm (3,36 m <sup>3</sup> /h or 1,01 L/s)
1-1/4 in (32 mm)	26 gpm (5,90 m <sup>3</sup> /h or 1,64 L/s) and so on

The designer made up such a matrix for the residential plan we have been following. This expedited the designer's sizing of all the pipe on the project. Let's move on to the next section.

***Locating the Controller  
and Sizing Valve and  
Power Wires***

**8**

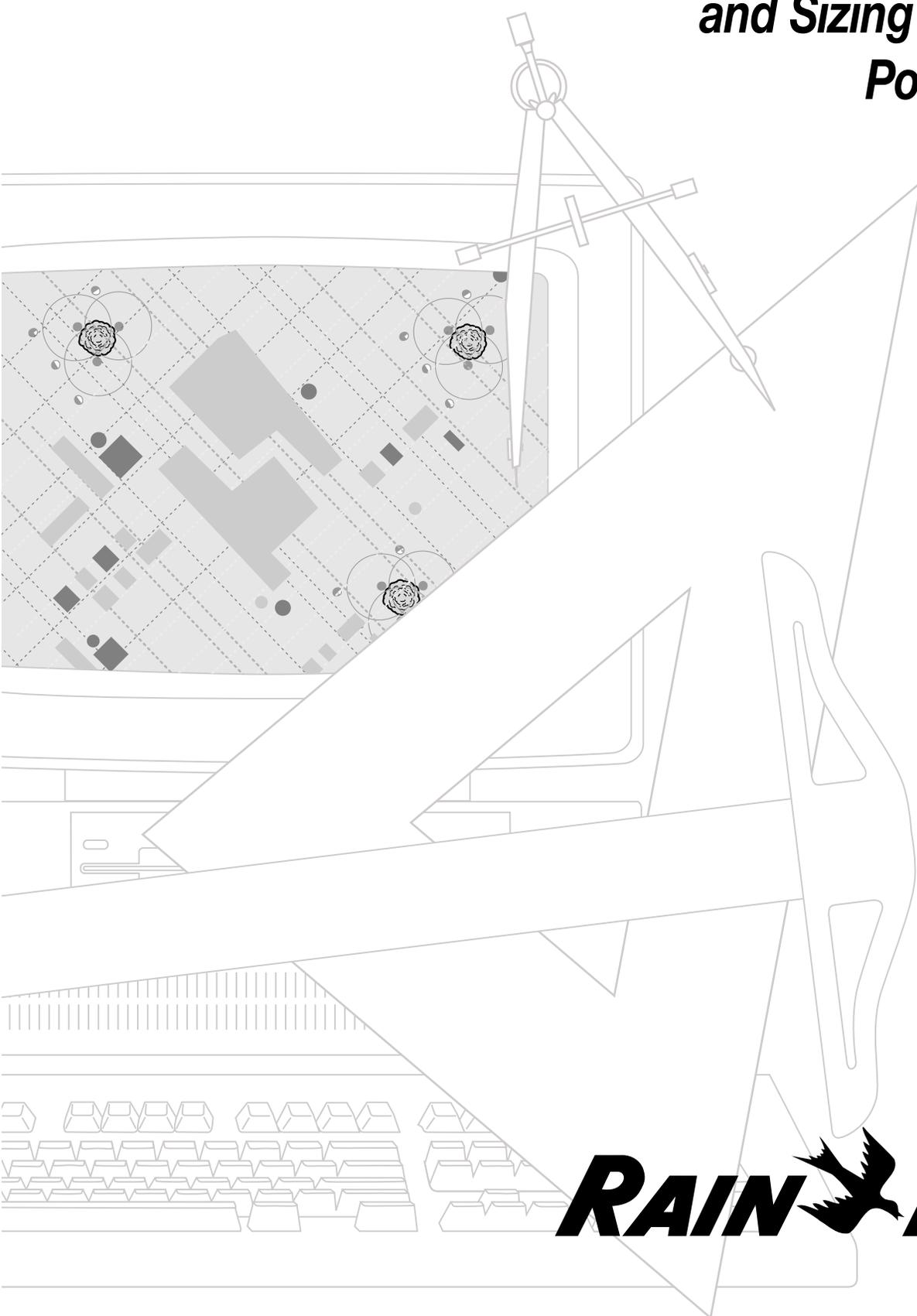

***RAIN***  ***BIRD***®



**Step eight: Locating the controller and sizing the valve and power wires**

Now that all the pipe and components for the project have been sized and a complete hydraulic analysis has proven that the system will work, it's time to turn our attention to the electrical portion of the design starting with the location of the controller.

**Locating the controller**

On large projects, where several controllers are located in various areas across the site, the controller locations are selected using a few key factors. First, to minimize the lengths of field wires to the automatic valves, the controller serving those valves should be centrally located near or within the valve group. Secondly, the controllers, where convenient, should be located in pairs or groups to minimize the length of power supply lines on the project.\*

The designer should also keep in mind the convenience of the system for the installing contractor, the maintenance crew and the system owner. Where possible, place the controller where the sprinklers operated by the unit are visible from that location. This facilitates system operational tests during installation, and later, during normal maintenance.

Controllers designed for outdoor mounting do have weather-resistant cabinets. However, when the cabinet door is open this protection is greatly reduced. So, place your controllers on the site where the sprinklers they control will not douse the cabinet. This not only protects the electronics in the controller, it also keeps the user dry during manually initiated controller operations.

**Sizing valve wires**

On our sample residential plan, the electrical power, a standard 117 volts AC (or 230 volts AC), is available in the garage where the designer has indicated the controller should be installed. The actual position for the controller within the garage is left up to the installing contractor, who will decide where to mount the unit for the best connection to the power and most convenient hookup for the field wires to the valves.

Between the controller and the electric solenoid valves that feed the sprinklers there is a network of valve control wires. Each valve is hooked up to the controller with two wires, its own individual power or control wire and the "common" or "ground" wire. The common wire is connected to, and shared by, all the valves and completes the circuit back to the controller.

\*Controllers must not share either the valve common or the MV/PS circuit. To do so is a violation of the uniform electric code and will cause controller operation problems.

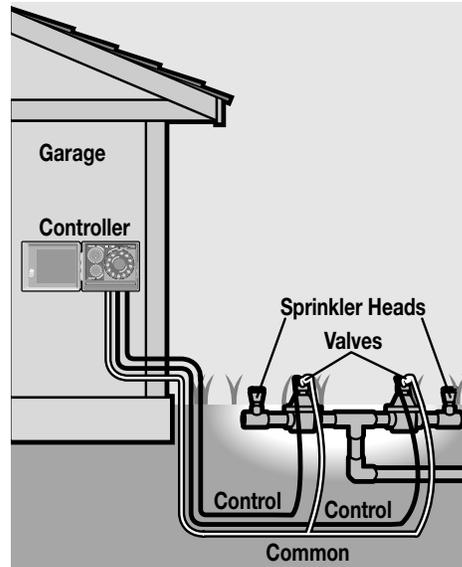

Figure 73: Valve control wire network

These wires carry a low voltage current, usually 24 volts AC, to energize the solenoid on the valve. A solenoid is simply a coil of copper wire that, when energized, lifts a plunger to open a control port in the valve. When the control port opens, it allows water pressure above the diaphragm in the valve's upper portion, or bonnet, to bleed off down stream. This pressure, which was holding back the main line water and pressure, when reduced allows the valve to open and operate the sprinklers.

The higher the pressure at the valve, the more power it takes to raise the plunger against that pressure. Therefore, when sizing the valve control wires, the static pressure at the valve is an important factor. We will see in a moment how the various pressures require their own wire sizing charts.

The wire sizing procedure for Rain Bird 24-volt solenoid valves is simple and fast, especially if the designer is specifying one valve per station on the controller. One word of caution here is that this procedure was designed for Rain Bird solenoid valves. Rain Bird manufactures its own 24-volt solenoids and they are a highly efficient, low power consuming variety. The wire sizing procedure about to be presented is for this type of valve. For less efficient, 24-volt valves that require higher amperage, this procedure may not size the wires large enough. Electrically efficient valves mean smaller, less costly, wires that can run greater distances on an irrigation project.

The four-step procedure for sizing valve control wires has some similarities with the procedure for sizing pipe. We use the "worst case" valve circuit for sizing our first pair of

## Locating the Controller and Sizing Valve and Power Wires

wires. Electrically, the “worst case” valve circuit is the one requiring the heaviest current load. Later in the procedure, we will show you how to determine which is the “worst case” circuit.

The “worst case” valve circuit will require the largest pair of wires. Because one of those wires is the “common,” when we size the wire pair for the “worst case” circuit, we have sized the common wire for all the other valves.

We will use the diagram below as a sample system for sizing field valve wires. For simplicity, the controller has only two stations. Station #1 has one valve with a 2,000 ft (600 m) run of wire to connect it to the controller. Station #2 has two valves with a 2,000 ft (600 m) wire run to the first valve and another 1,000 ft (300 m) of wire to the second valve. The water pressure is 150 psi (10,3 bar).

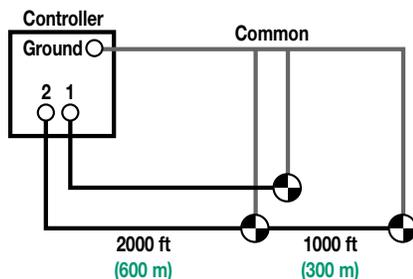

Figure 74: Sizing field valve wires

**1. Determine the actual wire run distance in feet (meters) from the controller to the first valve on a circuit and between each of the other valves on a multiple valve circuit.** Complete this for each valve circuit (station) on the controller. In our diagram, step number one is complete. All the wire lengths have been measured. This is fairly easy to accomplish using a map measure and an accurate, scaled, drawing of the site.

**2. Calculate the “equivalent circuit length” for each valve circuit.** The equivalent circuit length is calculated by multiplying the actual wire run distance to the valve by the number of valves at that location on the circuit. Station #1 in our example has only one valve on the circuit and a wire run of 2,000 ft (600 m). Its equivalent circuit length is calculated like this:

### Station #1 equivalent circuit length

$$2,000 \text{ ft} \times 1 \text{ valve} = 2,000 \text{ ft}$$

$$(600 \text{ m} \times 1 \text{ valve} = 600 \text{ m})$$

Station #2, however, is calculated with a slight variation because of its multiple valve situation. Working backward as we did for sizing pipe in a valve circuit, we start with the

1,000 ft (300 m) of wire to the last valve. The equivalent circuit length for this section is:

$$1,000 \text{ ft} \times 1 \text{ valve} = 1,000 \text{ ft}$$

$$(300 \text{ m} \times 1 \text{ valve} = 300 \text{ m})$$

The wire run of 2,000 ft (600 m) from the controller to the first valve of Station #2 provides the electricity for both valves. This section of the circuit is calculated like this:

$$2,000 \text{ ft} \times 2 \text{ valves} = 4,000 \text{ ft}$$

$$(600 \text{ m} \times 2 \text{ valves} = 1200 \text{ m})$$

Adding these two figures together we have:

$$1,000 \text{ ft} \quad (300 \text{ m})$$

$$+ 4,000 \text{ ft} \quad (+1200 \text{ m})$$

---

Station #2 has a 5,000 ft (1500 m) equivalent circuit length.

**3. From the Rain Bird wire sizing chart, select the common and control wire sizes for the circuit with the highest equivalent circuit length (the “worst case” circuit).** Use the sizing chart that most nearly approximates the static pressure in your system.

On this “worst case” circuit, the wires should be the same size or no more than one size apart. In our sample system, the pressure was 150 psi (10,3 bar). So we can use that wire chart. Though we would ideally like to use the same size wires in the pair that supports this “worst case” circuit, the charts may give us two different sizes for this pair. As the rule states, these wires have to be within one size of each other. When the wires are not the same size, the larger one is to be used as the common for the system. In wire gauge sizes, the higher the gauge number, the smaller the wire. #20 gauge wire is much smaller than #12 gauge wire.

Circuit #2 in our sample system has the highest equivalent circuit length which is 5,000 ft (1500 m). Looking at the 150 psi (10,3 bar) chart, we want to find a circuit length that is at least 5,000 ft (1500 m) and is closest to the upper left corner of the chart. This should give us the smallest acceptable wire pair.

For our 5,000 ft (1500 m) circuit length, 6,200 (1889,76) is the first number greater than or equal to 5,000 (1500). Reading across to the left-hand column we see this corresponds to a #14 (2,5 mm<sup>2</sup>) ground or common wire. Reading up to the top of the chart, we find that a #14 (2,5 mm<sup>2</sup>) control wire is sufficient also. The wires for the “worst case” circuit have been sized.



## 8 Locating the Controller and Sizing Valve and Power Wires

**RAIN BIRD 24 V AC SOLENOID VALVES WIRE SIZING CHART**  
Equivalent circuit length (in feet)  
Rain Bird 5.5 VA solenoid electric valves with 26.5 V transformers

Common wire size	80 psi water pressure at valve control wire size							
	18	16	14	12	10	8	6	4
18	3000	3700	4300	4800	5200	5500	5200	5800
16	3700	4800	5900	6900	7700	8300	8800	9100
14	4300	5900	7700	9400	11000	12300	13300	14000
12	4800	6900	9400	12200	15000	17500	19600	21100
10	5200	7700	11000	15000	19400	23900	27800	31100
8	5500	8300	12300	17500	23900	30900	38000	44300
6	5700	8800	13300	19600	27800	38000	49200	60400
4	5800	9100	14000	21100	31100	44300	60400	78200

Common wire size	100 psi water pressure at valve control wire size							
	18	16	14	12	10	8	6	4
18	2800	3500	4100	4500	4900	5200	5400	5500
16	3500	4500	5500	6500	7300	7800	8300	8500
14	4100	5500	7200	8900	10300	11600	12500	13200
12	4500	6500	8900	11500	14100	16500	18400	19900
10	4900	7300	10300	14100	18300	22500	26200	29300
8	5200	7800	11600	16500	22500	29100	35700	41700
6	5400	8300	12500	18400	26200	35700	46300	56900
4	5500	8500	13200	19900	29300	41700	56900	73600

Common wire size	125 psi water pressure at valve control wire size							
	18	16	14	12	10	8	6	4
18	2600	3200	3800	4200	4600	4800	5000	5100
16	3200	4200	5200	6000	6700	7300	7700	7900
14	3800	5200	6700	8200	9600	10800	11600	12200
12	4200	6000	8200	10700	13100	15300	17100	18500
10	4600	6700	9600	13100	17000	20900	24400	27300
8	4800	7300	10800	15300	20900	27100	33200	38800
6	5000	7700	11600	17100	24400	33200	43100	52900
4	5100	7900	12200	18500	27300	38800	52900	68500

Common wire size	150 psi water pressure at valve control wire size							
	18	16	14	12	10	8	6	4
18	2400	3000	3500	3900	4300	4500	4600	4700
16	3000	3900	4800	5600	6300	6800	7200	7400
14	3500	4800	6200	7700	9000	10000	10800	11400
12	3900	5600	7700	10000	12200	14300	16000	17300
10	4300	6300	9000	12200	15900	19500	22800	25400
8	4500	6800	10000	14300	19500	25300	31000	36200
6	4600	7200	10800	16000	22800	31000	40200	49400
4	4700	7400	11400	17300	25400	36200	49400	63900

Figure 75a: Wire sizing for 24 VAC solenoid valves (U.S. Standard Units)

**RAIN BIRD 24 V AC SOLENOID VALVES WIRE SIZING CHART**  
Equivalent circuit length (in meters)  
Rain Bird 5.5 VA solenoid electric valves with 26.5 V transformers

Common wire size	5,5 bar water pressure at valve control wire size								
	0,75	1,5	2,5	4,0	6,0	10,0	16,0	25,0	
0,75	914,40	1127,76	1310,64	1463,04	1584,96	1676,40	1584,96	1767,84	
1,5	1127,76	1463,04	1798,32	2103,12	2346,96	2529,84	2682,24	2773,68	
2,5	1310,64	1798,32	2346,96	2865,12	3352,80	3749,04	4053,84	4267,20	
4,0	1463,04	2103,12	2865,12	3718,56	4572,00	5334,00	5974,08	6431,28	
6,0	1584,96	2346,96	3352,80	4572,00	5913,12	7284,72	8473,44	9479,28	
10,0	1676,40	2529,84	3749,04	5334,00	7284,72	9418,32	11582,40	13502,64	
16,0	1737,36	2682,24	4053,84	5974,08	8473,44	11582,40	14996,16	18409,92	
25,0	1767,84	2773,68	4267,20	6431,28	9479,28	13502,64	18409,92	23835,36	

Common wire size	6,9 bar water pressure at valve control wire size								
	0,75	1,5	2,5	4,0	6,0	10,0	16,0	25,0	
0,75	853,44	1066,80	1249,68	1371,60	1493,52	1584,96	1645,92	1676,40	
1,5	1066,80	1371,60	1676,40	1981,20	2225,04	2377,44	2529,84	2590,80	
2,5	1249,68	1676,40	2194,56	2712,72	3139,44	3535,68	3810,00	4023,36	
4,0	1371,60	1981,20	2712,72	3505,20	4297,68	5029,20	5608,32	6065,52	
6,0	1493,52	2225,04	3139,44	4297,68	5577,84	6858,00	7985,76	8930,64	
10,0	1584,96	2377,44	3535,68	5029,20	6858,00	8869,68	10881,36	12710,16	
16,0	1645,92	2529,84	3810,00	5608,32	7985,76	10881,36	14112,24	17343,12	
25,0	1676,40	2590,80	4023,36	6065,52	8930,64	12710,16	17343,12	22433,28	

Common wire size	8,6 bar water pressure at valve control wire size								
	0,75	1,5	2,5	4,0	6,0	10,0	16,0	25,0	
0,75	792,48	975,36	1158,24	1280,16	1402,08	1463,04	1524,00	1554,48	
1,5	975,36	1280,16	1584,96	1828,80	2042,16	2225,04	2346,96	2407,92	
2,5	1158,24	1584,96	2042,16	2499,36	2926,08	3291,84	3535,68	3718,56	
4,0	1280,16	1828,80	2499,36	3261,36	3992,88	4663,44	5212,08	5638,80	
6,0	1402,08	2042,16	2926,08	3992,88	5212,08	6370,32	7437,12	8321,04	
10,0	1463,04	2225,04	3291,84	4663,44	6370,32	8260,08	10119,36	11826,24	
16,0	1524,00	2346,96	3535,68	5212,08	7437,12	10119,36	13136,88	16123,92	
25,0	1554,48	2407,92	3718,56	5638,90	8321,04	11826,24	16123,92	20878,80	

Common wire size	10,3 bar water pressure at valve control wire size								
	0,75	1,5	2,5	4,0	6,0	10,0	16,0	25,0	
0,75	731,52	914,40	1066,80	1188,72	1310,64	1371,60	1402,08	1432,56	
1,5	914,40	1188,72	1463,04	1706,88	1920,24	2072,64	2194,56	2255,52	
2,5	1066,80	1463,04	1889,76	2346,96	2743,20	3048,00	3291,84	3474,72	
4,0	1188,72	1706,88	2346,96	3048,00	3718,56	4358,64	4876,80	5273,04	
6,0	1310,64	1920,24	2743,20	3718,56	4846,32	5943,60	6949,44	7741,92	
10,0	1371,60	2072,64	3048,00	4358,64	5943,60	7711,44	9448,80	11033,76	
16,0	1402,08	2194,56	3291,84	4876,80	6949,44	9448,80	12252,96	15057,12	
25,0	1432,56	2255,52	3474,72	5273,04	7741,92	11033,76	15057,12	19476,72	

Figure 75b: Wire sizing for 24 VAC solenoid valves (International System Units)

## Locating the Controller and Sizing Valve and Power Wires

We could not use the 5,600 ft (1706,08 m) circuit-length number on the chart because that would have given us a #12 (4,0 mm<sup>2</sup>) common and a #16 (1,5 mm<sup>2</sup>) control wire pair which is more than one size apart. This “equal or only one size apart” restriction applies only for the “worst case” wire pair.

**4. Having the common wire size established, use the wire sizing chart to determine the control wire size for each of the remaining valve circuits on the controller.** For Station #1 with its equivalent circuit length of 2,000 ft (600 m), we read across from the #14 (2,5 mm<sup>2</sup>) gauge ground wire on the 150 psi (10,3 bar) chart to the first number equal to or greater than 2,000 ft (600 m). The 3,500 (1066,80) in the first column satisfies this requirement, and when we read up to the top of the chart we see that a #18 (0,75 mm<sup>2</sup>) control wire will work for this circuit. If there were more stations being used on the controller, we would complete this step by sizing all the other valve circuit control wires.

The wire designed for use on automatic irrigation systems is known as **U.F.** or “underground feeder” wire. These are single, copper conductor, thickly insulated, low-voltage wires that are direct-buried without the need for electrical conduit. Always check the local electrical or building codes for the type of wire to use on your project.

On larger commercial projects, U.F. wire sizes smaller than #14 (2,5 mm<sup>2</sup>) are seldom used. Even though the smaller wires can handle the load electrically (according to the sizing chart), they lack physical strength. As the wires get smaller, the combination of smaller conductors and thick insulation can hide wire breaks. When the installer is spooling off wires from several reels on the back of a truck, a smaller size conductor can break while its thick insulation remains intact. The result is a wire fault that will have to be discovered and fixed.

The other electrical wires that need to be sized for the project are the controller power wires. The variable factors that dictate what size wire to use for supplying power to the controller are:

- available voltage at the power source
- distance from the power source to the controllers
- minimum voltage required to operate the controller
- power required by the type of valve used
- the number of valves used on any one station of the controller
- the number of controllers operating at one time

As irrigation projects get bigger, with more controllers, sizing the 120 (230) volt supply wires to their minimum can become quite complicated. To simplify the process, you can use the five-step procedure outlined below with the charts which include information on the power requirements for Rain Bird automatic controllers and valves.

Let’s do one example so that you will become familiar with this procedure. The diagram below illustrates the situation: a 3,000 ft (900 m) wire run with two controllers at different locations, and two solenoid valves per station on at least one station of each controller.

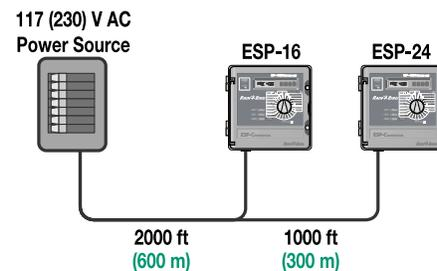

Figure 76: Two controllers with wire runs at different locations

### Sizing power wires

The following is the 120 (230) V AC primary wire sizing procedure for Rain Bird controllers and valves.

**1. Using figure 77, determine the power requirements for the controller you have selected, as well as the requirements for the number of solenoid valves that will be operating at one time.** (You may have only one valve per station. However, if you are using a master valve to shut down the project’s main line between irrigation cycles, this would raise the requirement to two valves.)

#### Example

Controller primary current requirements from Figure 77:

An ESP controller alone	=	.03 amps
Two solenoid valves .12 x 2	=	.24 amps +
<hr/>		
Primary requirements for an ESP controller and 2 valves	=	.27 amps

**2. Determine the maximum allowable voltage drop along the wires from the power source to the controllers.** To do this you find the voltage available at the power source and subtract from it the voltage required at the controller. The result is how much can be lost. It’s like sizing pipe to determine pressure loss.

**CONTROLLERS AND VALVES FOR POWER WIRE SIZING**

Electrical current requirements

Type of controller or valve	117 (230) volt primary current requirements in amps
<b>Controllers only</b>	<b>With power on not in a cycle</b>
RC-Bi	0.13
RC-C	0.13
RC-AB	0.26
ESP	0.03
ESP-Si	0.06
ESP-LXi+	0.06
ESP-LX+	0.13
ESP-MC	0.15
<b>Valves only</b>	<b>Current draw when energized</b>
Solenoid valve	0.12

Figure 77: Electrical current requirements of controllers and valves

**Example**

Maximum allowable voltage drop:

$$\begin{aligned}
 \text{Power available at the source} &= 120 \text{ V AC (230 V AC)} \\
 \text{ISC power requirement stated in catalog} &= 117 \text{ V AC (220 V AC)} - \\
 \text{Maximum allowable voltage drop} &= 3 \text{ V AC (10 V AC)}
 \end{aligned}$$

**ESP Series Dual Program Hybrid Controllers electrical characteristics:**

- Input required: 117 (220) V AC ± 10%, 60 (50) Hz
- Output: 24 to 26.5 V AC, 1.5 A
- Circuit breaker: 1.5 A
- UL listed and tested
- Sequential operation: When more than one station is programmed to start at the same time, those stations will water in sequence starting from the station with the lowest number

**3. Calculate the equivalent circuit length for the power wire and controller or controllers.** You will see how similar this is to the way we calculated equivalent circuit lengths for valve wires.

**Example**

Calculate the equivalent circuit length working backwards (farthest out) from the controller:

$$\begin{aligned}
 1 \text{ controller x } 1000 \text{ ft (300 m)} &= 1000 \text{ ft (300 m)} \\
 2 \text{ controllers x } 2000 \text{ ft (600 m)} &= 4000 \text{ ft (1200 m)} + \\
 \text{Total equivalent circuit length} &= 5000 \text{ ft (1500 m)}
 \end{aligned}$$

**4. Using the formula, calculate the F factor for the circuit.**

**Example**

To calculate the circuit's F factor, the formula is:

$$F = \frac{\text{allowable voltage drop}}{\text{amps/control unit x equivalent length in thousands of feet (meters)}}$$

$$F = \frac{3 \text{ V}}{.17 \text{ A x } 5} = 3.529 \text{ or } 3.53 \quad \left( F = \frac{3 \text{ V}}{.17 \text{ A x } 1524} = .012 \right)$$

**5. Select a power wire size from Figure 78 that has an F factor equal to or less than the calculated F factor.** Think of the F factor as friction loss in a pipe. We want to select a wire with an F factor for loss that is equal to or less than the loss or "F" factor for the circuit.

Wire size	"F" factor
#18 (,75 mm <sup>2</sup> )	13.02 (,043)
#16 (1,5 mm <sup>2</sup> )	8.18 (,027)
#14 (2,5 mm <sup>2</sup> )	5.16 (,017)
#12 (4,0 mm <sup>2</sup> )	3.24 (,011)
#10 (6,0 mm <sup>2</sup> )	2.04 (,007)
#8 (10,0 mm <sup>2</sup> )	1.28 (,004)
#6 (16,0 mm <sup>2</sup> )	0.81 (,003)
#4 (25,0 mm <sup>2</sup> )	0.51 (,002)

Figure 78: Wires size and F factor

**Example:**

Select a power wire from Figure 78 that has an F factor equal to or less than the 3.53 (0,012) we have calculated. Number 12 (4,0 mm<sup>2</sup>) wire has an F factor of 3.24 (0,011) which is the factor immediately less than our calculated 3.53 (0,012). Our supply wires for the controllers would be size #12 (4,0 mm<sup>2</sup>).

With all of the hydraulic and electrical calculations complete, the designer is ready for the last step in the process.



# Preparing the Final Irrigation Plan

9

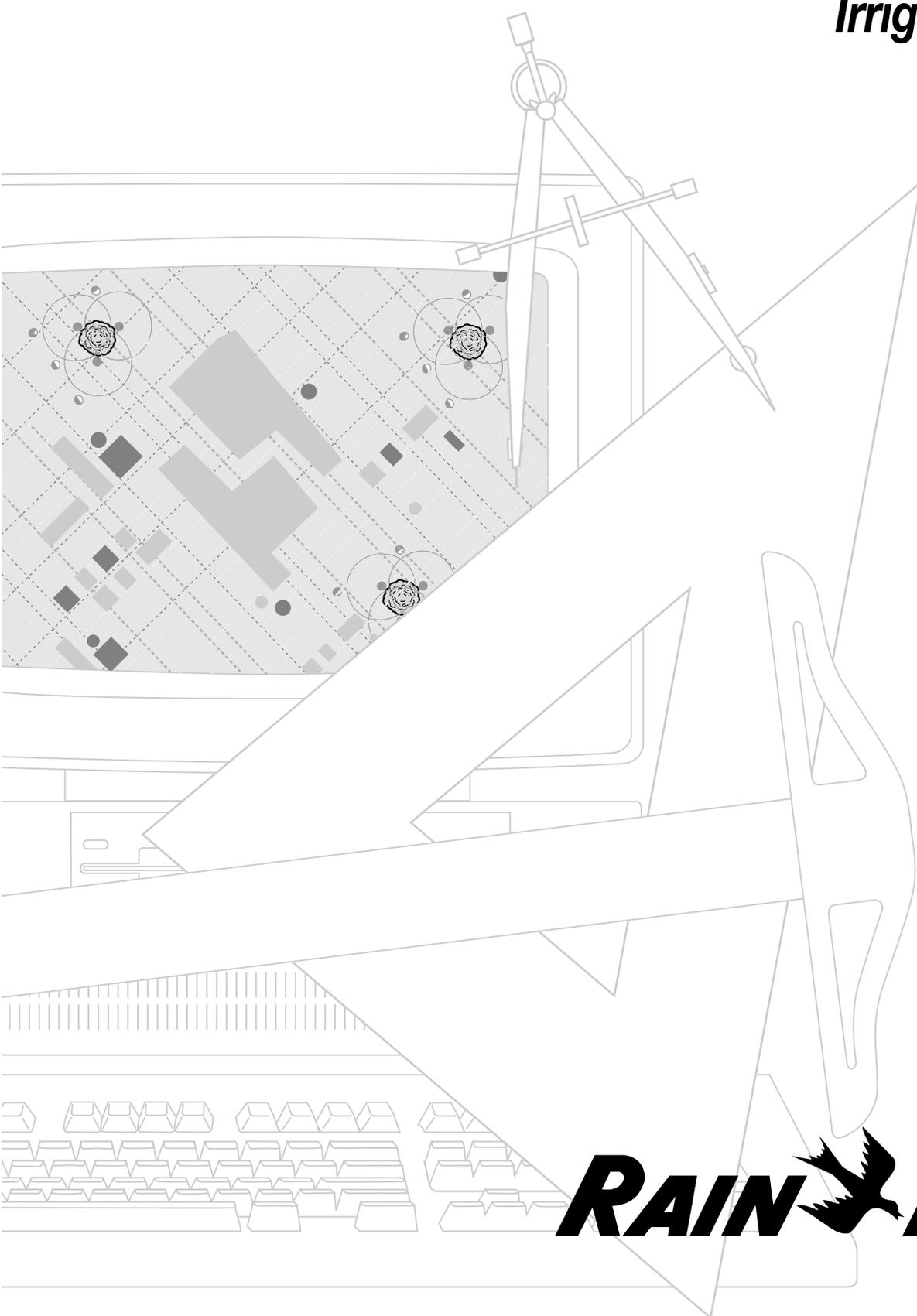

**RAIN  BIRD**<sup>®</sup>  
RAIN  BIRD



## Step nine: Preparing the final irrigation plan

The last step in the irrigation system design procedure is preparing the final irrigation plan. The final irrigation plan is a diagram representing what the sprinkler system should look like after installation. Because the installing contractor will follow the plan as the system goes in, the plan should be as thorough as possible. After reviewing the drawings, the contractor should have very few questions about the designer's intent.

Detailed plans for commercial installations usually have installation drawings that show exactly how each type of product is to be installed. These drawings are often available as line drawings on transparent sheets so they can be shot with the blueprint of the project design.

Other points you should keep in mind when preparing the final plan are:

- The plan should be readable, usable and drawn at a convenient scale.
- The plan should have a detailed legend explaining all the symbols used in the drawing.
- The plan should show any major elevation changes.
- The plan should show all water and power utility locations, not just those to which the contractor will need to hook up. Buried telephone cables, power lines or water mains can be very expensive to have repaired, and the contractor must know their location to avoid cutting into them.

- The plan should contain special notes for any specific requirements which must be met. Local codes and ordinances, system programming instructions, installation criteria, and rules affecting the landscape from a homeowners' association could all be part of the special instructions.

When the final irrigation plan is complete and the designer presents it to the client, all the designer's decisions and intentions should be clearly discernible so that the system can go in as designed.

Now that you have had some exposure to the procedures for sizing the electrical portion of an irrigation system and what goes into the final plan, you have seen the last of the material to be covered in this manual. Turn to page 85 and do the last set of exercises. The answers are in the Solutions section on page 92.

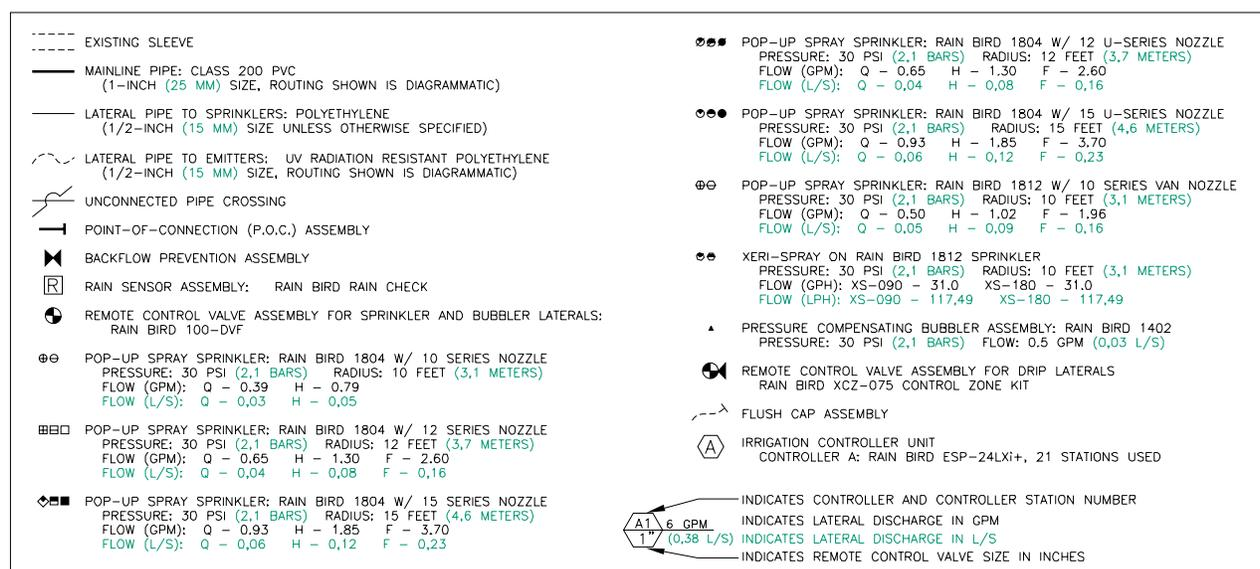

Figure 79: Irrigation legend

Preparing the Final Irrigation Plan

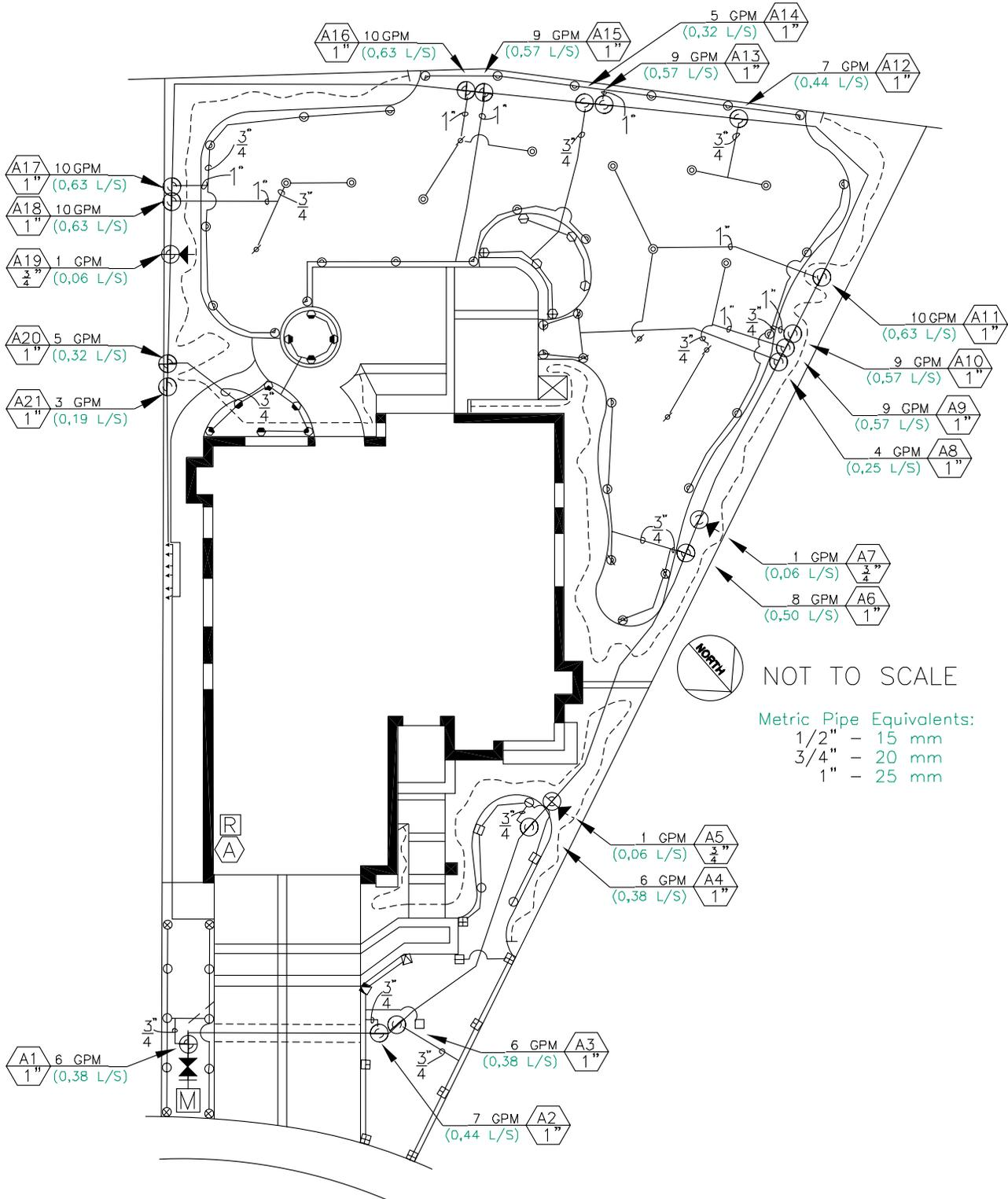
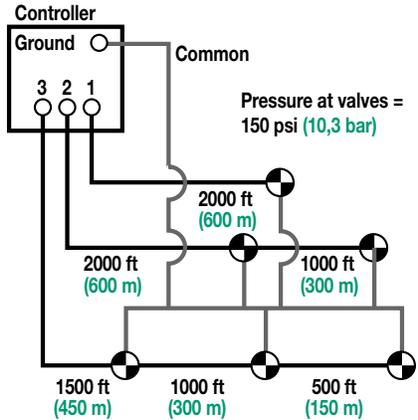

Figure 80: Final irrigation plan

**Exercises on system electrics and preparing the final irrigation plan**

The electrical system diagrammed below may look somewhat familiar to you. It's the system we looked at earlier. This time, however, there is a third station on the controller. Station #3 is now the "worst case" electrical circuit on the controller. Follow the procedure for sizing valve wires as you fill in the blanks.



Step one is complete on this diagram. The actual distances from controller to valve and any subsequent valves per circuit have been determined for you.

A. To complete step number two, calculate the equivalent circuit length for station #3.

Station #3:

one valve x \_\_\_\_\_ = \_\_\_\_\_  
 two valves x \_\_\_\_\_ = \_\_\_\_\_  
 three valves x \_\_\_\_\_ = \_\_\_\_\_

Total equivalent circuit length of \_\_\_\_\_

B. According to the rule on sizing the wires for the "worst case" circuit, the common and control wires must be the \_\_\_\_\_ size or within \_\_\_\_\_ size of each other.

C. For Station #3's equivalent circuit length, what is the acceptable common or ground wire size according to the wire sizing chart?

Number \_\_\_\_\_ wire

D. What control wire size is required?

Number \_\_\_\_\_ wire

E. With the new ground wire size established, what size control wire matches up with it to provide power for Station #2?

Number \_\_\_\_\_ wire

F. Fill in the blanks for controller power wire sizing using the diagram below. Each controller has at least one station with two valves.

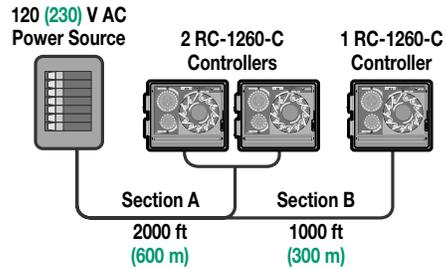

1. The primary current in amps for the RC-1260-C controller is \_\_\_\_\_?
2. The energy draw for a Rain Bird solenoid valve is \_\_\_\_\_ amps.
3. What is the total draw for each control unit when operating its valves?

RC-1260-C = \_\_\_\_\_ amps  
 Two solenoid valves = \_\_\_\_\_ amps  
 Total draw = \_\_\_\_\_ amps

4. The allowable voltage drop if the RC-1260-C operates at 117 (220)V AC is \_\_\_\_\_ volts.
5. The equivalent circuit length for the power wires on this system is:

\_\_\_\_\_ feet for section "B"  
 \_\_\_\_\_ feet for section "A"  
 \_\_\_\_\_ total feet for the system

Calculate the "F" factor for the circuit.

     V = an F factor of       
 ? A x ?

6. From Figure 78, the wire size with an F factor equal to or immediately less the calculated F factor is # \_\_\_\_\_ wire.
7. On the final irrigation plan, the \_\_\_\_\_ should list and identify all the symbols used in the drawing.
8. The final plan should be drawn to a convenient, readable \_\_\_\_\_.
9. \_\_\_\_\_ drawings included with the plan show how each major component is to be hooked up.
10. Underground \_\_\_\_\_ should be noted on the plan to avoid cutting into them during installation of the system.

## ***Preparing the Final Irrigation Plan***

**Congratulations!** You have completed this program. You are armed and dangerous, so to speak! You have studied the theory, but have yet to practice it on an actual project design. We suggest that you try designing a system as soon as possible, enlisting the assistance of an experienced designer on your first effort. In this way, you will better retain what you have learned.

### **Irrigation references**

A list of professional irrigation consultants may be obtained from the American Society of Irrigation Consultants, PO Box 426, Bryon, California 94514 USA. ASIC's telephone number is 925-516-1124 and their Web page can be found at [www.asic.org](http://www.asic.org).

If you would like additional reading, we offer the following books for reference:

Bliesner, Ron D., and Jack Keller. *Sprinkle and Trickle Irrigation*. New York: Van Nostrand Reinhold, 1990.

Sarsfield, A.C., et al. *The ABCs of Lawn Sprinkler Systems*. California: Irrigation Technical Services, 1996.

Keesen, Larry. *The Complete Irrigation Workbook: Design, Installation, Maintenance, and Water Management*. Ohio: Franzak & Foster, 1995.

Melby, Pete. *Simplified Irrigation Design*. Second Edition. New York: Van Nostrand Reinhold, 1995.

Pair, Claude H., et al. *Irrigation*. Fifth Edition. Virginia: The Irrigation Association, 1983.

Rochester, Eugene W. *Landscape Irrigation Design*. Michigan: The American Society of Agricultural Engineers, 1995.

Smith, Stephen W. *Landscape Irrigation Design and Management*. New York: John Wiley & Sons, Inc., 1997.

United States Golf Association. *Wastewater Reuse for Golf Course Irrigation*. Michigan: Lewis Publishers, 1994.

Walker, Rodger. *Pump Selection: A Consulting Engineers Manual*. Michigan: Ann Arbor Science Publishers, Inc., 1972.

# Solutions

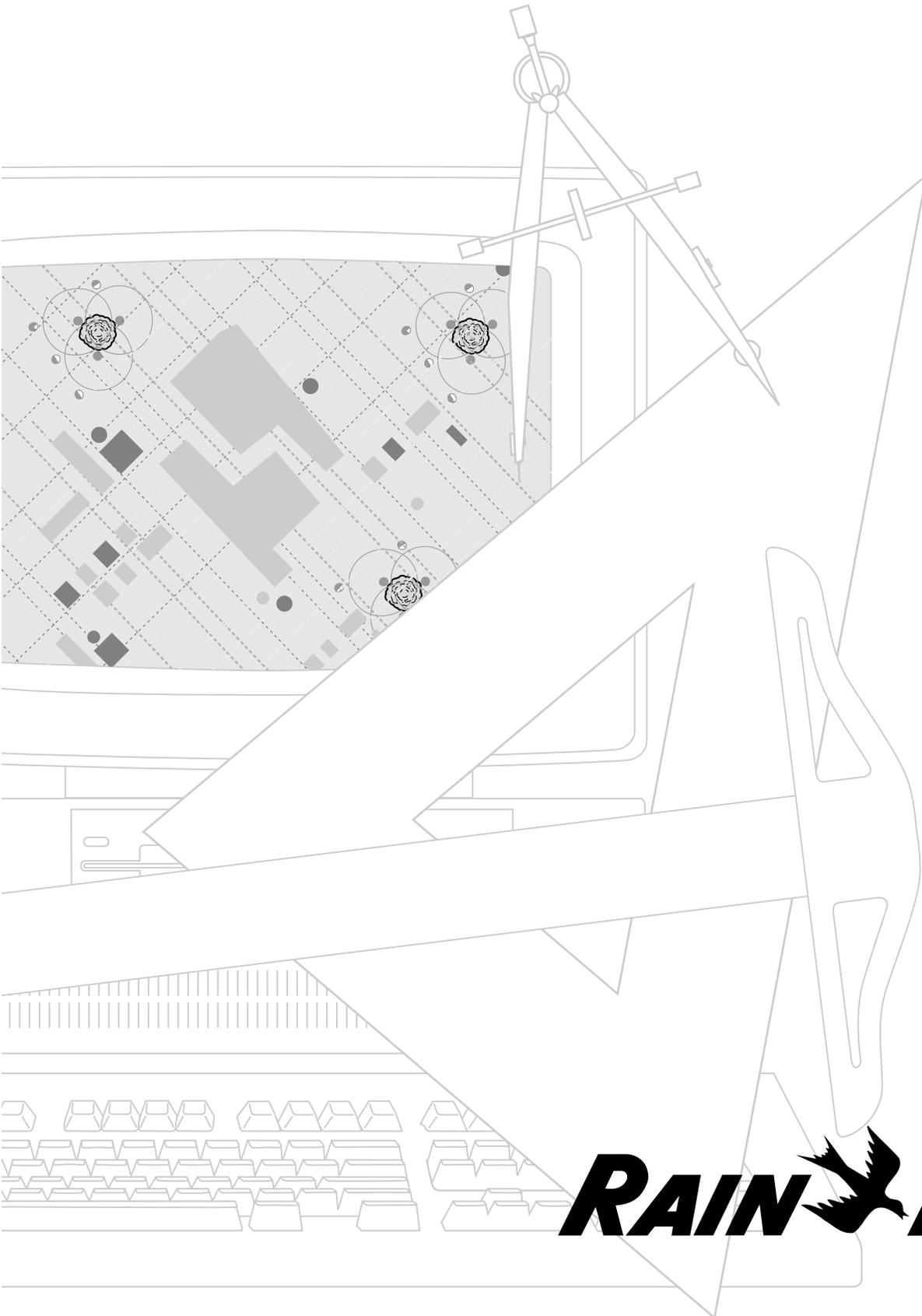

**RAIN  BIRD®**



**Solutions to exercises on basic hydraulics**

- A.** To find the static water pressure in psi at point B, multiply  $.433 \times 160 = 69.28$  psi (To find the static water pressure in bar at point B, divide 50 by 10 =5 bar).
- B.** No difference.
- C.** Point D = 90.93 psi (6,5 bar)  
Point E = 123.405 psi (8,8 bar)
- D.** Point B had a static pressure of 69.28 psi (5 bar). After you subtract the friction loss caused by the above flow through 100 ft (30 m) of 1-1/4 in (32 mm) Class 200 PVC pipe, the dynamic pressure at B is 66.82 psi (4,8 bar).

Point C dynamic pressure		
= 64.85 psi (4,7 bar) .....	+ 64.85	(4,7)
Friction loss through		
50 ft of pipe (15 m) .....	- 1.23	(0,1)
Elevation pressure gain		
of 50 ft (15 m) .....	+ 21.65	(1,5)
Point D dynamic pressure		
= 85.27 psi (6,1 bar) .....	+ 85.27	(6,1)
Friction loss through		
100 ft (30 m) of pipe .....	- 2.46	(0,2)
Elevation pressure gain		
of 75 ft (23 m) .....	+ 32.47	(2,3)
Point E dynamic pressure		
= 115.28 psi (8,2 bar) .....	+115.28	(8,2)

The valve at point E can supply 26 gpm (5,9 m<sup>3</sup>/h or 1,64 L/s) at 115.28 psi (8,2 bar) water pressure.

- E.** If the last 100 ft (30 m) of pipe went up 75 ft (23 m) from point D to point E, instead of down, the 32.47 psi (2,3 bar) elevation pressure gain in the calculation would be a loss instead. The working pressure at point E would be 50.34 psi (3,6 bar).

**Solutions to exercises on site information and irrigation requirements**

- A.** Plot plan
- B.** Static
- C.** Wind direction and velocity
  - Tree locations
  - Walkways and driveways
  - All buildings
  - Location of water source
  - Area measurements
  - Walls and fences
  - Slopes

- D.** Night
- E.** Evapotranspiration
- F.** Reference evapotranspiration
- G.** Temperature and humidity
- H.** Warm, humid
- I.** .20 in (5 mm)
- J.** Clay soil
- K.** 45°

**Solutions to exercises on water capacity and pressure**

- A.** Rule 1: The pressure loss through the water meter should not exceed 10% of the minimum static water pressure available in the city main.  
Rule 2: The maximum flow through the meter for irrigation should not exceed 75% of the maximum safe flow of the meter.  
Rule 3: The velocity of flow through the service line should not exceed 5 to 7-1/2 ft/s (1,5 to 2,3 m/s).
- B.** 111 psi (7,7 bar)
- C.** 4 psi (0,8 bar); .24 psi (0,05 bar)
- D.** 2 ft (0,61 m) of straight 1-1/4 (32 mm) in tubing; .08 psi (0,01 bar)
- E.** 12 psi (0,03 bar)
- F.** .433 psi (0,1 bar); 1.299 or 1.3 psi (0,3 bar); a loss
- G.** .08 psi (0,01 bar); .12 psi (0,03 bar)
- H.** .03 psi (0,002 bar)
- I.** 5.8 psi (0,40 bar)
- J.** .11 psi (0,008 bar)
- K.** Point of connection (POC)
- L.** Static pressure in the main is..... + 111.00 psi (7,70 bar)  
Loss through component #1 is ..... - .24 psi (0,05 bar)  
Loss through component #2 is ..... - .08 psi (0,01 bar)  
Loss through component #3 is ..... - .12 psi (0,03 bar)  
Elevation loss is ..... - 1.30 psi (0,30 bar)  
Loss through component #4 is ..... - .08 psi (0,01 bar)  
Loss through component #5 is ..... - .12 psi (0,03 bar)  
Loss through component #6 is .... - .03 psi (0,002 bar)

## Solutions

Loss through component #7 is .... – 5.80 psi (0,40 bar)

Loss through component #8 is .... – .11 psi (0,008 bar)

The remaining pressure at #9 is... 103.12 psi (6,86 bar)

Until we had determined the pressure available at the point of connection for this irrigation system, which is 103.12 psi (6,86 bar) and the flow limit of 19 gpm (4,31 m<sup>3</sup>/h or 1,20 L/s), we could not properly select the sprinklers to use. If we saw only that there was 111 psi (7,7 bar) static pressure in the city main, we could create severe hydraulic problems by simply designing in a bunch of sprinklers to use up the available pressure. Particularly in a high pressure situation, the tendency of those unfamiliar with basic hydraulics is to let the pressure force the water flow to its greatest potential. This would seem to be the way to get the most out of the system by running large numbers of sprinklers at one time. However, this could cause pipes to burst from surge pressures or destroy the water meter.

### Solutions to exercises on selecting sprinklers

#### A. Area size

Area shape

Water pressure

Wind conditions

Types of plants

Flows available

Slope on site

#### B. Rotor pop-up

#### C. Impact sprinklers on risers

#### D. Pop-up spray sprinklers

#### E. Spray sprinklers generally have fixed arc patterns

Rotor pop-ups usually have adjustable arcs

For large radius coverage, an impact sprinkler would be a better choice than a spray sprinkler

An emitter is a drip irrigation device

#### F. The radius of coverage for a sprinkler

The model numbers for the equipment

The flow requirement for sprinklers

The pressure requirement for sprinklers

The arc pattern for a sprinkler

### Solutions to exercises on spacing sprinklers and calculating precipitation rates

#### A. Head-to-head spacing only 60% of the sprinkler's diameter of throw

#### B. Rectangular pattern

#### C. Square pattern

#### D. Only the flow entering the pattern we're checking

#### E. Is a constant

#### F. Sprinkler spacing and row spacing

Distance between sprinklers on a line and between that line and the next

"S" is spacing between sprinklers, "L" is for spacing between rows of sprinklers on their laterals

$$G. \frac{96.3 \times 5 \text{ gpm}}{45 \text{ ft} \times 45 \text{ ft}} = .237 \text{ or } .238 \quad \left( \frac{1000 \times 2 \text{ m}^3/\text{h} = 8,89 \text{ or } 9}{15 \text{ m} \times 15 \text{ m}} \right)$$

#### H. Inches (millimeter); hour

#### I. Four; parallelogram

The height of the sprinkler pattern can be determined by multiplying 15 ft x .866 = 12.99 ft or 13 ft (5m x 0,866 = 4,33 m).

$$\frac{96.3 \times 4 \text{ gpm}}{15 \text{ ft} \times 13 \text{ ft}} = 1.97 \text{ or } 1.98 \quad \left( \frac{1000 \times .90 \text{ m}^3/\text{h} = 41,57}{5 \text{ m} \times 4,33 \text{ m}} \right)$$

### Solutions to exercises on locating sprinklers

#### A. A 12-ft (3,6-m) radius spray sprinkler

#### B. A 12-ft (3,6-m) pop-up spray sprinkler

#### D. 15 sprinklers

#### E. 6 sprinklers

#### F. Square

#### G. If a tree or large bush in the center of a lawn area can tolerate the same amount of water as the turfgrass, it is best to plot the sprinklers to surround the bush or tree to avoid blocking the sprinklers' coverage of the lawn.

#### H. A bubbler

An emitter

#### I. Impact sprinkler

**Solutions to exercises on circuit configuration and operating time**

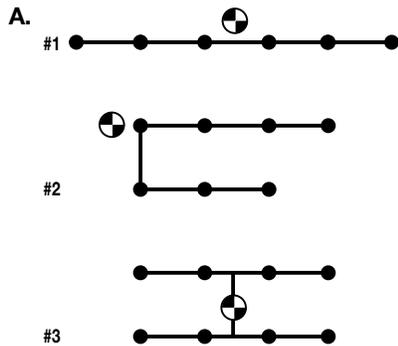

**B.**  $\frac{2 \times 60 = 60 \text{ to } 61 \text{ min/cycle}}{.33 \times 6}$   $\left( \frac{50 \times 60 = 59,5 \text{ to } 60 \text{ min/cycle}}{8,4 \times 6} \right)$

**C.** 26 to 27 (26) minutes per cycle

**D.** 90 to 91 (89) minutes per cycle

**E.**  $\frac{1.498 \times 60 = 19 \text{ to } 20 \text{ min/cycle}}{.67 \times 7}$   $\left( \frac{35 \times 60 = 17 \text{ to } 18 \text{ min/cycle}}{17 \times 7} \right)$

**F.** Adequate cover is required to protect a main line pipe from damage from overhead traffic.

**G.** True

**Solutions to exercises on calculating system pressure requirements**

Pressure needed at sprinkler = 55 psi (3,8 bar)

Pressure loss:

For 9.8 gpm (2,23 m<sup>3</sup>/h or 0,62 L/s) through 47 ft (14,3 m) of 3/4 in (20 mm) class 200 PVC pipe ..... 2.026 (0,139) +

For 19.6 gpm (4,45 m<sup>3</sup>/h or 1,24 L/s) through 47 ft (14,3 m) of 1-1/4 in (32 mm) class 200 PVC pipe ..... 709 (0,049) +

For 29.4 gpm (6,67 m<sup>3</sup>/h or 1,85 L/s) through 47 ft (14,3 m) of 1-1/2 in (40 mm) class 200 PVC pipe ..... 780 (0,054) +

For 39.2 gpm (8,89 m<sup>3</sup>/h or 2,47 L/s) through 23.5 ft (7,2 m) of 2 in (50 mm) class 200 PVC pipe ... 223 (0,015) +

For 39.2 gpm (8,89 m<sup>3</sup>/h or 2,47 L/s) through a 150-PEB, 1-1/2 in electric valve ..... 1.900 (0,16) +

For 39.2 gpm (8,89 m<sup>3</sup>/h or 2,47 L/s) through 162.8 ft (50 m) of 2 in (50 mm) schedule 40 PVC pipe ..... 1.872 (0,130) +

So far, the above is Circuit #1 plus 40.7 ft (12,41 m) added to the main line as if it was further out where circuit #2 is located.

For 39.2 gpm (8,89 m<sup>3</sup>/h or 2,47 L/s) through a PVB-125, 1-1/4 in (32 mm) backflow unit ..... 3.800 (0,262) +

For 39.2 gpm (8,89 m<sup>3</sup>/h or 2,47 L/s) through a 1-1/2 in (40 mm) water meter ..... 3.300 (0,228) +

Estimate for fittings loss:

10% of all pipe losses: ..... .561 (0,039) +

Any losses in pressure due to elevation rise: ..... 0.000 (0,000) +

*Subtotal* ..... 70.17 (4,876)

Pressure gains from elevation drop ..... 0.000 (0,000) -

Total pressure required by system .. 70.17 (4,876)

Static pressure available to site ..... 75 (5,17)

Total pressure required by system ..... 70.17 (4,876) -

If this is a positive number the system will work ..... 4.83 (0,294)

As you can see after working through this analysis, the system will work. After deducting all the losses and the pressure required at that last “worst case” sprinkler, the system was still about 5 psi (0,3 bar) to the good.

**Solutions to exercises on system electric and preparing the final irrigation plan**

**A.** Station #3:

One valve x 500 ft (150 m) = 500 (150 m)  
Two valves x 1000 ft (300 m) = 2000 (600 m)  
Three valves x 1500 ft (450 m) = 4500 (1350 m)  
Total equivalent circuit length = 7000 ft (2100 m)

**B.** According to the rule on sizing the wires for the “worst case” circuit, the common and control wires must be the same size or within one size of each other.

## Solutions

- C. Number 12 (4,0 mm<sup>2</sup>) wire
- D. Number 14 (2,5 mm<sup>2</sup>) wire
- E. Number 16 (1,5 mm<sup>2</sup>) wire
- F. 1. The primary current in amps for the RC-1260-C controller is .13.
2. The energy draw for a Rain Bird solenoid valve is .07 amps.
3. RC-1260-C = .13 amps  
Two solenoid valves = .14 amps  
Total draw = .27 amps
4. The allowable voltage drop if the RC-1260-C operates at 117 (220) VAC is 3 (10) volts.
5. The equivalent circuit length for the power wires on this system is:
- 1 controller x 1000 ft (300 m) = 1000 ft (300 m) for section "B"
- 3 controllers x 2000 ft (600 m) = 6000 ft (1800 m) for section "A"
- 7,000 total ft (2100 m) for the system
- Calculate the F factor for the circuit.
- $$\frac{3 \text{ V}}{.27 \text{ A} \times 7} = 1.58 \text{ F factor} \quad \left( \frac{3 \text{ V}}{.27 \text{ A} \times 2133,6} = ,005 \text{ F factor} \right)$$
6. Number 8 (10 mm<sup>2</sup>) wire.
7. On the final irrigation plan, the legend should list and identify all the symbols used in the drawing.
8. The final plan should be drawn to a convenient, readable scale.
9. Installation drawings included with the plan show how each major component is to be hooked up.
10. Underground utilities should be noted on the plan to avoid cutting into them during installation of the system.

**Technical  
Data**

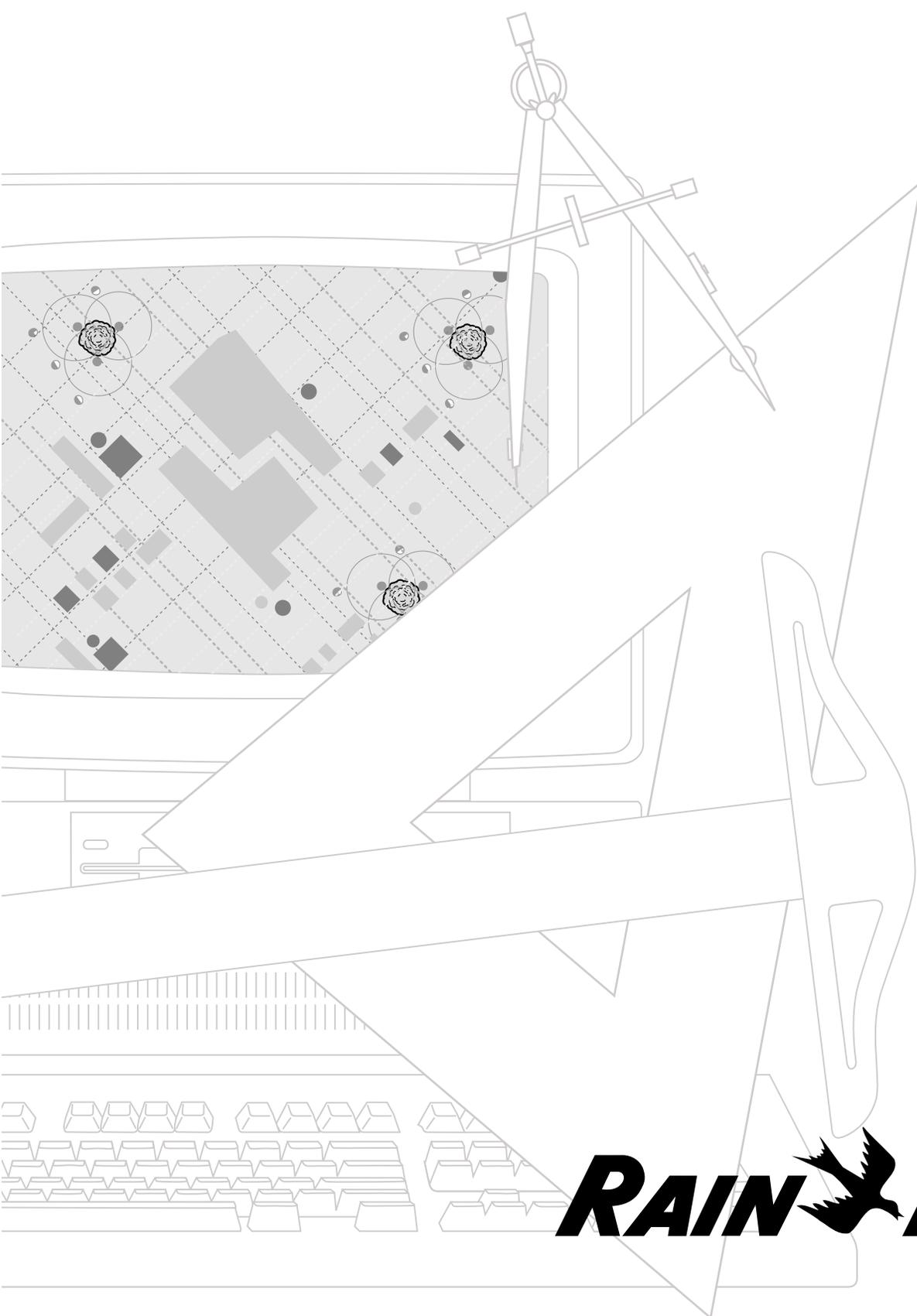

**RAIN  BIRD<sup>®</sup>**

Technical Data

Friction loss characteristics PVC schedule 80 IPS plastic pipe

# PVC SCHEDULE 80 IPS PLASTIC PIPE

(1120, 1220) C=150  
 PSI loss per 100 feet of pipe (psi/100 ft)

**PVC CLASS 80 IPS PLASTIC PIPE**  
 Sizes 1/2 in through 6 in. Flow 1 through 600 gpm.

SIZE	1/2 in	3/4 in	1 in	1 1/4 in	1 1/2 in	2 in	2 1/2 in	3 in	4 in	6 in
OD	0.840	1.050	1.315	1.660	1.900	2.375	2.875	3.500	4.500	6.625
ID	0.546	0.742	0.957	1.278	1.500	1.939	2.323	2.900	3.826	5.761
Wall Thk	0.147	0.154	0.179	0.191	0.200	0.218	0.276	0.300	0.337	0.432

flow gpm	velocity fps	psi loss	velocity fps	psi loss	velocity fps	psi loss	velocity fps	psi loss	velocity fps	psi loss	velocity fps	psi loss	velocity fps	psi loss	velocity fps	psi loss	velocity fps	psi loss	velocity fps	psi loss
1	1.36	0.81	0.74	0.18	0.44	0.05	0.24	0.01	0.18	0.01	0.10	0.00								
2	2.73	2.92	1.48	0.66	0.89	0.19	0.49	0.05	0.36	0.02	0.21	0.01	0.15	0.00						
3	4.10	6.19	2.22	1.39	1.33	0.40	0.74	0.10	0.54	0.05	0.32	0.01	0.22	0.01						
4	5.47	10.54	2.96	2.37	1.78	0.69	0.99	0.17	0.72	0.08	0.43	0.02	0.30	0.01						
5	6.84	15.93	3.70	3.58	2.22	1.04	1.24	0.25	0.90	0.12	0.54	0.03	0.37	0.01	0.24	0.00				
6	8.21	22.33	4.44	5.02	2.67	1.46	1.49	0.36	1.08	0.16	0.65	0.05	0.45	0.02	0.29	0.01				
7	9.58	29.71	5.18	6.68	3.11	1.94	1.74	0.47	1.26	0.22	0.75	0.06	0.52	0.03	0.33	0.01				
8	10.94	38.05	5.92	8.56	3.56	2.48	1.99	0.61	1.45	0.28	0.86	0.08	0.60	0.03	0.38	0.01				
9	12.31	47.33	6.66	10.64	4.00	3.09	2.24	0.76	1.63	0.35	0.97	0.10	0.68	0.04	0.43	0.01				
10	13.68	57.52	7.41	12.93	4.45	3.75	2.49	0.92	1.81	0.42	1.08	0.12	0.75	0.05	0.48	0.02	0.27	0.00		
11	15.05	68.63	8.15	15.43	4.90	4.47	2.74	1.10	1.99	0.50	1.19	0.14	0.83	0.06	0.53	0.02	0.30	0.01		
12	16.42	80.63	8.89	18.13	5.34	5.26	2.99	1.29	2.17	0.59	1.30	0.17	0.90	0.07	0.58	0.02	0.33	0.01		
14			10.37	24.12	6.23	6.99	3.49	1.71	2.53	0.79	1.51	0.23	1.05	0.09	0.67	0.03	0.39	0.01		
16			11.85	30.88	7.12	8.95	3.99	2.19	2.90	1.01	1.73	0.29	1.20	0.12	0.77	0.04	0.44	0.01		
18			13.33	38.41	8.01	11.14	4.49	2.73	3.26	1.26	1.95	0.36	1.36	0.15	0.87	0.05	0.50	0.01		
20			14.82	46.69	8.90	13.54	4.99	3.31	3.62	1.52	2.17	0.44	1.51	0.18	0.97	0.06	0.55	0.02		
22			16.30	55.70	9.80	16.15	5.49	3.95	3.98	1.81	2.38	0.52	1.66	0.22	1.06	0.07	0.61	0.02		
24			17.78	65.44	10.69	18.97	5.99	4.64	4.35	2.13	2.60	0.61	1.81	0.25	1.16	0.09	0.66	0.02		
26			19.26	75.90	11.58	22.01	6.49	5.39	4.71	2.47	2.82	0.71	1.96	0.29	1.26	0.10	0.72	0.03		
28					12.47	25.24	6.99	6.18	5.07	2.83	3.03	0.81	2.11	0.34	1.35	0.11	0.78	0.03		
30					13.36	28.69	7.49	7.02	5.43	3.22	3.25	0.92	2.26	0.38	1.45	0.13	0.83	0.03	0.36	0.00
35					15.59	38.16	8.74	9.34	6.34	4.29	3.79	1.23	2.64	0.51	1.69	0.17	0.97	0.05	0.43	0.01
40					17.81	48.87	9.99	11.96	7.25	5.49	4.34	1.57	3.02	0.65	1.94	0.22	1.11	0.06	0.49	0.01
45							11.24	14.88	8.16	6.83	4.88	1.96	3.40	0.81	2.18	0.28	1.25	0.07	0.55	0.01
50							12.49	18.09	9.06	8.30	5.42	2.38	3.78	0.99	2.42	0.34	1.39	0.09	0.61	0.01
55							13.73	21.58	9.97	9.90	5.96	2.84	4.15	1.18	2.66	0.40	1.53	0.10	0.67	0.01
60							14.98	25.35	10.87	11.63	6.51	3.33	4.53	1.38	2.91	0.47	1.67	0.12	0.73	0.02
65							16.23	29.40	11.78	13.49	7.05	3.87	4.91	1.61	3.15	0.55	1.81	0.14	0.79	0.02
70							17.48	33.72	12.69	15.47	7.59	4.44	5.29	1.84	3.39	0.63	1.95	0.16	0.86	0.02
75							18.73	38.32	13.59	17.58	8.13	5.04	5.67	2.09	3.63	0.71	2.09	0.18	0.92	0.03
80							19.98	43.19	14.50	19.81	8.68	5.68	6.04	2.36	3.88	0.80	2.22	0.21	0.98	0.03
85									15.41	22.16	9.22	6.36	6.42	2.63	4.12	0.90	2.36	0.23	1.04	0.03
90									16.32	24.64	9.76	7.07	6.80	2.93	4.36	1.00	2.50	0.26	1.10	0.04
95									17.22	27.23	10.30	7.81	7.18	3.24	4.60	1.10	2.64	0.29	1.16	0.04
100									18.13	29.95	10.85	8.59	7.56	3.57	4.85	1.21	2.78	0.31	1.22	0.04
110									19.94	35.73	11.93	10.25	8.31	4.25	5.33	1.45	3.06	0.38	1.35	0.05
120											13.02	12.04	9.07	5.00	5.82	1.70	3.34	0.44	1.47	0.06
130											14.10	13.96	9.82	5.60	6.30	1.97	3.62	0.51	1.59	0.07
140											15.19	16.02	10.58	6.65	6.79	2.27	3.90	0.59	1.72	0.08
150											16.27	18.20	11.34	7.56	7.27	2.57	4.18	0.67	1.84	0.09
160											17.36	20.51	12.09	8.51	7.76	2.89	4.45	0.75	1.96	0.10
170											18.44	22.95	12.85	9.53	8.24	3.24	4.73	0.84	2.08	0.11
180											19.53	25.51	13.60	10.59	8.73	3.60	5.01	0.93	2.21	0.13
190													14.36	11.71	9.21	3.98	5.29	1.03	2.33	0.14
200													15.12	12.87	9.70	4.37	5.57	1.14	2.45	0.16
225													17.01	16.01	10.91	5.44	6.27	1.41	2.76	0.19
250													18.90	19.46	12.12	6.61	6.96	1.72	3.07	0.23
275															13.34	7.89	7.66	2.05	3.38	0.28
300															14.55	9.27	8.36	2.41	3.68	0.33
325															15.76	10.75	9.05	2.79	3.99	0.38
350															16.97	12.33	9.75	3.20	4.30	0.44
375															18.19	14.01	10.45	3.64	4.60	0.50
400															19.40	15.79	11.14	4.10	4.91	0.56
425																	11.84	4.59	5.22	0.63
450																	12.54	5.10	5.53	0.70
475																	13.23	5.64	5.83	0.77
500																	13.93	6.20	6.14	0.85
550																	15.32	7.40	6.76	1.01
600																	16.72	8.69	7.37	1.19

Note: Outlined area of chart indicates velocities over 5 ft/s. Use with caution.

Velocity of flow values are computed from the general equation  $V = .408 \frac{Q}{d^2}$

Friction pressure loss values are computed from the equation:

$$hf = 0.2083 \left( \frac{100}{C} \right)^{1.852} \frac{Q^{1.852}}{d^{4.866}} \times .433 \text{ for psi loss per 100 ft of pipe}$$

Technical Data  
 U.S. Standard Units



Friction loss characteristics PVC schedule 40 IPS plastic pipe

# PVC SCHEDULE 40 IPS PLASTIC PIPE

(1120, 1220) C=150

PSI loss per 100 feet of pipe (psi/100 ft)

**PVC CLASS 40 IPS PLASTIC PIPE**

Sizes 1/2 in through 6 in. Flow 1 through 600 gpm.

SIZE	1/2 in	3/4 in	1 in	1 1/4 in	1 1/2 in	2 in	2 1/2 in	3 in	4 in	6 in
OD	0.840	1.050	1.315	1.660	1.900	2.375	2.875	3.500	4.500	6.625
ID	0.622	0.824	1.049	1.380	1.610	2.067	2.469	3.068	4.026	6.065
Wall Thk	0.109	0.113	0.133	0.140	0.145	0.154	0.203	0.216	0.237	0.280

flow gpm	velocity fps	psi loss	velocity fps	psi loss	velocity fps	psi loss	velocity fps	psi loss	velocity fps	psi loss	velocity fps	psi loss	velocity fps	psi loss	velocity fps	psi loss	velocity fps	psi loss	velocity fps	psi loss
1	1.05	0.43	0.60	0.11	0.37	0.03	0.21	0.01	0.15	0.00										
2	2.11	1.55	1.20	0.39	0.74	0.12	0.42	0.03	0.31	0.02	0.19	0.00								
3	3.16	3.28	1.80	0.84	1.11	0.26	0.64	0.07	0.47	0.03	0.28	0.01	0.20	0.00						
4	4.22	5.60	2.40	1.42	1.48	0.44	0.85	0.12	0.62	0.05	0.38	0.02	0.26	0.01						
5	5.27	8.46	3.00	2.15	1.85	0.66	1.07	0.18	0.78	0.08	0.47	0.02	0.33	0.01	0.21	0.00				
6	6.33	11.86	3.60	3.02	2.22	0.93	1.28	0.25	0.94	0.12	0.57	0.03	0.40	0.01	0.26	0.01				
7	7.38	15.77	4.20	4.01	2.59	1.24	1.49	0.33	1.10	0.15	0.66	0.05	0.46	0.02	0.30	0.01				
8	8.44	20.20	4.80	5.14	2.96	1.59	1.71	0.42	1.25	0.20	0.76	0.06	0.53	0.02	0.34	0.01				
9	9.49	25.12	5.40	6.39	3.33	1.97	1.92	0.52	1.41	0.25	0.85	0.07	0.60	0.03	0.39	0.01				
10	10.55	30.54	6.00	7.77	3.70	2.40	2.14	0.63	1.57	0.30	0.95	0.09	0.66	0.04	0.43	0.01				
11	11.60	36.43	6.60	9.27	4.07	2.86	2.35	0.75	1.73	0.36	1.05	0.11	0.73	0.04	0.47	0.02				
12	12.65	42.80	7.21	10.89	4.44	3.36	2.57	0.89	1.88	0.42	1.14	0.12	0.80	0.05	0.52	0.02	0.30	0.00		
14	14.76	56.94	8.41	14.48	5.19	4.47	2.99	1.18	2.20	0.56	1.33	0.17	0.93	0.07	0.60	0.02	0.35	0.01		
16	16.87	72.92	9.61	18.55	5.93	5.73	3.42	1.51	2.51	0.71	1.52	0.21	1.07	0.09	0.69	0.03	0.40	0.01		
18	18.98	90.69	10.81	23.07	6.67	7.13	3.85	1.88	2.83	0.89	1.71	0.26	1.20	0.11	0.78	0.04	0.45	0.01		
20	21.09	110.23	12.01	28.04	7.41	8.66	4.28	2.28	3.14	1.08	1.90	0.32	1.33	0.13	0.86	0.05	0.50	0.01		
22			13.21	33.45	8.15	10.33	4.71	2.72	3.46	1.29	2.10	0.38	1.47	0.16	0.95	0.06	0.55	0.01		
24			14.42	39.30	8.89	12.14	5.14	3.20	3.77	1.51	2.29	0.45	1.60	0.19	1.04	0.07	0.60	0.02		
26			15.62	45.58	9.64	14.08	5.57	3.17	4.09	1.75	2.48	0.52	1.74	0.22	1.12	0.08	0.65	0.02		
28			16.82	52.28	10.38	16.15	5.99	4.25	4.40	2.01	2.67	0.60	1.87	0.25	1.21	0.09	0.70	0.02		
30			18.02	59.41	11.12	18.35	6.42	4.83	4.72	2.28	2.86	0.68	2.00	0.29	1.30	0.10	0.75	0.03		
35					12.97	24.42	7.49	6.43	5.50	3.04	3.34	0.90	2.34	0.38	1.51	0.13	0.88	0.04	0.38	0.00
40					14.83	31.27	8.56	8.23	6.29	3.89	3.81	1.15	2.67	0.49	1.73	0.17	1.00	0.04	0.44	0.01
45					16.68	38.89	9.64	10.24	7.08	4.84	4.29	1.43	3.01	0.60	1.95	0.21	1.13	0.06	0.49	0.01
50					18.53	47.27	10.71	12.45	7.87	5.88	4.77	1.74	3.34	0.73	2.16	0.26	1.25	0.07	0.55	0.01
55							11.78	14.85	8.65	7.01	5.25	2.08	3.68	0.88	2.38	0.30	1.38	0.08	0.61	0.01
60							12.85	17.45	9.44	8.24	5.72	2.44	4.01	1.03	2.60	0.36	1.51	0.10	0.66	0.01
65							13.92	20.23	10.23	9.56	6.20	2.83	4.35	1.19	2.81	0.41	1.63	0.11	0.72	0.02
70							14.99	23.21	11.01	10.96	6.68	3.25	4.68	1.37	3.03	0.48	1.76	0.13	0.77	0.02
75							16.06	26.37	11.80	12.46	7.16	3.69	5.01	1.56	3.25	0.54	1.88	0.14	0.83	0.02
80							17.13	29.72	12.59	14.04	7.63	4.16	5.35	1.75	3.46	0.61	2.01	0.16	0.88	0.02
85							18.21	33.26	13.37	15.71	8.11	4.66	5.68	1.96	3.68	0.68	2.13	0.18	0.94	0.02
90							19.28	36.97	14.16	17.46	8.59	5.18	6.02	2.18	3.90	0.76	2.26	0.20	0.99	0.03
95									14.95	19.30	9.07	5.72	6.35	2.41	4.11	0.84	2.39	0.22	1.05	0.03
100									15.74	21.22	9.54	6.29	6.69	2.65	4.33	0.92	2.51	0.25	1.10	0.03
110									17.31	25.32	10.50	7.51	7.36	3.16	4.76	1.10	2.76	0.29	1.22	0.04
120									18.88	29.75	11.45	8.82	8.03	3.72	5.20	1.29	3.02	0.34	1.33	0.05
130											12.41	10.23	8.70	4.31	5.63	1.50	3.27	0.40	1.44	0.05
140											13.36	11.74	9.37	4.94	6.06	1.72	3.52	0.46	1.55	0.06
150											14.32	13.33	10.03	5.62	6.50	1.95	3.77	0.52	1.66	0.07
160											15.27	15.03	10.70	6.33	6.93	2.20	4.02	0.59	1.77	0.08
170											16.23	16.81	11.37	7.08	7.36	2.46	4.27	0.66	1.88	0.09
180											17.18	18.69	12.04	7.87	7.80	2.74	4.53	0.73	1.99	0.10
190											18.14	20.66	12.71	8.70	8.23	3.02	4.78	0.81	2.10	0.11
200											19.09	22.72	13.38	9.57	8.66	3.33	5.03	0.89	2.21	0.12
225													15.05	11.90	9.75	4.14	5.66	1.10	2.49	0.15
250													16.73	14.47	10.83	5.03	6.29	1.34	2.77	0.18
275													18.40	17.26	11.92	6.00	6.92	1.60	3.05	0.22
300															13.00	7.05	7.55	1.88	3.32	0.26
325															14.08	8.17	8.18	2.18	3.60	0.30
350															15.17	9.38	8.81	2.50	3.88	0.34
375															16.25	10.65	9.43	2.84	4.15	0.39
400															17.33	12.01	10.06	3.20	4.43	0.44
425															18.42	13.43	10.69	3.58	4.71	0.49
450															19.50	14.93	11.32	3.98	4.99	0.54
475																	11.95	4.40	5.26	0.60
500																	12.58	4.84	5.54	0.66
550																	13.84	5.77	6.10	0.79
600																	15.10	6.78	6.65	0.92

Note: Outlined area of chart indicates velocities over 5 ft/s. Use with caution.

Velocity of flow values are computed from the general equation  $V = .408 \frac{Q}{d^2}$

Friction pressure loss values are computed from the equation:

$$hf = 0.2083 \left( \frac{100}{C} \right)^{1.852} \frac{Q^{1.852}}{d^{4.866}} \times .433 \text{ for psi loss per 100 ft of pipe}$$



Technical Data

Friction loss characteristics PVC class 315 IPS plastic pipe

# PVC CLASS 315 IPS PLASTIC PIPE

(1120, 1220) SDR 13.5 C=150

PSI loss per 100 feet of pipe (psi/100 ft)

Technical Data  
U.S. Standard Units

**PVC CLASS 315 IPS PLASTIC PIPE**

Sizes 1/2 in through 6 in. Flow 1 through 600 gpm.

SIZE	1/2 in	3/4 in	1 in	1 1/4 in	1 1/2 in	2 in	2 1/2 in	3 in	4 in	6 in											
OD	0.840	0.050	1.315	1.660	1.900	2.375	2.875	3.500	4.500	6.625											
ID	0.716	0.894	1.121	1.414	1.618	2.023	2.449	2.982	3.834	5.643											
Wall Thk	0.062	0.078	0.097	0.123	0.141	0.176	0.213	0.259	0.333	0.491											
flow gpm	velocity fps	psi loss	velocity fps	psi loss	velocity fps	psi loss	velocity fps	psi loss	velocity fps	psi loss	velocity fps	psi loss	velocity fps	psi loss	velocity fps	psi loss	velocity fps	psi loss	velocity fps	psi loss	
1	0.79	0.22	0.51	0.07	0.32	0.02	0.20	0.01	0.15	0.00											
2	1.59	0.78	1.02	0.27	0.64	0.09	0.40	0.03	0.31	0.01	0.19	0.00									
3	2.38	1.65	1.53	0.56	0.97	0.19	0.61	0.06	0.46	0.03	0.29	0.01	0.20	0.00							
4	3.18	2.82	2.04	0.96	1.29	0.32	0.81	0.10	0.62	0.05	0.39	0.02	0.27	0.01							
5	3.97	4.26	2.55	1.45	1.62	0.48	1.02	0.16	0.77	0.08	0.49	0.03	0.34	0.01	0.22	0.00					
6	4.77	5.97	3.06	2.03	1.94	0.67	1.22	0.22	0.93	0.11	0.59	0.04	0.40	0.02	0.27	0.01					
7	5.57	7.95	3.57	2.70	2.27	0.90	1.42	0.29	1.09	0.15	0.69	0.05	0.47	0.02	0.32	0.01					
8	6.36	10.18	4.08	3.45	2.59	1.15	1.63	0.37	1.24	0.19	0.79	0.06	0.54	0.03	0.36	0.01					
9	7.16	12.66	4.59	4.30	2.92	1.43	1.83	0.46	1.40	0.24	0.89	0.08	0.61	0.03	0.41	0.01					
10	7.95	15.38	5.10	5.22	3.24	1.74	2.04	0.56	1.55	0.29	0.99	0.10	0.68	0.04	0.45	0.01	0.27	0.00			
11	8.75	18.35	5.61	6.23	3.57	2.07	2.24	0.67	1.71	0.35	1.09	0.12	0.74	0.05	0.50	0.02	0.30	0.01			
12	9.55	21.56	6.12	7.32	3.89	2.43	2.44	0.79	1.87	0.41	1.19	0.14	0.81	0.05	0.55	0.02	0.33	0.01			
14	11.14	28.69	7.14	9.74	4.54	3.24	2.85	1.05	2.18	0.54	1.39	0.18	0.95	0.07	0.64	0.03	0.38	0.01			
16	12.73	36.74	8.16	12.47	5.19	4.15	3.26	1.34	2.49	0.70	1.59	0.23	1.08	0.09	0.73	0.04	0.44	0.01			
18	14.32	45.69	9.18	15.51	5.84	5.16	3.67	1.67	2.80	0.87	1.79	0.29	1.22	0.12	0.82	0.04	0.49	0.01			
20	15.91	55.54	10.20	18.86	6.49	6.27	4.08	2.03	3.11	1.05	1.99	0.35	1.36	0.14	0.91	0.05	0.55	0.02			
22	17.50	66.26	11.23	22.50	7.14	7.48	4.48	2.42	3.42	1.25	2.19	0.42	1.49	0.17	1.00	0.06	0.61	0.02			
24	19.10	77.84	12.25	26.43	7.79	8.79	4.89	2.84	3.74	1.47	2.39	0.50	1.63	0.20	1.10	0.08	0.66	0.02			
26			13.27	30.65	8.44	10.19	5.30	3.29	4.05	1.71	2.59	0.58	1.76	0.23	1.19	0.09	0.72	0.03			
28			14.29	35.16	9.09	11.69	5.71	3.78	4.36	1.96	2.79	0.66	1.90	0.26	1.28	0.10	0.77	0.03	0.35	0.00	
30			15.31	39.95	9.74	13.29	6.12	4.29	4.67	2.23	2.99	0.75	2.04	0.30	1.37	0.11	0.83	0.03	0.38	0.01	
35			17.86	53.15	11.36	17.68	7.14	5.71	5.45	2.96	3.48	1.00	2.38	0.39	1.60	0.15	0.97	0.04	0.44	0.01	
40					12.98	22.64	8.16	7.31	6.23	3.80	3.98	1.28	2.72	0.51	1.83	0.19	1.11	0.06	0.51	0.01	
45					14.61	28.15	9.18	9.10	7.01	4.72	4.48	1.59	3.06	0.63	2.06	0.24	1.24	0.07	0.57	0.01	
50					16.23	34.22	10.20	11.06	7.79	5.74	4.98	1.94	3.40	0.76	2.29	0.29	1.38	0.09	0.64	0.01	
55					17.85	40.83	11.22	13.19	8.57	6.85	5.48	2.31	3.74	0.91	2.52	0.35	1.52	0.10	0.70	0.02	
60					19.48	47.97	12.24	15.50	9.35	8.04	5.98	2.71	4.08	1.07	2.75	0.41	1.66	0.12	0.76	0.02	
65							13.26	17.97	10.13	9.33	6.48	3.15	4.42	1.24	2.98	0.48	1.80	0.14	0.83	0.02	
70							14.28	20.62	10.90	10.70	6.97	3.61	4.76	1.42	3.21	0.55	1.94	0.16	0.89	0.02	
75							15.30	23.43	11.68	12.16	7.47	4.10	5.10	1.62	3.44	0.62	2.08	0.18	0.96	0.03	
80							16.32	26.40	12.46	13.71	7.97	4.62	5.44	1.82	3.67	0.70	2.22	0.21	1.02	0.03	
85							17.34	29.54	13.24	15.33	8.47	5.17	5.78	2.04	3.89	0.78	2.35	0.23	1.08	0.04	
90							18.36	32.84	14.02	17.05	8.97	5.75	6.12	2.27	4.12	0.87	2.49	0.26	1.15	0.04	
95							19.38	36.30	14.80	18.84	9.47	6.35	6.46	2.51	4.35	0.96	2.63	0.28	1.21	0.04	
100									15.58	20.72	9.96	6.99	6.80	2.76	4.58	1.06	2.77	0.31	1.28	0.05	
110							17.14	24.72	10.96	8.34	7.48	3.29	5.04	1.26	3.05	0.37	1.40	0.06			
120							18.70	29.04	11.96	9.79	8.16	3.87	5.50	1.48	3.33	0.44	1.53	0.07			
130									12.96	11.36	8.84	4.48	5.96	1.72	3.60	0.51	1.66	0.08			
140									13.95	13.03	9.52	5.14	6.42	1.97	3.88	0.58	1.79	0.09			
150									14.95	14.81	10.20	5.84	6.88	2.24	4.16	0.66	1.92	0.10			
160									15.95	16.69	10.88	6.59	7.34	2.53	4.44	0.74	2.04	0.11			
170									16.94	18.67	11.56	7.37	7.79	2.83	4.71	0.83	2.17	0.13			
180									17.94	20.75	12.24	8.19	8.25	3.14	4.99	0.93	2.30	0.14			
190									18.94	22.94	12.92	9.05	8.71	3.47	5.27	1.02	2.43	0.16			
200									19.93	25.23	13.60	9.95	9.17	3.82	5.55	1.12	2.56	0.17			
225													15.30	12.38	10.32	4.75	6.24	1.40	2.88	0.21	
250													17.00	15.05	11.47	5.77	6.93	1.70	3.20	0.26	
275													18.70	17.95	12.61	6.89	7.63	2.03	3.52	0.31	
300															13.76	8.09	8.32	2.38	3.84	0.36	
325															14.91	9.39	9.02	2.76	4.16	0.42	
350															16.05	10.77	9.71	3.17	4.48	0.48	
375															17.20	12.23	10.40	3.60	4.80	0.55	
400															18.35	13.79	11.10	4.06	5.12	0.62	
425															19.49	15.42	11.79	4.54	5.44	0.69	
450																12.49	5.05	5.76	0.77		
475																13.18	5.58	6.08	0.85		
500																13.87	6.14	6.40	0.94		
550																15.26	7.32	7.04	1.12		
600																16.65	8.60	7.68	1.31		

Note: Outlined area of chart indicates velocities over 5 ft/s. Use with caution.

Velocity of flow values are computed from the general equation  $V = .408 \frac{Q}{d^2}$

Friction pressure loss values are computed from the equation:

$$hf = 0.2083 \left( \frac{100}{C} \right)^{1.852} \frac{Q^{1.852}}{d^{4.866}} \times .433 \text{ for psi loss per 100 ft of pipe}$$

Friction loss characteristics PVC class 200 IPS plastic pipe

# PVC CLASS 200 IPS PLASTIC PIPE

(1120, 1220) SDR 21 C=150

PSI loss per 100 feet of pipe (psi/100 ft)

**PVC CLASS 200 IPS PLASTIC PIPE**

Sizes 3/4 in through 6 in. Flow 1 through 600 gpm.

SIZE	3/4 in	1 in	1 1/4 in	1 1/2 in	2 in	2 1/2 in	3 in	4 in	6 in
OD	1.050	1.315	1.660	1.900	2.375	2.875	3.500	4.500	6.625
ID	0.930	1.189	1.502	1.720	2.149	2.601	3.166	4.072	5.993
Wall Thk	0.060	0.063	0.079	0.090	0.113	0.137	0.167	0.214	0.316

flow gpm	velocity fps	psi loss	velocity fps	psi loss	velocity fps	psi loss	velocity fps	psi loss	velocity fps	psi loss	velocity fps	psi loss	velocity fps	psi loss	velocity fps	psi loss	velocity fps	psi loss
1	0.47	0.06	0.28	0.02	0.18	0.01	0.13	0.00										
2	0.94	0.22	0.57	0.07	0.36	0.02	0.27	0.01	0.17	0.00								
3	1.42	0.46	0.86	0.14	0.54	0.04	0.41	0.02	0.26	0.01	0.18	0.00						
4	1.89	0.79	1.15	0.24	0.72	0.08	0.55	0.04	0.35	0.01	0.24	0.01						
5	2.36	1.20	1.44	0.36	0.90	0.12	0.68	0.06	0.44	0.02	0.30	0.01						
6	2.83	1.68	1.73	0.51	1.08	0.16	0.82	0.08	0.53	0.03	0.36	0.01	0.24	0.00				
7	3.30	2.23	2.02	0.67	1.26	0.22	0.96	0.11	0.61	0.04	0.42	0.01	0.28	0.01				
8	3.77	2.85	2.30	0.86	1.44	0.28	1.10	0.14	0.70	0.05	0.48	0.02	0.32	0.01				
9	4.25	3.55	2.59	1.07	1.62	0.34	1.24	0.18	0.79	0.06	0.54	0.02	0.36	0.01				
10	4.72	4.31	2.88	1.30	1.80	0.42	1.37	0.22	0.88	0.07	0.60	0.03	0.40	0.01				
11	5.19	5.15	3.17	1.56	1.98	0.50	1.51	0.26	0.97	0.09	0.66	0.03	0.44	0.01				
12	5.66	6.05	3.46	1.83	2.17	0.59	1.65	0.30	1.06	0.10	0.72	0.04	0.48	0.02	0.29	0.00		
14	6.60	8.05	4.04	2.43	2.53	0.78	1.93	0.40	1.23	0.14	0.84	0.05	0.56	0.02	0.34	0.01		
16	7.55	10.30	4.61	3.11	2.89	1.00	2.20	0.52	1.41	0.17	0.96	0.07	0.65	0.03	0.39	0.01		
18	8.49	12.81	5.19	3.87	3.25	1.24	2.48	0.64	1.59	0.22	1.08	0.09	0.73	0.03	0.44	0.01		
20	9.43	15.58	5.77	4.71	3.61	1.51	2.75	0.78	1.76	0.26	1.20	0.10	0.81	0.04	0.49	0.01		
22	10.38	18.58	6.34	5.62	3.97	1.80	3.03	0.93	1.94	0.32	1.32	0.12	0.89	0.05	0.54	0.01		
24	11.32	21.83	6.92	6.60	4.34	2.12	3.30	1.09	2.12	0.37	1.44	0.15	0.97	0.06	0.59	0.02		
26	12.27	25.32	7.50	7.65	4.70	2.46	3.58	1.27	2.29	0.43	1.56	0.17	1.05	0.07	0.63	0.02		
28	13.21	29.04	8.08	8.78	5.06	2.82	3.86	1.46	2.47	0.49	1.68	0.19	1.13	0.07	0.68	0.02		
30	14.15	33.00	8.65	9.98	5.42	3.20	4.13	1.66	2.65	0.56	1.80	0.22	1.22	0.09	0.73	0.02	0.34	0.00
35	16.51	43.91	10.10	13.27	6.32	4.26	4.82	2.20	3.09	0.75	2.11	0.29	1.42	0.11	0.86	0.03	0.39	0.01
40	18.87	56.23	11.54	17.00	7.23	5.45	5.51	2.82	3.53	0.95	2.41	0.38	1.62	0.14	0.98	0.04	0.45	0.01
45			12.98	21.14	8.13	6.78	6.20	3.51	3.97	1.19	2.71	0.47	1.83	0.18	1.10	0.05	0.51	0.01
50			14.42	25.70	9.04	8.24	6.89	4.26	4.41	1.44	3.01	0.57	2.03	0.22	1.23	0.06	0.56	0.01
55			15.87	30.66	9.94	9.83	7.58	5.09	4.85	1.72	3.31	0.68	2.23	0.26	1.35	0.08	0.62	0.01
60			17.31	36.02	10.85	11.55	8.27	5.97	5.30	2.02	3.61	0.80	2.44	0.31	1.47	0.09	0.68	0.01
65			18.75	41.77	11.75	13.40	8.96	6.93	5.74	2.35	3.92	0.93	2.64	0.36	1.59	0.10	0.73	0.02
70					12.65	15.37	9.65	7.95	6.18	2.69	4.22	1.06	2.84	0.41	1.72	0.12	0.79	0.02
75					13.56	17.47	10.34	9.03	6.62	3.06	4.52	1.21	3.05	0.46	1.84	0.14	0.85	0.02
80					14.46	19.68	11.03	10.18	7.06	3.44	4.82	1.36	3.25	0.52	1.96	0.15	0.90	0.02
85					15.37	22.02	11.72	11.39	7.50	3.85	5.12	1.52	3.45	0.59	2.09	0.17	0.96	0.03
90					16.27	24.48	12.41	12.66	7.95	4.28	5.42	1.69	3.66	0.65	2.21	0.19	1.02	0.03
95					17.18	27.06	13.10	13.99	8.39	4.74	5.72	1.87	3.86	0.72	2.33	0.21	1.07	0.03
100					18.08	29.76	13.79	15.39	8.83	5.21	6.03	2.06	4.07	0.79	2.46	0.23	1.13	0.04
110					19.89	35.50	15.17	18.36	9.71	6.21	6.63	2.45	4.47	0.94	2.70	0.28	1.24	0.04
120							16.54	21.57	10.60	7.30	7.23	2.88	4.88	1.11	2.95	0.33	1.36	0.05
130							17.92	25.02	11.48	8.47	7.84	3.34	5.29	1.29	3.19	0.38	1.47	0.06
140							19.30	28.70	12.36	9.71	8.44	3.84	5.69	1.47	3.44	0.43	1.59	0.07
150									13.25	11.04	9.04	4.36	6.10	1.68	3.69	0.49	1.70	0.08
160									14.13	12.44	9.64	4.91	6.51	1.89	3.93	0.55	1.81	0.08
170									15.01	13.91	10.25	5.50	6.91	2.11	4.18	0.62	1.93	0.09
180									15.90	15.47	10.85	6.11	7.32	2.35	4.42	0.69	2.04	0.11
190									16.78	17.10	11.45	6.75	7.73	2.60	4.67	0.76	2.15	0.12
200									17.66	18.80	12.06	7.43	8.14	2.85	4.92	0.84	2.27	0.13
225									19.87	23.38	13.56	9.24	9.15	3.55	5.53	1.04	2.55	0.16
250											15.07	11.23	10.17	4.31	6.15	1.27	2.83	0.19
275											16.58	13.39	11.19	5.15	6.76	1.51	3.12	0.23
300											18.09	15.74	12.21	6.05	7.38	1.78	3.40	0.27
325											19.60	18.25	13.22	7.01	7.99	2.06	3.69	0.31
350													14.24	8.05	8.61	2.36	3.97	0.36
375													15.26	9.14	9.22	2.69	4.25	0.41
400													16.28	10.30	9.84	3.03	4.54	0.46
425													17.29	11.53	10.45	3.39	4.82	0.52
450													18.31	12.81	11.07	3.77	5.11	0.57
475													19.33	14.16	11.68	4.16	5.39	0.63
500														12.30	4.58	5.67	0.70	
550														13.53	5.46	6.24	0.83	
600														14.76	6.42	6.81	0.98	

Note: Outlined area of chart indicates velocities over 5 ft/s. Use with caution.

Velocity of flow values are computed from the general equation  $V = .408 \frac{Q}{d^2}$

Friction pressure loss values are computed from the equation:

$$hf = 0.2083 \left( \frac{100}{C} \right)^{1.852} \frac{Q^{1.852}}{d^{4.866}} \times .433 \text{ for psi loss per 100 ft of pipe}$$



Technical Data

Friction loss characteristics PVC class 160 IPS plastic pipe

# PVC CLASS 160 IPS PLASTIC PIPE

(1120, 1220) SDR 26 C=150

PSI loss per 100 feet of pipe (psi/100 ft)

Technical Data  
U.S. Standard Units

**PVC CLASS 160 IPS PLASTIC PIPE**

Sizes 1 in through 6 in. Flow 1 through 600 gpm.

SIZE	1 in	1¼ in	1½ in	2 in	2½ in	3 in	4 in	6 in
OD	1.315	1.660	1.900	2.375	2.875	3.500	4.500	6.625
ID	1.195	1.532	1.754	2.193	2.655	3.230	4.154	6.115
Wall Thk	0.06	0.064	0.073	0.091	0.110	0.135	0.173	0.225

flow gpm	velocity fps	psi loss	velocity fps	psi loss	velocity fps	psi loss	velocity fps	psi loss	velocity fps	psi loss	velocity fps	psi loss	velocity fps	psi loss	velocity fps	psi loss
1	0.28	0.02	0.17	0.01	0.13	0.00										
2	0.57	0.06	0.34	0.02	0.26	0.01	0.16	0.00								
3	0.85	0.14	0.52	0.04	0.39	0.02	0.25	0.01								
4	1.14	0.23	0.69	0.07	0.53	0.04	0.33	0.01	0.23	0.00						
5	1.42	0.35	0.86	0.11	0.66	0.05	0.42	0.02	0.28	0.01						
6	1.71	0.49	1.04	0.15	0.79	0.08	0.50	0.03	0.34	0.01	0.22	0.00				
7	1.99	0.66	1.21	0.20	0.92	0.10	0.59	0.03	0.40	0.01	0.27	0.01				
8	2.28	0.84	1.39	0.25	1.06	0.13	0.67	0.04	0.46	0.02	0.31	0.01				
9	2.57	1.05	1.56	0.31	1.19	0.16	0.76	0.05	0.52	0.02	0.35	0.01				
10	2.85	1.27	1.73	0.38	1.32	0.20	0.84	0.07	0.57	0.03	0.39	0.01				
11	3.14	1.52	1.91	0.45	1.45	0.23	0.93	0.08	0.63	0.03	0.43	0.01				
12	3.42	1.78	2.08	0.53	1.59	0.28	1.01	0.09	0.69	0.04	0.46	0.01	0.28	0.00		
14	3.99	2.37	2.43	0.71	1.85	0.37	1.18	0.12	0.81	0.05	0.54	0.02	0.33	0.01		
16	4.57	3.04	2.78	0.91	2.12	0.47	1.35	0.16	0.92	0.06	0.62	0.02	0.37	0.01		
18	5.14	3.78	3.12	1.13	2.38	0.58	1.52	0.20	1.04	0.08	0.70	0.03	0.42	0.01		
20	5.71	4.59	3.47	1.37	2.65	0.71	1.69	0.24	1.15	0.09	0.78	0.04	0.47	0.01		
22	6.28	5.48	3.82	1.64	2.91	0.85	1.86	0.29	1.27	0.11	0.86	0.04	0.52	0.01		
24	6.85	6.44	4.17	1.92	3.18	1.00	2.03	0.34	1.38	0.13	0.93	0.05	0.56	0.02		
26	7.42	7.47	4.51	2.23	3.44	1.15	2.20	0.39	1.50	0.15	1.01	0.06	0.61	0.02		
28	7.99	8.57	4.86	2.56	3.71	1.32	2.37	0.45	1.62	0.18	1.09	0.07	0.66	0.02		
30	8.57	9.74	5.21	2.91	3.97	1.50	2.54	0.51	1.73	0.20	1.17	0.08	0.70	0.02		
35	9.99	12.95	6.08	3.87	4.64	2.00	2.96	0.68	2.02	0.27	1.36	0.10	0.82	0.03	0.38	0.00
40	11.42	16.59	6.95	4.95	5.30	2.56	3.39	0.86	2.31	0.34	1.56	0.13	0.94	0.04	0.43	0.01
45	12.85	20.63	7.82	6.16	5.96	3.19	3.81	1.08	2.60	0.42	1.75	0.16	1.06	0.05	0.49	0.01
50	14.28	25.07	8.69	7.49	6.63	3.88	4.24	1.31	2.89	0.52	1.95	0.20	1.18	0.06	0.54	0.01
55	15.71	29.91	9.56	8.93	7.29	4.62	4.66	1.56	3.18	0.62	2.15	0.24	1.30	0.07	0.60	0.01
60	17.14	35.14	10.43	10.49	7.95	5.43	5.09	1.83	3.47	0.72	2.34	0.28	1.41	0.08	0.65	0.01
65	18.57	40.76	11.29	12.17	8.62	6.30	5.51	2.12	3.76	0.84	2.54	0.32	1.53	0.09	0.70	0.01
70	19.99	46.76	12.16	13.96	9.28	7.23	5.93	2.44	4.05	0.96	2.73	0.37	1.65	0.11	0.76	0.02
75			13.03	15.86	9.94	8.21	6.36	2.77	4.34	1.09	2.93	0.42	1.77	0.12	0.81	0.02
80			13.90	17.88	10.60	9.25	6.78	3.12	4.63	1.23	3.12	0.47	1.89	0.14	0.87	0.02
85			14.77	20.00	11.27	10.35	7.21	3.49	4.91	1.38	3.32	0.53	2.00	0.16	0.92	0.02
90			15.64	22.23	11.93	11.51	7.63	3.88	5.20	1.53	3.51	0.59	2.12	0.17	0.98	0.03
95			16.51	24.58	12.59	12.72	8.05	4.29	5.49	1.69	3.71	0.65	2.24	0.19	1.03	0.03
100			17.38	27.03	13.26	13.99	8.48	4.72	5.78	1.86	3.91	0.72	2.36	0.21	1.09	0.03
110			19.12	32.24	14.58	16.69	9.33	5.63	6.36	2.22	4.30	0.86	2.60	0.25	1.20	0.04
120					15.91	19.61	10.18	6.61	6.94	2.61	4.69	1.01	2.83	0.30	1.30	0.05
130					17.24	22.74	11.02	7.67	7.52	3.03	5.08	1.17	3.07	0.34	1.41	0.05
140					18.56	26.09	11.87	8.80	8.10	3.47	5.47	1.34	3.31	0.39	1.52	0.06
150					19.89	29.64	12.72	10.00	8.68	3.94	5.86	1.52	3.54	0.45	1.63	0.07
160							13.57	11.27	9.26	4.45	6.25	1.71	3.78	0.50	1.74	0.08
170							14.42	12.61	9.83	4.97	6.64	1.92	4.01	0.56	1.85	0.09
180							15.27	14.02	10.41	5.53	7.03	2.13	4.25	0.63	1.96	0.10
190							16.11	15.49	10.99	6.11	7.43	2.35	4.49	0.69	2.07	0.11
200							16.96	17.03	11.57	6.72	7.82	2.59	4.72	0.76	2.18	0.12
225							19.08	21.19	13.02	8.36	8.79	3.22	5.31	0.95	2.45	0.14
250									14.47	10.16	9.77	3.91	5.91	1.15	2.72	0.18
275									15.91	12.12	10.75	4.67	6.50	1.37	3.00	0.21
300									17.36	14.24	11.73	5.49	7.09	1.61	3.27	0.25
325									18.81	16.51	12.70	6.36	7.68	1.87	3.54	0.29
350											13.68	7.30	8.27	2.15	3.81	0.33
375											14.66	8.29	8.86	2.44	4.09	0.37
400											15.64	9.35	9.45	2.75	4.36	0.42
425											16.62	10.46	10.04	3.07	4.63	0.47
450											17.59	11.62	10.63	3.42	4.90	0.52
475											18.57	12.85	11.23	3.78	5.18	0.58
500											19.55	14.13	11.82	4.15	5.45	0.63
550													13.00	4.96	6.00	0.76
600													14.18	5.82	6.54	0.89

Note: Outlined area of chart indicates velocities over 5 ft/s. Use with caution.

Velocity of flow values are computed from the general equation  $V = .408 \frac{Q}{d^2}$

Friction pressure loss values are computed from the equation:

$$hf = 0.2083 \left( \frac{100}{C} \right)^{1.852} \frac{Q^{1.852}}{d^{4.866}} \times .433 \text{ for psi loss per 100 ft of pipe}$$



Friction loss characteristics PVC class 125 IPS plastic pipe

# PVC CLASS 125 IPS PLASTIC PIPE

(1120, 1220) SDR 32.5 C=150

PSI loss per 100 feet of pipe (psi/100 ft)

## PVC CLASS 125 IPS PLASTIC PIPE

Sizes 1 in through 6 in. Flow 1 through 600 gpm.

SIZE	1 in	1¼ in	1½ in	2 in	2½ in	3 in	4 in	6 in
OD	1.315	1.660	1.900	2.375	2.875	3.500	4.500	6.625
ID	1.211	1.548	1.784	2.229	2.699	3.284	4.224	6.217
Wall Thk	0.052	0.056	0.058	0.073	0.088	0.108	0.138	0.204

flow gpm	velocity fps	psi loss	velocity fps	psi loss	velocity fps	psi loss	velocity fps	psi loss	velocity fps	psi loss	velocity fps	psi loss	velocity fps	psi loss	velocity fps	psi loss
1	0.27	0.02	0.17	0.01	0.12	0.00										
2	0.55	0.06	0.34	0.02	0.25	0.01	0.16	0.00								
3	0.83	0.13	0.51	0.04	0.35	0.02	0.24	0.01								
4	1.11	0.22	0.68	0.07	0.51	0.03	0.32	0.01	0.22	0.00						
5	1.39	0.33	0.85	0.10	0.64	0.05	0.41	0.02	0.28	0.01						
6	1.66	0.46	1.02	0.14	0.76	0.07	0.49	0.02	0.33	0.01						
7	1.94	0.62	1.19	0.19	0.89	0.09	0.57	0.03	0.39	0.01	0.26	0.00				
8	2.22	0.79	1.36	0.24	1.02	0.12	0.65	0.04	0.44	0.02	0.30	0.01				
9	2.50	0.98	1.53	0.30	1.15	0.15	0.73	0.05	0.50	0.02	0.34	0.01				
10	2.78	1.19	1.70	0.36	1.28	0.18	0.82	0.06	0.56	0.02	0.37	0.01				
11	3.06	1.42	1.87	0.43	1.41	0.22	0.90	0.07	0.61	0.03	0.41	0.01				
12	3.33	1.67	2.04	0.51	1.53	0.25	0.98	0.09	0.67	0.03	0.45	0.01	0.27	0.00		
14	3.89	2.22	2.38	0.67	1.79	0.34	1.14	0.11	0.78	0.05	0.52	0.02	0.32	0.01		
16	4.45	2.85	2.72	0.86	2.05	0.43	1.31	0.15	0.89	0.06	0.60	0.02	0.36	0.01		
18	5.00	3.54	3.06	1.07	2.30	0.54	1.47	0.18	1.00	0.07	0.68	0.03	0.41	0.01		
20	5.56	4.31	3.40	1.30	2.56	0.65	1.64	0.22	1.12	0.09	0.75	0.03	0.45	0.01		
22	6.12	5.14	3.74	1.56	2.82	0.78	1.80	0.26	1.23	0.10	0.83	0.04	0.50	0.01		
24	6.67	6.04	4.08	1.83	3.07	0.92	1.97	0.31	1.34	0.12	0.90	0.05	0.54	0.01		
26	7.23	7.00	4.42	2.12	3.33	1.06	2.13	0.36	1.45	0.14	0.98	0.05	0.59	0.02		
28	7.78	8.03	4.76	2.43	3.58	1.22	2.29	0.41	1.56	0.16	1.05	0.06	0.64	0.02		
30	8.34	9.13	5.10	2.76	3.84	1.39	2.46	0.47	1.68	0.18	1.13	0.07	0.68	0.02		
35	9.73	12.14	5.95	3.68	4.48	1.84	2.87	0.62	1.96	0.25	1.32	0.09	0.80	0.03	0.36	0.00
40	11.12	15.55	6.81	4.71	5.12	2.36	3.28	0.80	2.24	0.31	1.51	0.12	0.91	0.04	0.42	0.01
45	12.51	19.34	7.66	5.86	5.76	2.94	3.69	0.99	2.52	0.39	1.70	0.15	1.02	0.04	0.47	0.01
50	13.91	23.50	8.51	7.12	6.40	3.57	4.10	1.21	2.80	0.48	1.89	0.18	1.14	0.05	0.52	0.01
55	15.30	28.04	9.36	8.49	7.05	4.26	4.51	1.44	3.08	0.57	2.08	0.22	1.25	0.06	0.58	0.01
60	16.69	32.94	10.21	9.98	7.69	5.00	4.92	1.69	3.36	0.67	2.26	0.26	1.37	0.08	0.63	0.01
65	18.08	38.21	11.06	11.57	8.33	5.80	5.33	1.96	3.64	0.77	2.45	0.30	1.48	0.09	0.68	0.01
70	19.47	43.83	11.91	13.27	8.97	6.65	5.74	2.25	3.92	0.89	2.64	0.34	1.60	0.10	0.73	0.02
75			12.76	15.08	9.61	7.56	6.15	2.56	4.20	1.01	2.83	0.39	1.71	0.11	0.79	0.02
80			13.62	17.00	10.25	8.52	6.56	2.88	4.48	1.14	3.02	0.44	1.82	0.13	0.84	0.02
85			14.47	19.02	10.89	9.53	6.98	3.23	4.76	1.27	3.21	0.49	1.94	0.14	0.89	0.02
90			15.32	21.14	11.53	10.60	7.39	3.59	5.04	1.41	3.40	0.54	2.05	0.16	0.95	0.02
95			16.17	23.37	12.17	11.71	7.80	3.96	5.32	1.56	3.59	0.60	2.17	0.18	1.00	0.03
100			17.02	25.69	12.81	12.88	8.21	4.36	5.60	1.72	3.78	0.66	2.28	0.19	1.05	0.03
110			18.72	30.65	14.10	15.37	9.03	5.20	6.16	2.05	4.16	0.79	2.51	0.23	1.16	0.04
120					15.38	18.06	9.85	6.11	6.72	2.41	4.53	0.93	2.74	0.27	1.26	0.04
130					16.66	20.94	10.67	7.09	7.28	2.79	4.91	1.08	2.97	0.32	1.37	0.05
140					17.94	24.02	11.49	8.13	7.84	3.20	5.29	1.23	3.20	0.36	1.47	0.06
150					19.22	27.30	12.31	9.24	8.40	3.64	5.67	1.40	3.43	0.41	1.58	0.06
160							13.13	10.41	8.96	4.10	6.05	1.58	3.65	0.46	1.68	0.07
170							13.96	11.65	9.52	4.59	6.43	1.77	3.88	0.52	1.79	0.08
180							14.78	12.95	10.08	5.10	6.80	1.96	4.11	0.58	1.90	0.09
190							15.60	14.31	10.64	5.64	7.18	2.17	4.34	0.64	2.00	0.10
200							16.42	15.74	11.20	6.20	7.56	2.39	4.57	0.70	2.11	0.11
225							18.47	19.57	12.60	7.72	8.51	2.97	5.14	0.87	2.37	0.13
250									14.00	9.38	9.45	3.61	5.71	1.06	2.63	0.16
275									15.40	11.19	10.40	4.31	6.28	1.27	2.90	0.19
300									16.80	13.15	11.34	5.06	6.86	1.49	3.16	0.23
325									18.20	15.25	12.29	5.87	7.43	1.72	3.43	0.26
350									19.60	17.49	13.24	6.73	8.00	1.98	3.69	0.30
375											14.18	7.65	8.57	2.25	3.95	0.34
400											15.13	8.62	9.14	2.53	4.22	0.39
425											16.07	9.65	9.71	2.83	4.48	0.43
450											17.02	10.72	10.29	3.15	4.75	0.48
475											17.96	11.85	10.86	3.48	5.01	0.53
500											18.91	13.03	11.43	3.83	5.27	0.58
550													12.57	4.57	5.80	0.70
600													13.72	5.37	6.33	0.82

Note: Outlined area of chart indicates velocities over 5 ft/s. Use with caution.

Velocity of flow values are computed from the general equation  $V = .408 \frac{Q}{d^2}$

Friction pressure loss values are computed from the equation:

$$hf = 0.2083 \left( \frac{100}{C} \right)^{1.852} \frac{Q^{1.852}}{d^{4.866}} \times .433 \text{ for psi loss per 100 ft of pipe}$$

Technical Data

Friction loss characteristics polyethylene (PE) SDR-pressure-rated tube

# POLYETHYLENE (PE) SDR-PRESSURE RATED TUBE

(2306, 3206, 3306) SDR 7, 9, 11.5, 15 C=140  
PSI loss per 100 feet of tube (psi/100 ft)

Technical Data  
U.S. Standard Units

**POLYETHYLENE (PE) SDR-PRESSURE RATED TUBE**

Sizes 1/2 in through 6 in. Flow 1 through 600 gpm.

SIZE	1/2 in		3/4 in		1 in		1 1/4 in		1 1/2 in		2 in		2 1/2 in		3 in		4 in		6 in	
ID	0.622		0.824		1.049		1.380		1.610		2.067		2.469		3.068		4.026		6.065	
flow gpm	velocity fps	psi loss	velocity fps	psi loss	velocity fps	psi loss	velocity fps	psi loss	velocity fps	psi loss	velocity fps	psi loss	velocity fps	psi loss	velocity fps	psi loss	velocity fps	psi loss	velocity fps	psi loss
1	1.05	0.49	0.80	0.12	0.37	0.04	0.21	0.01	0.15	0.00	0.09	0.00								
2	2.10	1.76	1.20	0.45	0.74	0.14	0.42	0.04	0.31	0.02	0.19	0.01								
3	3.16	3.73	1.80	0.95	1.11	0.29	0.64	0.08	0.47	0.04	0.28	0.01	0.20	0.00						
4	4.21	6.35	2.40	1.62	1.48	0.50	0.85	0.13	0.62	0.06	0.38	0.02	0.26	0.01						
5	5.27	9.60	3.00	2.44	1.85	0.76	1.07	0.20	0.78	0.09	0.47	0.03	0.33	0.01	0.21	0.00				
6	6.32	13.46	3.60	3.43	2.22	1.06	1.28	0.28	0.94	0.13	0.57	0.04	0.40	0.02	0.26	0.01				
7	7.38	17.91	4.20	4.56	2.59	1.41	1.49	0.37	1.10	0.18	0.66	0.05	0.46	0.02	0.30	0.01				
8	8.43	22.93	4.80	5.84	2.96	1.80	1.71	0.47	1.25	0.22	0.76	0.07	0.53	0.03	0.34	0.01				
9	9.49	28.52	5.40	7.26	3.33	2.24	1.92	0.59	1.41	0.28	0.85	0.08	0.60	0.03	0.39	0.01				
10	10.54	34.67	6.00	8.82	3.70	2.73	2.14	0.72	1.57	0.34	0.95	0.10	0.66	0.04	0.43	0.01				
11	11.60	41.36	6.00	10.53	4.07	3.25	2.35	0.86	1.73	0.40	1.05	0.12	0.73	0.05	0.47	0.02	0.27	0.00		
12	12.65	48.60	7.21	12.37	4.44	3.82	2.57	1.01	1.88	0.48	1.14	0.14	0.80	0.06	0.52	0.02	0.30	0.01		
14	14.76	64.65	8.41	16.46	5.19	5.08	2.99	1.34	2.20	0.63	1.33	0.19	0.93	0.08	0.60	0.03	0.35	0.01		
16	16.87	82.79	9.61	21.07	5.93	6.51	3.42	1.71	2.51	0.81	1.52	0.24	1.07	0.10	0.69	0.04	0.40	0.01		
18	18.98	102.97	10.81	26.21	6.67	8.10	3.85	2.13	2.83	1.01	1.71	0.30	1.20	0.13	0.78	0.04	0.45	0.01		
20			12.01	31.86	7.41	9.84	4.28	2.59	3.14	1.22	1.90	0.36	1.33	0.15	0.86	0.05	0.50	0.01		
22			13.21	38.01	8.15	11.74	4.71	3.09	3.46	1.46	2.10	0.43	1.47	0.18	0.95	0.06	0.55	0.02		
24			14.42	44.65	8.89	13.79	5.14	3.63	3.77	1.72	2.29	0.51	1.60	0.21	1.04	0.07	0.60	0.02		
26			15.62	48.15	9.64	16.00	5.57	4.21	4.09	1.99	2.48	0.59	1.74	0.25	1.12	0.09	0.65	0.02		
28			16.82	59.41	10.38	18.35	5.99	4.83	4.40	2.28	2.67	0.68	1.87	0.29	1.21	0.10	0.70	0.03		
30			18.02	67.50	11.12	20.85	6.42	5.49	4.72	2.59	2.86	0.77	2.00	0.32	1.30	0.11	0.75	0.03	0.33	0.00
35					12.97	27.74	7.49	7.31	5.50	3.45	3.34	1.02	2.34	0.43	1.51	0.15	0.88	0.04	0.38	0.01
40					14.83	35.53	8.56	9.36	6.29	4.42	3.81	1.31	2.67	0.55	1.73	0.19	1.00	0.05	0.44	0.01
45					16.68	44.19	9.64	11.64	7.08	5.50	4.29	1.63	3.01	0.69	1.95	0.24	1.13	0.06	0.49	0.01
50					18.53	53.71	10.71	14.14	7.87	6.68	4.77	1.98	3.34	0.83	2.16	0.29	1.25	0.08	0.55	0.01
55					11.78	16.87	8.65	7.97	5.25	2.36	3.68	1.00	2.38	0.35	1.38	0.09	0.61	0.01		
60					12.85	19.82	9.44	9.36	5.72	2.78	4.01	1.17	2.60	0.41	1.51	0.11	0.66	0.01		
65					13.92	22.99	10.23	10.86	6.20	3.22	4.35	1.36	2.81	0.47	1.63	0.13	0.72	0.02		
70					14.99	26.37	11.01	12.46	6.68	3.69	4.68	1.56	3.03	0.54	1.76	0.14	0.77	0.02		
75					16.06	29.97	11.80	14.16	7.16	4.20	5.01	1.77	3.25	0.61	1.88	0.16	0.83	0.02		
80					17.13	33.77	12.59	15.95	7.63	4.73	5.35	1.99	3.46	0.69	2.01	0.18	0.88	0.03		
85					18.21	37.79	13.37	17.85	8.11	5.29	5.68	2.23	3.68	0.77	2.13	0.21	0.94	0.03		
90					19.28	42.01	14.16	19.84	8.59	5.88	6.02	2.48	3.90	0.86	2.26	0.23	0.99	0.03		
95							14.95	21.93	9.07	6.50	6.35	2.74	4.11	0.95	2.39	0.25	1.05	0.03		
100							15.74	24.12	9.54	7.15	6.69	3.01	4.33	1.05	2.51	0.28	1.10	0.04		
110							17.31	28.77	10.50	8.53	7.36	3.59	4.76	1.25	2.76	0.33	1.22	0.05		
120							18.88	33.80	11.45	10.02	8.03	4.22	5.20	1.47	3.02	0.39	1.33	0.05		
130									12.41	11.62	8.70	4.90	5.63	1.70	3.27	0.45	1.44	0.06		
140									13.36	13.33	9.37	5.62	6.06	1.95	3.52	0.52	1.55	0.07		
150									14.32	15.15	10.03	6.38	6.50	2.22	3.77	0.59	1.66	0.08		
160									15.27	17.08	10.70	7.19	6.93	2.50	4.02	0.67	1.77	0.09		
170									16.23	19.11	11.37	8.05	7.36	2.80	4.27	0.75	1.88	0.10		
180									17.18	21.24	12.04	8.95	7.80	3.11	4.53	0.83	1.99	0.11		
190									18.14	23.48	12.71	9.89	8.23	3.44	4.78	0.92	2.10	0.12		
200									19.09	25.81	13.38	10.87	8.66	3.78	5.03	1.01	2.21	0.14		
225													15.05	13.52	9.75	4.70	5.66	1.25	2.49	0.17
250													16.73	16.44	10.83	5.71	6.29	1.52	2.77	0.21
275													18.40	19.61	11.92	6.82	6.92	1.82	3.05	0.25
300															13.00	8.01	7.55	2.13	3.32	0.29
325															14.08	9.29	8.18	2.48	3.60	0.34
350															15.17	10.65	8.81	2.84	3.88	0.39
375															16.25	12.10	9.43	3.23	4.15	0.44
400															17.33	13.64	10.06	3.64	4.43	0.50
425															18.42	15.26	10.69	4.07	4.71	0.55
450															19.50	16.97	11.32	4.52	4.99	0.62
475																	11.95	5.00	5.26	0.68
500																	12.58	5.50	5.54	0.75
550																	13.84	6.56	6.10	0.89
600																	15.10	7.70	6.65	1.05

Note: Outlined area of chart indicates velocities over 5 ft/s. Use with caution.

Velocity of flow values are computed from the general equation  $V = .408 \frac{Q}{d^2}$

Friction pressure loss values are computed from the equation:

$$\left[ hf = 0.2083 \left( \frac{100}{C} \right)^{1.852} \frac{Q^{1.852}}{d^{4.866}} \right] \times .433 \text{ for psi loss per 100 ft of pipe}$$

Friction loss characteristics schedule 40 standard steel pipe

# SCHEDULE 40 STANDARD STEEL PIPE

PSI loss per 100 feet of tube (psi/100 ft)

## SCHEDULE 40 STANDARD STEEL PIPE

Sizes 1/2 in through 6 in. Flow 1 through 600 gpm.

SIZE	1/2 in	3/4 in	1 in	1 1/4 in	1 1/2 in	2 in	2 1/2 in	3 in	4 in	6 in
OD	0.840	1.050	1.315	1.660	1.900	2.375	2.875	3.500	4.500	6.625
ID	0.622	0.824	1.049	1.380	1.610	2.067	2.469	3.068	4.026	6.065
Wall Thk	0.109	0.113	0.133	0.140	0.145	0.154	0.203	0.216	0.237	0.280

flow gpm	velocity fps	psi loss	velocity fps	psi loss	velocity fps	psi loss	velocity fps	psi loss	velocity fps	psi loss	velocity fps	psi loss	velocity fps	psi loss	velocity fps	psi loss	velocity fps	psi loss	velocity fps	psi loss	
1	1.05	0.91	0.60	0.23	0.37	0.07	0.21	0.02	0.15	0.01	0.09	0.00									
2	2.10	3.28	1.20	0.84	0.74	0.26	0.42	0.07	0.31	0.03	0.19	0.01	0.13	0.00							
3	3.16	6.95	1.80	1.77	1.11	0.55	0.64	0.14	0.47	0.07	0.28	0.02	0.20	0.01	0.13	0.00					
4	4.21	11.85	2.40	3.02	1.48	0.93	0.85	0.25	0.62	0.12	0.38	0.03	0.26	0.01	0.17	0.01					
5	5.27	17.91	3.00	4.56	1.85	1.41	1.07	0.37	0.78	0.18	0.47	0.05	0.33	0.02	0.21	0.01					
6	6.32	25.10	3.60	6.39	2.22	1.97	1.28	0.52	0.94	0.25	0.57	0.07	0.40	0.03	0.26	0.01					
7	7.38	33.40	4.20	8.50	2.59	2.63	1.49	0.69	1.10	0.33	0.66	0.10	0.46	0.04	0.30	0.01					
8	8.43	42.77	4.80	10.89	2.96	3.36	1.71	0.89	1.25	0.42	0.76	0.12	0.53	0.05	0.34	0.02	0.20	0.00			
9	9.49	53.19	5.40	13.54	3.33	4.18	1.92	1.10	1.41	0.52	0.85	0.15	0.60	0.06	0.39	0.02	0.22	0.01			
10	10.54	64.65	6.00	16.46	3.70	5.08	2.14	1.34	1.57	0.63	0.95	0.19	0.66	0.08	0.43	0.03	0.25	0.01			
11	11.60	77.13	6.60	19.63	4.07	6.07	2.35	1.60	1.73	0.75	1.05	0.22	0.73	0.09	0.47	0.03	0.27	0.01			
12	12.65	90.62	7.21	23.07	4.44	7.13	2.57	1.88	1.88	0.89	1.14	0.26	0.80	0.11	0.52	0.04	0.30	0.01			
14	14.76	20.56	8.41	30.69	5.19	9.48	2.99	2.50	2.20	1.18	1.33	0.35	0.93	0.15	0.60	0.05	0.35	0.01			
16	16.87	54.39	9.61	39.30	5.93	12.14	3.42	3.20	2.51	1.51	1.52	0.45	1.07	0.19	0.69	0.07	0.40	0.02			
18	18.98	92.02	10.81	48.88	6.67	15.10	3.85	3.98	2.83	1.88	1.71	0.56	1.20	0.23	0.78	0.08	0.45	0.02			
20			12.01	59.41	7.41	18.35	4.28	4.83	3.14	2.28	1.90	0.68	1.33	0.29	0.86	0.10	0.50	0.03			
22			13.21	70.88	8.15	21.90	4.71	5.77	3.46	2.72	2.10	0.81	1.47	0.34	0.95	0.12	0.55	0.03	0.24	0.00	
24			14.42	83.27	8.89	25.72	5.14	6.77	3.77	3.20	2.29	0.95	1.60	0.40	1.04	0.14	0.60	0.04	0.26	0.01	
26			15.62	96.57	9.64	29.83	5.57	7.86	4.09	3.71	2.48	1.10	1.74	0.46	1.12	0.16	0.65	0.04	0.28	0.01	
28			16.82	110.8	10.38	34.22	5.99	9.01	4.40	4.26	2.67	1.26	1.87	0.53	1.21	0.18	0.70	0.05	0.31	0.01	
30			18.02	125.9	11.12	38.89	6.42	10.24	4.72	4.84	2.86	1.43	2.00	0.60	1.30	0.21	0.75	0.06	0.33	0.01	
35					12.97	51.74	7.49	13.62	5.50	6.44	3.34	1.91	2.34	0.80	1.51	0.28	0.88	0.07	0.38	0.01	
40					14.83	66.25	8.56	17.45	6.29	8.24	3.81	2.44	2.67	1.03	1.73	0.36	1.00	0.10	0.44	0.01	
45					16.68	82.40	9.64	21.70	7.08	10.25	4.29	3.04	3.01	1.28	1.95	0.44	1.13	0.12	0.49	0.02	
50					18.53	100.2	10.71	26.37	7.87	12.46	4.77	3.69	3.34	1.56	2.16	0.54	1.25	0.14	0.55	0.02	
55							11.78	31.47	8.65	14.86	5.25	4.41	3.68	1.86	2.38	0.65	1.38	0.17	0.61	0.02	
60							12.85	36.97	9.44	17.46	5.72	5.18	4.01	2.18	2.60	0.76	1.51	0.20	0.66	0.03	
65							13.92	42.88	10.23	20.25	6.20	6.00	4.35	2.53	2.81	0.88	1.63	0.23	0.72	0.03	
70							14.99	49.18	11.01	23.23	6.68	6.89	4.68	2.90	3.03	1.01	1.76	0.27	0.77	0.04	
75							16.06	55.89	11.80	26.40	7.16	7.83	5.01	3.30	3.25	1.15	1.88	0.31	0.83	0.04	
80							17.13	62.98	12.59	29.75	7.63	8.82	5.35	3.72	3.46	1.29	2.01	0.34	0.88	0.05	
85							18.21	70.47	13.37	33.29	8.11	9.87	5.68	4.16	3.68	1.44	2.13	0.39	0.94	0.05	
90							19.28	78.33	14.16	37.00	8.59	10.97	6.02	4.62	3.90	1.61	2.26	0.43	0.99	0.06	
95									14.95	40.90	9.07	12.13	6.35	5.11	4.11	1.78	2.39	0.47	1.05	0.06	
100									15.74	44.97	9.54	13.33	6.69	5.62	4.33	1.95	2.51	0.52	1.10	0.07	
110									17.31	53.66	10.50	15.91	7.36	6.70	4.76	2.33	2.76	0.62	1.22	0.08	
120									18.88	63.04	11.45	18.69	8.03	7.87	5.20	2.74	3.02	0.73	1.33	0.10	
130											12.41	21.68	8.70	9.13	5.63	3.17	3.27	0.85	1.44	0.12	
140											13.36	24.87	9.37	10.47	6.06	3.64	3.52	0.97	1.55	0.13	
150											14.32	28.26	10.03	11.90	6.50	4.14	3.77	1.10	1.66	0.15	
160											15.27	31.84	10.70	13.41	6.93	4.66	4.02	1.24	1.77	0.17	
170											16.23	35.63	11.37	15.01	7.36	5.22	4.27	1.39	1.88	0.19	
180											17.18	39.61	12.04	16.68	7.80	5.80	4.53	1.55	1.99	0.21	
190											18.14	43.78	12.71	18.44	8.23	6.41	4.78	1.71	2.10	0.23	
200											19.09	48.14	13.38	20.28	8.66	7.05	5.03	1.88	2.21	0.26	
225														15.05	25.22	9.75	8.76	5.66	2.34	2.49	0.32
250														16.73	30.65	10.83	10.55	6.29	2.84	2.77	0.39
275														18.40	36.57	11.92	12.71	6.92	3.39	3.05	0.46
300																13.00	14.93	7.55	3.98	3.32	0.54
325																14.08	17.32	8.18	4.62	3.60	0.63
350																15.17	19.87	8.81	5.30	3.88	0.72
375																16.25	22.57	9.43	6.02	4.15	0.82
400																17.33	25.44	10.06	6.78	4.43	0.92
425																18.42	28.46	10.69	7.59	4.71	1.03
450																19.50	31.64	11.32	8.43	4.99	1.15
475																		11.95	9.32	5.26	1.27
500																		12.58	10.25	5.54	1.40
550																		13.84	12.23	6.10	1.67
600																		15.10	14.37	6.65	1.96

U.S. Standard Units  
Technical Data

Note: Outlined area of chart indicates velocities over 5 ft/s. Use with caution.

Velocity of flow values are computed from the general equation  $V = .408 \frac{Q}{d^2}$

Friction pressure loss values are computed from the equation:

$$hf = 0.2083 \left( \frac{100}{C} \right)^{1.852} \frac{Q^{1.852}}{d^{4.866}} \times .433 \text{ for psi loss per 100 ft of pipe}$$



Friction loss characteristics type K copper water tube

# TYPE K COPPER WATER TUBE

PSI loss per 100 feet of tube (psi/100 ft)

## TYPE K COPPER WATER TUBE C=140

Sizes 1/2 in thru 3 in. Flow 1 through 600 gpm.

Technical Data  
U.S. Standard Units

SIZE	1/2 in	5/8 in	3/4 in	1 in	1 1/4 in	1 1/2 in	2 in	2 1/2 in	3 in
OD	0.625	0.750	0.875	1.125	1.375	1.625	2.125	2.625	3.125
ID	0.527	0.652	0.745	0.995	1.245	1.481	1.959	2.435	2.907
Wall Thk	0.049	0.049	0.065	0.065	0.065	0.072	0.083	0.095	0.109

flow gpm	velocity fps	psi loss	velocity fps	psi loss	velocity fps	psi loss	velocity fps	psi loss	velocity fps	psi loss	velocity fps	psi loss	velocity fps	psi loss	velocity fps	psi loss	velocity fps	psi loss
1	1.46	1.09	0.95	0.39	0.73	0.20	0.41	0.05	0.26	0.02	0.18	0.01	0.10	0.00				
2	2.93	3.94	1.91	1.40	1.47	0.73	0.82	0.18	0.52	0.06	0.37	0.03	0.21	0.01				
3	4.40	8.35	2.87	2.97	2.20	1.55	1.23	0.38	0.78	0.13	0.55	0.05	0.31	0.01	0.20	0.00		
4	5.87	14.23	3.83	5.05	2.94	2.64	1.64	0.65	1.05	0.22	0.74	0.09	0.42	0.02	0.27	0.01	0.19	0.00
5	7.34	21.51	4.79	7.64	3.67	3.99	2.06	0.98	1.31	0.33	0.93	0.14	0.53	0.04	0.34	0.01	0.24	0.01
6	8.81	30.15	5.75	10.70	4.41	5.60	2.47	1.37	1.57	0.46	1.11	0.20	0.63	0.05	0.41	0.02	0.28	0.01
7	10.28	40.11	6.71	14.24	5.14	7.44	2.88	1.82	1.84	0.61	1.30	0.26	0.74	0.07	0.48	0.02	0.33	0.01
8	11.75	51.37	7.67	18.24	5.88	9.53	3.29	2.33	2.10	0.78	1.48	0.34	0.85	0.09	0.55	0.03	0.38	0.01
9	13.22	63.89	8.63	22.68	6.61	11.86	3.70	2.90	2.36	0.97	1.67	0.42	0.95	0.11	0.61	0.04	0.43	0.02
10	14.69	77.66	9.59	27.57	7.35	14.41	4.12	3.53	2.63	1.18	1.86	0.51	1.06	0.13	0.68	0.05	0.48	0.02
11	16.15	92.65	10.55	32.89	8.08	17.19	4.53	4.21	2.89	1.41	2.04	0.61	1.16	0.16	0.75	0.05	0.53	0.02
12	17.62	108.85	11.51	38.64	8.82	20.20	4.94	4.94	3.15	1.66	2.23	0.71	1.27	0.18	0.82	0.06	0.57	0.03
14			13.43	51.41	10.29	26.87	5.76	6.57	3.68	2.21	2.60	0.95	1.48	0.24	0.95	0.08	0.67	0.04
16			15.35	65.83	11.76	34.41	6.59	8.42	4.21	2.83	2.97	1.22	1.70	0.31	1.10	0.11	0.77	0.05
18			17.27	81.88	13.23	42.80	7.41	10.47	4.73	3.52	3.34	1.51	1.91	0.39	1.23	0.13	0.86	0.06
20			19.19	99.53	14.70	52.02	8.24	12.73	5.26	4.28	3.72	1.84	2.11	0.47	1.37	0.16	0.96	0.07
22					16.17	62.06	9.06	15.18	5.79	5.10	4.09	2.19	2.33	0.56	1.51	0.20	1.06	0.08
24					17.64	72.92	9.89	17.84	6.31	5.99	4.46	2.58	2.55	0.66	1.65	0.23	1.15	0.10
26					19.11	84.57	10.71	10.69	6.84	6.95	4.83	2.99	2.76	0.77	1.78	0.27	1.25	0.11
28							11.53	23.73	7.37	7.98	5.20	3.43	2.97	0.88	1.92	0.30	1.35	0.13
30							12.36	26.97	7.89	9.06	5.58	3.89	3.18	1.00	2.06	0.35	1.44	0.15
35							14.42	35.88	9.21	12.06	6.51	5.18	3.72	1.33	2.40	0.46	1.68	0.19
40							16.48	45.95	10.52	15.44	7.44	6.63	4.25	1.70	2.75	0.59	1.93	0.25
45							18.54	57.15	11.84	19.20	8.37	8.25	4.78	2.12	3.00	0.73	2.17	0.31
50									13.16	23.34	9.30	10.03	5.31	2.57	3.44	0.89	2.41	0.38
55									14.47	27.85	10.23	11.97	5.84	3.07	3.78	1.06	2.65	0.45
60									15.79	32.71	11.16	14.06	6.37	3.60	4.12	1.25	2.89	0.53
65									17.10	37.94	12.09	16.31	6.91	4.18	4.47	1.45	3.13	0.61
70									18.42	43.52	13.02	18.70	7.44	4.80	4.81	1.66	3.37	0.70
75									19.74	49.46	13.95	21.25	7.97	5.45	5.16	1.89	3.62	0.80
80									14.88	23.95	8.50	6.14	5.50	2.13	3.86	0.90		
85									15.81	26.80	9.03	6.87	5.84	2.38	4.10	1.01		
90									16.74	29.79	9.56	7.64	6.19	2.65	4.34	1.12		
95									17.67	32.93	10.09	8.44	6.53	2.93	4.58	1.24		
100									18.60	36.21	10.63	9.28	6.88	3.22	4.82	1.36		
110											11.69	11.08	7.56	3.84	5.31	1.62		
120											12.75	13.01	8.25	4.52	5.79	1.91		
130											13.82	15.09	8.94	5.24	6.27	2.21		
140											14.88	17.31	9.63	6.01	6.75	2.54		
150											15.94	19.67	10.32	6.83	7.24	2.88		
160											17.01	22.17	11.00	7.69	7.72	3.25		
170											18.07	24.81	11.69	8.61	8.20	3.64		
180											19.13	27.58	12.38	9.57	8.69	4.04		
190													13.07	10.58	9.17	4.47		
200													13.76	11.63	9.65	4.91		
225													15.48	14.47	10.86	6.11		
250													17.20	17.58	12.07	7.43		
275													18.92	20.98	13.27	8.86		
300															14.48	10.41		
325															15.69	12.07		
350															16.89	13.85		
375															18.10	15.73		
400															19.31	17.73		
425																		
450																		
475																		
500																		
550																		
600																		

Note: Outlined area of chart indicates velocities over 5 ft/s. Use with caution.

Velocity of flow values are computed from the general equation  $V = .408 \frac{Q}{d}^2$

Friction pressure loss values are computed from the equation:

$$\left[ hf = 0.2083 \left( \frac{100}{C} \right)^{1.852} \frac{Q^{1.852}}{d^{4.866}} \right] \times .433 \text{ for psi loss per 100 ft of pipe}$$

**Pressure loss in valves and fittings**

Equivalent length in feet of standard steel pipes								
Nominal pipe size	Globe valve	Angle valve	Sprinkler angle valve	Gate valve	Side outlet std. tee	Run of std. tee	Std. elbow	45° elbow
1/2	17	9	2	0.4	4	1	2	1
3/4	22	12	3	0.5	5	2	3	1
1	27	15	4	0.6	6	2	3	2
1 1/4	38	18	5	0.8	8	3	4	2
1 1/2	45	22	6	1.0	10	3	5	2
2	58	28	7	1.2	12	4	6	3
2 1/2	70	35	9	1.4	14	5	7	3
3	90	45	11	1.8	18	6	8	4
4	120	60	15	2.3	23	7	11	5
6	170	85	20	3.3	33	12	17	8

**Pressure loss through copper and bronze fittings**

Nominal Tube Size	Equivalent feet of straight tubing										
	Wrought copper					Cast bronze					
	90° Elbow	45° Elbow	Tee Run	Tee Side Outlet	90° Bend	180° Bend	90° Elbow	45° Elbow	Tee Run	Tee Side Outlet	Compression Stop
3/8	1/2	1/2	1/2	1	1/2	1/2	1	1/2	1/2	2	9
1/2	1/2	1/2	1/2	1	1/2	1	1	1	1/2	2	13
5/8	1/2	1/2	1/2	2	1	1	2	1	1/2	3	17
3/4	1	1/2	1/2	2	1	2	2	1	1/2	3	21
1	1	1	1/2	3	2	2	4	2	1/2	5	30
1 1/4	2	1	1	4	2	3	5	2	1	7	—
1 1/2	2	2	1	5	2	4	8	3	1	9	—
2	2	2	1	7	3	8	11	5	2	12	—
2 1/2	2	3	2	9	4	16	14	8	2	16	—
3	3	4	—	—	5	20	18	11	2	20	—
1 1/2	4	—	—	—	7	24	24	14	2	31	—
4	—	—	—	—	8	28	28	17	2	37	—
5	—	—	—	—	10	37	41	22	2	48	—
6	—	—	—	—	13	47	52	28	2	61	—

**Climate PET**

Climate	Inches Daily
Cool Humid	.10 to .15 in
Cool Dry	.15 to .20 in
Warm Humid	.15 to .20 in
Warm Dry	.20 to .25 in
Hot Humid	.20 to .30 in
Hot Dry	.30 to .45 in "worst case"

Cool = under 70° F as an average midsummer high  
 Warm = between 70° and 90° F as midsummer highs  
 Hot = over 90° F  
 Humid = over 50% as average midsummer relative humidity [dry = under 50%]

**Estimated service line sizes**

Length of string	2 3/4 in	3 1/4 in	3 1/2 in	4 in	4 3/8 in	5 in
Size of service line copper	3/4 in		1 in		1 1/4 in	
Size of service line galvanized		3/4 in		1 in		1 1/4 in

**Technical Data**  
**U.S. Standard Units**

**Technical Data**

**Pressure loss through swing check valves (in psi)**

**Technical Data  
U.S. Standard Units**

Flow gpm	Valve size						Flow gpm	Valve size					
	1/2	3/4	1	1 1/4	1 1/2	2		1 1/4	1 1/2	2	2 1/2	3	4
2	0.2						46	2.1	1.1	0.4			
3	0.5						48	2.2	1.2	0.5			
6	1.0	0.3					50	2.4	1.3	0.5			
8	1.7	0.5					55	2.9	1.5	0.6			
10	2.6	0.8	0.3				60	3.4	1.8	0.7			
12	3.6	1.1	0.5				65	3.9	2.0	0.8			
14	4.8	1.5	0.6				70	4.5	2.4	0.9	0.4		
16		2.0	0.9				75		2.7	1.0	0.5		
18		2.4	1.0				80		3.0	1.2	0.6		
20		3.0	1.2	0.4			90		3.7	1.5	0.7		
22		3.5	1.4	0.5			100		4.6	1.8	0.9	0.4	
24		4.1	1.7	0.6			120			2.5	1.2	0.5	
26		4.8	2.0	0.7	0.4		140			3.3	1.6	0.7	
28			2.2	0.8	0.5		160			4.3	2.1	0.9	0.3
30			2.5	0.9	0.5		180			5.3	2.6	1.1	0.4
32			2.9	1.1	0.6		200			6.5	3.1	1.4	0.5
34			3.2	1.2	0.6		250				4.7	2.1	0.7
36			3.6	1.3	0.7		300				6.6	2.9	1.0
38			3.9	1.5	0.8		350					3.8	1.3
40			4.3	1.6	0.8	0.3	400					4.9	1.7
42			4.7	1.7	0.9	0.3	450						2.1

**Soil characteristics**

SOIL TYPE	SOIL TEXTURE	SOIL COMPONENTS	INTAKE RATE	WATER RETENTION	DRAINAGE EROSION
Sandy soil	Coarse texture	Sand	Very high	Very low	Low erosion Good drainage
		Loamy sand	High	Low	
Loamy soil	Moderately coarse	Sandy loam	Moderately high	Moderately low	Low erosion Good drainage
		Fine loam	Moderately high	Moderately low	
	Medium texture	Very fine loam	Medium	Moderately high	Moderate drainage
		Loam	Medium	Moderately high	Moderate drainage
		Silty loam	Medium	Moderately high	Moderate drainage
	Silt	Medium	Moderately high	Moderate drainage	
Moderately fine	Clay loam	Moderately low	High		
	Sandy clay loam	Moderately low	High		
	Silty clay loam	Moderately low	High		
Clay soil	Fine texture	Sandy clay	Low	High	Drainage
		Silty clay	Low	High	Severe erosion
		Clay			

Maximum precipitation rates

SOIL TEXTURE	MAXIMUM PRECIPITATION RATES: INCHES PER HOUR							
	0 to 5% slope		5 to 8% slope		8 to 12% slope		12%+ slope	
	cover	bare	cover	bare	cover	bare	cover	bare
Course sandy soils	2.00	2.00	2.00	1.50	1.50	1.00	1.00	0.50
Course sandy soils over compact subsoils	1.75	1.50	1.25	1.00	1.00	0.75	0.75	0.40
Light sandy loams uniform	1.75	1.00	1.25	0.80	1.00	0.60	0.75	0.40
Light sandy loams over compact subsoils	1.25	0.75	1.00	0.50	0.75	0.40	0.50	0.30
Uniform silt loams	1.00	0.50	0.80	0.40	0.60	0.30	0.40	0.20
Silt loams over compact subsoil	0.60	0.30	0.50	0.25	0.40	0.15	0.30	0.10
Heavy clay or clay loam	0.20	0.15	0.15	0.10	0.12	0.08	0.10	0.06

The maximum PR values listed above are as suggested by the United States Department of Agriculture. The values are average and may vary with respect to actual soil condition and condition of ground cover.

Technical Data  
 U.S. Standard Units

Friction loss characteristics of bronze gate valves (in psi)

GPM	Bronze Gate Valves (loss in psi)								
	Valve Size (in inches)								
	1/2	3/4	1	1 1/4	1 1/2	2	2 1/2	3	4
1									
2	.01								
5	.06	.02							
8	.16	.05	.02						
10	.24	.08	.03	.01					
15		.17	.06	.02	.01				
20		.31	.11	.03	.02				
30			.24	.07	.04	.01			
40			.43	.13	.07	.02	.01		
50			.67	.21	.11	.04	.02		
60				.30	.15	.05	.03	.01	
80				.54	.28	.10	.05	.02	
100					.43	.15	.07	.03	
120					.62	.22	.10	.04	.02
140					.85	.30	.14	.06	
160						.40	.18	.07	.03
180						.50	.23	.09	
200						.62	.29	.11	.04
220							.42	.14	.05
240								.17	.06
260								.19	.07
280								.23	.09
300								.26	.10
350									.14
400									.18
450									.23
500									.28
550									.34
600									.40

Slope reference

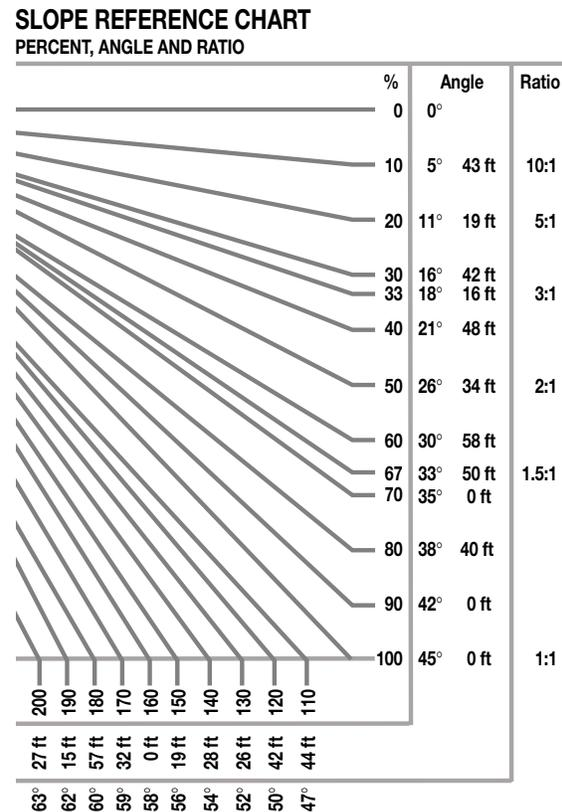

## Technical Data

### Pressure loss through water meters AWWA standard pressure loss

#### Pressure loss: psi Nominal Size

##### flow

gpm	½ in	¾ in	1 in	1½ in	2 in	3 in	4 in
1	0.2	0.1					
2	0.3	0.2					
3	0.4	0.3					
4	0.6	0.5	0.1				
5	0.9	0.6	0.2				
6	1.3	0.7	0.3				
7	1.8	0.8	0.4				
8	2.3	1.0	0.5				
9	3.0	1.3	0.6				
10	3.7	1.6	0.7				
11	4.4	1.9	0.8				
12	5.1	2.2	0.9				
13	6.1	2.6	1.0				
14	7.2	3.1	1.1				
15	8.3	3.6	1.2				
16	9.4	4.1	1.4	0.4			
17	10.7	4.6	1.6	0.5			
18	12.0	5.2	1.8	0.6			
19	13.4	5.8	2.0	0.7			
20	15.0	6.5	2.2	0.8			
22		7.9	2.8	1.0			
24		9.5	3.4	1.2			
26		11.2	4.0	1.4			
28		13.0	4.6	1.6			
30		15.0	5.3	1.8			
32			6.0	2.1	0.8		
34			6.9	2.4	0.9		
36			7.8	2.7	1.0		
38			8.7	3.0	1.2		
40			9.6	3.3	1.3		
42			10.6	3.6	1.4		
44			11.7	3.9	1.5		
46			12.8	4.2	1.6		
48			13.9	4.5	1.7		
50			15.0	4.9	1.9	0.7	
52				5.3	2.1		
54				5.7	2.2		
56				6.2	2.3		
58				6.7	2.5		
60				7.2	2.7		
65			8.3	3.2	1.1		
70			9.8	3.7	1.3		
75			11.2	4.3	1.5		
80			12.8	4.9	1.6	0.7	
90			16.1	6.2	2.0	0.8	
100			20.0	7.8	2.5	0.9	
110				9.5	2.9	1.0	
120				11.3	3.4	1.2	
130				13.0	3.9	1.4	
140				15.1	4.5	1.6	
150				17.3	5.1	1.8	
160				20.0	5.8	2.1	
170					6.5	2.4	
180					7.2	2.7	
190					8.0	3.0	
200					9.0	3.2	
220						11.0	3.9
240						13.0	4.7
260						15.0	5.5
280						17.3	6.3
300						20.0	7.2
350							10.0
400							13.0
450							16.2
500							20.0

Technical Data  
U.S. Standard Units

### Friction loss characteristics PVC schedule 80 IPS plastic pipe

# PVC SCHEDULE 80 IPS PLASTIC PIPE

(1120, 1220) C=150

Bar loss per 100 meter of pipe (bar/100 m)

#### PVC CLASS 80 IPS PLASTIC PIPE

Sizes 15 mm through 160 mm. Flow 0,06 L/s (0,23 m³/h) through 37,85 L/s (136,08 m³/h).

SIZE	15 mm	20 mm	25 mm	32 mm	40 mm	50 mm	63 mm	75 mm	110 mm	160 mm											
OD	21	27	33	42	48	60	73	89	114	168											
ID	14	19	24	32	38	49	59	74	97	146											
Wall Thk	4	4	5	5	5	6	7	8	9	11											
flow l/s	flow m³/h	velocity mps	bar loss	velocity mps	bar loss	velocity mps	bar loss	velocity mps	bar loss	velocity mps	bar loss	velocity mps	bar loss	velocity mps	bar loss	velocity mps	bar loss	velocity mps	bar loss	velocity mps	bar loss
0,063	0,227	0,415	0,183	0,226	0,041	0,134	0,011	0,073	0,002	0,055	0,002	0,030	0,000								
0,126	0,454	0,832	0,660	0,451	0,149	0,271	0,043	0,149	0,011	0,110	0,005	0,064	0,002	0,046	0,000						
0,189	0,680	1,250	1,399	0,677	0,314	0,405	0,090	0,226	0,023	0,165	0,011	0,098	0,002	0,067	0,002						
0,252	0,907	1,667	2,382	0,902	0,536	0,543	0,156	0,302	0,038	0,219	0,018	0,131	0,005	0,091	0,002						
0,315	1,134	2,085	3,600	1,128	0,809	0,677	0,235	0,378	0,057	0,274	0,027	0,165	0,007	0,113	0,002	0,073	0,000				
0,378	1,361	2,502	5,047	1,353	1,135	0,814	0,330	0,454	0,081	0,329	0,036	0,198	0,011	0,137	0,005	0,088	0,002				
0,442	1,588	2,920	6,714	1,579	1,510	0,948	0,438	0,530	0,106	0,384	0,050	0,229	0,014	0,158	0,007	0,101	0,002				
0,505	1,814	3,335	8,599	1,804	1,935	1,085	0,560	0,607	0,138	0,442	0,063	0,262	0,018	0,183	0,007	0,116	0,002				
0,568	2,041	3,752	10,697	2,030	2,405	1,219	0,698	0,683	0,172	0,497	0,079	0,296	0,023	0,207	0,009	0,131	0,002				
0,631	2,268	4,170	13,000	2,259	2,922	1,356	0,848	0,759	0,208	0,552	0,095	0,329	0,027	0,229	0,011	0,146	0,005	0,082	0,000		
0,694	2,495	4,587	15,510	2,484	3,487	1,494	1,010	0,835	0,249	0,607	0,113	0,363	0,032	0,253	0,014	0,162	0,005	0,091	0,002		
0,757	2,722	5,005	18,222	2,710	4,097	1,628	1,189	0,911	0,292	0,661	0,133	0,396	0,038	0,274	0,016	0,177	0,005	0,101	0,002		
0,883	3,175			3,161	5,451	1,899	1,580	1,064	0,386	0,771	0,179	0,460	0,052	0,320	0,020	0,204	0,007	0,119	0,002		
1,009	3,629			3,612	6,979	2,170	2,023	1,216	0,495	0,884	0,228	0,527	0,066	0,366	0,027	0,235	0,009	0,134	0,002		
1,135	4,082			4,063	8,681	2,441	2,518	1,369	0,617	0,994	0,285	0,594	0,081	0,415	0,034	0,265	0,011	0,152	0,002		
1,262	4,536			4,517	10,552	2,713	3,060	1,521	0,748	1,103	0,344	0,661	0,099	0,460	0,041	0,296	0,014	0,168	0,005		
1,388	4,990			4,968	12,588	2,987	3,650	1,673	0,893	1,213	0,409	0,725	0,118	0,506	0,050	0,323	0,016	0,186	0,005		
1,514	5,443			5,419	14,789	3,258	4,287	1,826	1,049	1,326	0,481	0,792	0,138	0,552	0,057	0,354	0,020	0,201	0,005		
1,640	5,897			5,870	17,153	3,530	4,974	1,978	1,218	1,436	0,558	0,860	0,160	0,597	0,066	0,384	0,023	0,219	0,007		
1,766	6,350					3,801	5,704	2,131	1,397	1,545	0,640	0,924	0,183	0,643	0,077	0,411	0,025	0,238	0,007		
1,892	6,804					4,072	6,484	2,283	1,587	1,655	0,728	0,991	0,208	0,689	0,086	0,442	0,029	0,253	0,007	0,110	0
2,208	7,938					4,752	8,624	2,664	2,111	1,932	0,970	1,155	0,278	0,805	0,115	0,515	0,038	0,296	0,011	0,131	0,002
2,523	9,072					5,428	11,045	3,045	2,703	2,210	1,241	1,323	0,355	0,920	0,147	0,591	0,050	0,338	0,014	0,149	0,002
2,839	10,206							3,426	3,363	2,487	1,544	1,487	0,443	1,036	0,183	0,664	0,063	0,381	0,016	0,168	0,002
3,154	11,340							3,807	4,088	2,761	1,876	1,652	0,538	1,152	0,224	0,738	0,077	0,424	0,020	0,186	0,002
3,469	12,474							4,185	4,877	3,039	2,237	1,817	0,642	1,265	0,267	0,811	0,090	0,466	0,023	0,204	0,002
3,785	13,608							4,566	5,729	3,313	2,628	1,984	0,753	1,381	0,312	0,887	0,106	0,509	0,027	0,223	0,005
4,100	14,742							4,947	6,644	3,591	3,049	2,149	0,875	1,497	0,364	0,960	0,124	0,552	0,032	0,241	0,005
4,416	15,876							5,328	7,621	3,868	3,496	2,313	1,003	1,612	0,416	1,033	0,142	0,594	0,036	0,262	0,005
4,731	17,010							5,709	8,660	4,142	3,973	2,478	1,139	1,728	0,472	1,106	0,160	0,637	0,041	0,280	0,007
5,046	18,144							6,090	9,761	4,420	4,477	2,646	1,284	1,841	0,533	1,183	0,181	0,677	0,047	0,299	0,007
5,362	19,278									4,697	5,008	2,810	1,437	1,957	0,594	1,256	0,203	0,719	0,052	0,317	0,007
5,677	20,412									4,974	5,569	2,975	1,598	2,073	0,662	1,329	0,226	0,762	0,059	0,335	0,009
5,993	21,546									5,249	6,154	3,139	1,765	2,188	0,732	1,402	0,249	0,805	0,066	0,354	0,009
6,308	22,680									5,526	6,769	3,307	1,941	2,304	0,807	1,478	0,273	0,847	0,070	0,372	0,009
6,939	24,948									6,078	8,075	3,636	2,317	2,533	0,961	1,625	0,328	0,933	0,086	0,411	0,011
7,570	27,216											3,968	2,721	2,765	1,130	1,774	0,384	1,018	0,099	0,448	0,014
8,200	29,484											4,298	3,155	2,993	1,266	1,920	0,445	1,103	0,115	0,485	0,016
8,831	31,752											4,630	3,621	3,225	1,503	2,070	0,513	1,189	0,133	0,524	0,018
9,462	34,020											4,959	4,113	3,456	1,709	2,216	0,581	1,274	0,151	0,561	0,02
10,093	36,288											5,291	4,635	3,685	1,923	2,365	0,653	1,356	0,170	0,597	0,023
10,724	38,556											5,621	5,187	3,917	2,154	2,512	0,732	1,442	0,190	0,634	0,025
11,354	40,824											5,953	5,765	4,145	2,393	2,661	0,814	1,527	0,210	0,674	0,029
11,985	43,092													4,377	2,646	2,807	0,899	1,612	0,233	0,710	0,032
12,616	45,360													4,609	2,909	2,957	0,988	1,698	0,258	0,747	0,036
14,193	51,030													5,185	3,618	3,325	1,229	1,911	0,319	0,841	0,043
15,770	56,700													5,761	4,398	3,694	1,494	2,121	0,389	0,936	0,052
17,347	62,370														4,066	1,783	2,335	0,463	1,030	0,063	
18,924	68,040														4,435	2,095	2,548	0,545	1,122	0,075	
20,501	73,710														4,804	2,430	2,758	0,631	1,216	0,086	
22,078	79,380														5,172	2,787	2,972	0,723	1,311	0,099	
23,655	85,050														5,544	3,166	3,185	0,823	1,402	0,113	
25,232	90,720														5,913	3,569	3,395	0,927	1,497	0,127	
26,809	96,390															3,609	1,037	1,591	1,037	0,142	
28,386	102,060															3,822	1,153	1,686	1,153	0,158	
29,963	107,730															4,033	1,275	1,777	1,275	0,174	
31,540																					



Friction loss characteristics PVC class 315 IPS plastic pipe

# PVC CLASS 315 IPS PLASTIC PIPE

(1120, 1220) SDR 13.5 C=150

Bar loss per 100 meter of pipe (bar/100 m)

**PVC CLASS 315 IPS PLASTIC PIPE**

Sizes 15 mm through 160 mm. Flow 0,06 L/s (0,23 m³/h) through 37,85 L/s (136,08 m³/h).

SIZE	15 mm	20 mm	25 mm	32 mm	40 mm	50 mm	63 mm	75 mm	110 mm	160 mm											
OD	21	1	33	42	48	60	73	89	114	168											
ID	18	23	28	36	41	51	62	76	97	143											
Wall Thk	2	2	2	3	4	4	5	7	8	12											
flow l/s	flow m³/h	velocity mps	bar loss	velocity mps	bar loss	velocity mps	bar loss	velocity mps	bar loss	velocity mps	bar loss	velocity mps	bar loss	velocity mps	bar loss	velocity mps	bar loss	velocity mps	bar loss	velocity mps	bar loss
0,063	0,227	0,241	0,050	0,155	0,016	0,098	0,005	0,061	0,002	0,046	0,000										
0,126	0,454	0,485	0,176	0,311	0,061	0,195	0,020	0,122	0,007	0,094	0,002	0,058	0,000								
0,189	0,680	0,725	0,373	0,466	0,127	0,296	0,043	0,186	0,014	0,140	0,007	0,088	0,002	0,061	0,000						
0,252	0,907	0,969	0,637	0,622	0,217	0,393	0,072	0,247	0,023	0,189	0,011	0,119	0,005	0,082	0,002						
0,315	1,134	1,210	0,963	0,777	0,328	0,494	0,108	0,311	0,036	0,235	0,018	0,149	0,007	0,104	0,002	0,067	0,000				
0,378	1,361	1,454	1,349	0,933	0,459	0,591	0,151	0,372	0,050	0,283	0,025	0,180	0,009	0,122	0,005	0,082	0,002				
0,442	1,588	1,698	1,797	1,088	0,610	0,692	0,203	0,433	0,066	0,332	0,034	0,210	0,011	0,143	0,005	0,098	0,002				
0,505	1,814	1,939	2,301	1,244	0,780	0,789	0,260	0,497	0,084	0,378	0,043	0,241	0,014	0,165	0,007	0,110	0,002				
0,568	2,041	2,182	2,861	1,399	0,972	0,890	0,323	0,558	0,104	0,427	0,054	0,271	0,018	0,186	0,007	0,125	0,002				
0,631	2,268	2,423	3,476	1,554	1,180	0,988	0,393	0,622	0,127	0,472	0,066	0,302	0,023	0,207	0,009	0,137	0,002	0,082	0,000		
0,694	2,495	2,667	4,147	1,710	1,408	1,088	0,468	0,683	0,151	0,521	0,079	0,332	0,027	0,226	0,011	0,152	0,005	0,091	0,002		
0,757	2,722	2,911	4,873	1,865	1,654	1,186	0,549	0,744	0,179	0,570	0,093	0,363	0,032	0,247	0,011	0,168	0,005	0,101	0,002		
0,883	3,175	3,395	6,484	2,176	2,201	1,384	0,732	0,869	0,237	0,664	0,122	0,424	0,041	0,290	0,016	0,195	0,007	0,116	0,002		
1,009	3,629	3,880	8,303	2,487	2,818	1,582	0,938	0,994	0,303	0,759	0,158	0,485	0,052	0,329	0,020	0,223	0,009	0,134	0,002		
1,135	4,082	4,365	10,326	2,798	3,505	1,780	1,166	1,119	0,377	0,853	0,197	0,546	0,066	0,372	0,027	0,250	0,009	0,149	0,002		
1,262	4,536	4,849	12,552	3,109	4,262	1,978	1,417	1,244	0,459	0,948	0,237	0,607	0,079	0,415	0,032	0,277	0,011	0,168	0,005		
1,388	4,990	5,334	14,975	3,423	5,085	2,176	1,690	1,366	0,547	1,042	0,283	0,668	0,095	0,454	0,038	0,305	0,014	0,186	0,005		
1,514	5,443	5,822	17,592	3,734	5,973	2,374	1,987	1,490	0,642	1,140	0,332	0,728	0,113	0,497	0,045	0,335	0,018	0,201	0,005		
1,640	5,897			4,045	6,927	2,573	2,303	1,615	0,744	1,234	0,386	0,789	0,131	0,536	0,052	0,363	0,020	0,219	0,007		
1,766	6,350			4,356	7,946	2,771	2,642	1,740	0,854	1,329	0,443	0,850	0,149	0,579	0,059	0,390	0,023	0,235	0,007	0,107	0,000
1,892	6,804			4,666	9,029	2,969	3,004	1,865	0,970	1,423	0,504	0,911	0,170	0,622	0,068	0,418	0,025	0,253	0,007	0,116	0,002
2,208	7,938			5,444	12,012	3,463	3,996	2,176	1,290	1,661	0,669	1,061	0,226	0,725	0,088	0,488	0,034	0,296	0,009	0,134	0,002
2,523	9,072					3,956	5,117	2,487	1,652	1,899	0,859	1,213	0,289	0,829	0,115	0,558	0,043	0,338	0,014	0,155	0,002
2,839	10,206					4,453	6,362	2,798	2,057	2,137	1,067	1,366	0,359	0,933	0,142	0,628	0,054	0,378	0,016	0,174	0,002
3,154	11,340					4,947	7,734	3,109	2,500	2,374	1,297	1,518	0,438	1,036	0,172	0,698	0,066	0,421	0,020	0,195	0,002
3,469	12,474					5,441	9,228	3,420	2,981	2,612	1,548	1,670	0,522	1,140	0,206	0,768	0,079	0,463	0,023	0,213	0,005
3,785	13,608					5,938	10,841	3,731	3,503	2,850	1,817	1,823	0,612	1,244	0,242	0,838	0,093	0,506	0,027	0,232	0,005
4,100	14,742							4,042	4,061	3,088	2,109	1,975	0,712	1,347	0,280	0,908	0,108	0,549	0,032	0,253	0,005
4,416	15,876							4,353	4,660	3,322	2,418	2,124	0,816	1,451	0,321	0,978	0,124	0,591	0,036	0,271	0,005
4,731	17,010							4,663	5,295	3,560	2,748	2,277	0,927	1,554	0,366	1,049	0,140	0,634	0,041	0,293	0,007
5,046	18,144							4,974	5,966	3,798	3,098	2,429	1,044	1,658	0,411	1,119	0,158	0,677	0,047	0,311	0,007
5,362	19,278							5,285	6,676	4,036	3,465	2,582	1,168	1,762	0,461	1,186	0,176	0,716	0,052	0,329	0,009
5,677	20,412							5,596	7,422	4,273	3,853	2,734	1,300	1,865	0,513	1,256	0,197	0,759	0,059	0,351	0,009
5,993	21,546							5,907	8,204	4,511	4,258	2,886	1,435	1,969	0,567	1,326	0,217	0,802	0,063	0,369	0,009
6,308	22,680							4,749	4,683	3,036	1,580	2,073	1,396	1,396	0,624	1,396	0,240	0,844	0,070	0,390	0,011
6,939	24,948									5,224	5,587	3,341	1,885	2,280	0,744	1,536	0,285	0,930	0,084	0,427	0,014
7,570	27,216									5,700	6,563	3,645	2,213	2,487	0,875	1,676	0,334	1,015	0,099	0,466	0,016
8,200	29,484											3,950	2,567	2,694	1,012	1,817	0,389	1,097	0,115	0,506	0,018
8,831	31,752											4,252	2,945	2,902	1,162	1,957	0,445	1,183	0,131	0,546	0,020
9,462	34,020											4,557	3,347	3,109	1,320	2,097	0,506	1,268	0,149	0,585	0,023
10,093	36,288											4,862	3,772	3,316	1,489	2,237	0,572	1,353	0,167	0,622	0,025
10,724	38,556											5,163	4,219	3,523	1,666	2,374	0,640	1,436	0,188	0,661	0,029
11,354	40,824											5,468	4,690	3,731	1,851	2,515	0,710	1,521	0,210	0,701	0,032
11,985	43,092											5,773	5,184	3,938	2,045	2,655	0,784	1,606	0,231	0,741	0,036
12,616	45,360											6,075	5,702	4,145	2,249	2,795	0,863	1,692	0,253	0,780	0,038
14,193	51,030													4,663	2,798	3,146	1,074	1,902	0,316	0,878	0,047
15,770	56,700													5,182	3,401	3,496	1,304	2,112	0,384	0,975	0,059
17,347	62,370													5,700	4,057	3,844	1,557	2,326	0,459	1,073	0,070
18,924	68,040															4,194	1,828	2,536	0,538	1,170	0,081
20,501	73,710															4,545	2,122	2,749	0,624	1,268	0,095
22,078	79,380															4,892	2,434	2,960	0,716	1,366	0,108
23,655	85,050															5,243	2,764	3,170	0,814	1,463	0,124
25,232	90,720															5,593	3,117	3,383	0,918	1,561	0,140
26,809	96,390															5,941	3,485	3,594	1,026	1,658	0,156
28,386	102,060																				

Technical Data

Friction loss characteristics PVC class 200 IPS plastic pipe

# PVC CLASS 200 IPS PLASTIC PIPE

(1120, 1220) SDR 21 C=150

Bar loss per 100 meter of pipe (bar/100 m)

**PVC CLASS 200 IPS PLASTIC PIPE**

Sizes 20 mm through 160 mm. Flow 0,06 L/s (0,23 m³/h) through 37,85 L/s (136,08 m³/h)

SIZE	20 mm	25 mm	32 mm	40 mm	50 mm	63 mm	75 mm	110 mm	160 mm											
OD	27	33	42	48	60	73	89	114	168											
ID	24	30	38	44	55	66	80	103	152											
Wall Thk	2	2	2	2	3	3	4	5	8											
flow l/s	flow m³/h	velocity mps	bar loss	velocity mps	bar loss	velocity mps	bar loss	velocity mps	bar loss	velocity mps	bar loss	velocity mps	bar loss	velocity mps	bar loss	velocity mps	bar loss	velocity mps	bar loss	
0,063	0,227	0,143	0,014	0,085	0,005	0,055	0,002	0,040	0,000											
0,126	0,454	0,287	0,050	0,174	0,016	0,110	0,005	0,082	0,002	0,052	0,000									
0,189	0,680	0,433	0,104	0,262	0,032	0,165	0,009	0,125	0,005	0,079	0,002	0,055	0,000							
0,252	0,907	0,576	0,179	0,351	0,054	0,219	0,018	0,168	0,009	0,107	0,002	0,073	0,002							
0,315	1,134	0,719	0,271	0,439	0,081	0,274	0,027	0,207	0,014	0,134	0,005	0,091	0,002							
0,378	1,361	0,863	0,380	0,527	0,115	0,329	0,036	0,250	0,018	0,162	0,007	0,110	0,002	0,073	0,000					
0,442	1,588	1,006	0,504	0,616	0,151	0,384	0,050	0,293	0,025	0,186	0,009	0,128	0,002	0,085	0,002					
0,505	1,814	1,149	0,644	0,701	0,194	0,439	0,063	0,335	0,032	0,213	0,011	0,146	0,005	0,098	0,002					
0,568	2,041	1,295	0,802	0,789	0,242	0,494	0,077	0,378	0,041	0,241	0,014	0,165	0,005	0,110	0,002					
0,631	2,268	1,439	0,974	0,878	0,294	0,549	0,095	0,418	0,050	0,268	0,016	0,183	0,007	0,122	0,002					
0,694	2,495	1,582	1,164	0,966	0,353	0,604	0,113	0,460	0,059	0,296	0,020	0,201	0,007	0,134	0,002					
0,757	2,722	1,725	1,367	1,055	0,414	0,661	0,133	0,503	0,068	0,323	0,023	0,219	0,009	0,146	0,005	0,088	0,000			
0,883	3,175	2,012	1,819	1,231	0,549	0,771	0,176	0,588	0,090	0,375	0,032	0,256	0,011	0,171	0,005	0,104	0,002			
1,009	3,629	2,301	2,328	1,405	0,703	0,881	0,226	0,671	0,118	0,430	0,038	0,293	0,016	0,198	0,007	0,119	0,002			
1,135	4,082	2,588	2,895	1,582	0,875	0,991	0,280	0,756	0,145	0,485	0,050	0,329	0,020	0,223	0,007	0,134	0,002			
1,262	4,536	2,874	3,521	1,759	1,064	1,100	0,341	0,838	0,176	0,536	0,059	0,366	0,023	0,247	0,009	0,149	0,002			
1,388	4,990	3,164	4,199	1,932	1,270	1,210	0,407	0,924	0,210	0,591	0,072	0,402	0,027	0,271	0,011	0,165	0,002			
1,514	5,443	3,450	4,934	2,109	1,492	1,323	0,479	1,006	0,246	0,646	0,084	0,439	0,034	0,296	0,014	0,180	0,005			
1,640	5,897	3,740	5,722	2,286	1,729	1,433	0,556	1,091	0,287	0,698	0,097	0,475	0,038	0,320	0,016	0,192	0,005			
1,766	6,350	4,026	6,563	2,463	1,984	1,542	0,637	1,177	0,330	0,753	0,111	0,512	0,043	0,344	0,016	0,207	0,005			
1,892	6,804	4,313	7,458	2,637	2,255	1,652	0,723	1,259	0,375	0,808	0,127	0,549	0,050	0,372	0,020	0,223	0,005	0,104	0,000	
2,208	7,938	5,032	9,924	3,078	2,999	1,926	0,963	1,469	0,497	0,942	0,170	0,643	0,066	0,433	0,025	0,262	0,007	0,119	0,002	
2,523	9,072	5,752	12,708	3,517	3,842	2,204	1,232	1,679	0,637	1,076	0,215	0,735	0,086	0,494	0,032	0,299	0,009	0,137	0,002	
2,839	10,206			3,956	4,778	2,478	1,532	1,890	0,793	1,210	0,269	0,826	0,106	0,558	0,041	0,335	0,011	0,155	0,002	
3,154	11,340			4,395	5,808	2,755	1,862	2,100	0,963	1,344	0,325	0,917	0,129	0,619	0,050	0,375	0,014	0,171	0,002	
3,469	12,474			4,837	6,929	3,030	2,222	2,310	1,150	1,478	0,389	1,009	0,154	0,680	0,059	0,411	0,018	0,189	0,002	
3,785	13,608			5,276	8,141	3,307	2,610	2,521	1,349	1,615	0,457	1,100	0,181	0,744	0,070	0,448	0,020	0,207	0,002	
4,100	14,742			5,715	9,440	3,581	3,028	2,731	1,566	1,750	0,531	1,195	0,210	0,805	0,081	0,485	0,023	0,223	0,005	
4,416	15,876					3,856	3,474	2,941	1,797	1,884	0,608	1,286	0,240	0,866	0,093	0,524	0,027	0,241	0,005	
4,731	17,010					4,133	3,948	3,152	2,041	2,018	0,692	1,378	0,273	0,930	0,104	0,561	0,032	0,259	0,005	
5,046	18,144					4,407	4,448	3,362	2,301	2,152	0,777	1,469	0,307	0,991	0,118	0,597	0,034	0,274	0,005	
5,362	19,278					4,685	4,977	3,572	2,574	2,286	0,870	1,561	0,344	1,052	0,133	0,637	0,038	0,293	0,007	
5,677	20,412					4,959	5,532	3,783	2,861	2,423	0,967	1,652	0,382	1,116	0,147	0,674	0,043	0,311	0,007	
5,993	21,546					5,236	6,116	3,993	3,162	2,557	1,071	1,743	0,423	1,177	0,163	0,710	0,047	0,326	0,007	
6,308	22,680					5,511	6,726	4,203	3,478	2,691	1,177	1,838	0,466	1,241	0,179	0,750	0,052	0,344	0,009	
6,939	24,948					6,062	8,023	4,624	4,149	2,960	1,403	2,021	0,554	1,362	0,212	0,823	0,063	0,378	0,009	
7,570	27,216							5,041	4,875	3,231	1,650	2,204	0,651	1,487	0,251	0,899	0,075	0,415	0,011	
8,200	29,484							5,462	5,655	3,499	1,914	2,390	0,755	1,612	0,292	0,972	0,086	0,448	0,014	
8,831	31,752							5,883	6,486	3,767	2,194	2,573	0,868	1,734	0,332	1,049	0,097	0,485	0,016	
9,462	34,020									4,039	2,495	2,755	0,985	1,859	0,380	1,125	0,111	0,518	0,018	
10,093	36,288									4,307	2,811	2,938	1,110	1,984	0,427	1,198	0,124	0,552	0,018	
10,724	38,556									4,575	3,144	3,124	1,243	2,106	0,477	1,274	0,140	0,588	0,020	
11,354	40,824									4,846	3,496	3,307	1,381	2,231	0,531	1,347	0,156	0,622	0,025	
11,985	43,092									5,115	3,865	3,490	1,526	2,356	0,588	1,423	0,172	0,655	0,027	
12,616	45,360									5,383	4,249	3,676	1,679	2,481	0,644	1,500	0,190	0,692	0,029	
14,193	51,030									6,056	5,284	4,133	2,088	2,789	0,802	1,686	0,235	0,777	0,036	
15,770	56,700											4,593	2,538	3,100	0,974	1,875	0,287	0,863	0,043	
17,347	62,370											5,054	3,026	3,411	1,164	2,060	0,341	0,951	0,052	
18,924	68,040											5,514	3,557	3,722	1,367	2,249	0,402	1,036	0,061	
20,501	73,710											5,974	4,125	4,029	1,584	2,435	0,466	1,125	0,070	
22,078	79,380														4,340	1,819	2,624	0,533	1,210	0,081
23,655	85,050														4,651	2,066	2,810	0,608	1,295	0,093
25,232	90,720														4,962	2,328	2,999	0,685	1,384	0,104
26,809	96,390														5,270	2,606	3,185	0,766	1,469	0,118
28,386	102,060														5,581	2,895	3,374	0,852	1,558	0,129
29,963	107,730														5,892	3,200	3,560	0,940	1,643	0,142
31,540	113,400																3,749	1,035	1,728	0,158
34,694	124,740																4,124	1,234	1,902	0,188
37,848	136,080																4,499	1,451	2,076	0,221

Friction loss characteristics PVC class 160 IPS plastic pipe

# PVC CLASS 160 IPS PLASTIC PIPE

(1120, 1220) SDR 26 C=150

Bar loss per 100 meter of pipe (bar/100 m)

**PVC CLASS 160 IPS PLASTIC PIPE**

Sizes 25 mm through 160 mm. Flow 0,06 L/s (0,23 m³/h) through 37,85 L/s (136,08 m³/h).

SIZE	25 mm	32 mm	40 mm	50 mm	63 mm	75 mm	110 mm	160 mm																																																																																																																																																																																																																																																																																																																																																																																																																																																																																																																																																																																																																																																																																																																																																																																																																																
OD	33	42	48	60	73	89	114	168																																																																																																																																																																																																																																																																																																																																																																																																																																																																																																																																																																																																																																																																																																																																																																																																																																
ID	30	39	45	56	67	82	106	155																																																																																																																																																																																																																																																																																																																																																																																																																																																																																																																																																																																																																																																																																																																																																																																																																																
Wall Thk	2	2	2	2	3	3	4	6																																																																																																																																																																																																																																																																																																																																																																																																																																																																																																																																																																																																																																																																																																																																																																																																																																
flow l/s	0,063	0,126	0,189	0,252	0,315	0,378	0,442	0,505	0,568	0,631	0,694	0,757	0,883	1,009	1,135	1,262	1,388	1,514	1,640	1,766	1,892	2,208	2,523	2,839	3,154	3,469	3,785	4,100	4,416	4,731	5,046	5,362	5,677	5,993	6,308	6,939	7,570	8,200	8,831	9,462	10,093	10,724	11,354	11,985	12,616	14,193	15,770	17,347	18,924	20,501	22,078	23,655	25,232	26,809	28,386	29,963	31,540	34,694	37,848																																																																																																																																																																																																																																																																																																																																																																																																																																																																																																																																																																																																																																																																																																																																																																													
flow m³/h	0,227	0,454	0,680	0,907	1,134	1,361	1,588	1,814	2,041	2,268	2,495	2,722	3,175	3,629	4,082	4,536	4,990	5,443	5,897	6,350	6,804	7,938	9,072	10,206	11,340	12,474	13,608	14,742	15,876	17,010	18,144	19,278	20,412	21,546	22,680	24,948	27,216	29,484	31,752	34,020	36,288	38,556	40,824	43,092	45,360	51,030	56,700	62,370	68,040	73,710	79,380	85,050	90,720	96,390	102,060	107,730	113,400	124,740	136,080																																																																																																																																																																																																																																																																																																																																																																																																																																																																																																																																																																																																																																																																																																																																																																													
velocity mps	0,085	0,174	0,259	0,347	0,433	0,521	0,607	0,695	0,783	0,869	0,957	1,042	1,216	1,393	1,567	1,740	1,914	2,088	2,262	2,435	2,612	3,045	3,481	3,917	4,353	4,788	5,224	5,660	6,093	6,528	6,963	7,398	7,833	8,268	8,703	9,138	9,573	10,008	10,443	10,878	11,313	11,748	12,183	12,618	13,053	13,488	13,923	14,358	14,793	15,228	15,663	16,098	16,533	16,968	17,403	17,838	18,273	18,708	19,143	19,578	20,013	20,448	20,883	21,318	21,753	22,188	22,623	23,058	23,493	23,928	24,363	24,798	25,233	25,668	26,103	26,538	26,973	27,408	27,843	28,278	28,713	29,148	29,583	30,018	30,453	30,888	31,323	31,758	32,193	32,628	33,063	33,498	33,933	34,368	34,803	35,238	35,673	36,108	36,543	36,978	37,413	37,848	38,283	38,718	39,153	39,588	40,023	40,458	40,893	41,328	41,763	42,198	42,633	43,068	43,503	43,938	44,373	44,808	45,243	45,678	46,113	46,548	46,983	47,418	47,853	48,288	48,723	49,158	49,593	50,028	50,463	50,898	51,333	51,768	52,203	52,638	53,073	53,508	53,943	54,378	54,813	55,248	55,683	56,118	56,553	56,988	57,423	57,858	58,293	58,728	59,163	59,598	60,033	60,468	60,903	61,338	61,773	62,208	62,643	63,078	63,513	63,948	64,383	64,818	65,253	65,688	66,123	66,558	66,993	67,428	67,863	68,298	68,733	69,168	69,603	70,038	70,473	70,908	71,343	71,778	72,213	72,648	73,083	73,518	73,953	74,388	74,823	75,258	75,693	76,128	76,563	76,998	77,433	77,868	78,303	78,738	79,173	79,608	80,043	80,478	80,913	81,348	81,783	82,218	82,653	83,088	83,523	83,958	84,393	84,828	85,263	85,698	86,133	86,568	87,003	87,438	87,873	88,308	88,743	89,178	89,613	90,048	90,483	90,918	91,353	91,788	92,223	92,658	93,093	93,528	93,963	94,398	94,833	95,268	95,703	96,138	96,573	97,008	97,443	97,878	98,313	98,748	99,183	99,618	100,053	100,488	100,923	101,358	101,793	102,228	102,663	103,098	103,533	103,968	104,403	104,838	105,273	105,708	106,143	106,578	107,013	107,448	107,883	108,318	108,753	109,188	109,623	110,058	110,493	110,928	111,363	111,798	112,233	112,668	113,103	113,538	113,973	114,408	114,843	115,278	115,713	116,148	116,583	117,018	117,453	117,888	118,323	118,758	119,193	119,628	120,063	120,498	120,933	121,368	121,803	122,238	122,673	123,108	123,543	123,978	124,413	124,848	125,283	125,718	126,153	126,588	127,023	127,458	127,893	128,328	128,763	129,198	129,633	130,068	130,503	130,938	131,373	131,808	132,243	132,678	133,113	133,548	133,983	134,418	134,853	135,288	135,723	136,158	136,593	137,028	137,463	137,898	138,333	138,768	139,203	139,638	140,073	140,508	140,943	141,378	141,813	142,248	142,683	143,118	143,553	143,988	144,423	144,858	145,293	145,728	146,163	146,598	147,033	147,468	147,903	148,338	148,773	149,208	149,643	150,078	150,513	150,948	151,383	151,818	152,253	152,688	153,123	153,558	153,993	154,428	154,863	155,298	155,733	156,168	156,603	157,038	157,473	157,908	158,343	158,778	159,213	159,648	160,083	160,518	160,953	161,388	161,823	162,258	162,693	163,128	163,563	163,998	164,433	164,868	165,303	165,738	166,173	166,608	167,043	167,478	167,913	168,348	168,783	169,218	169,653	170,088	170,523	170,958	171,393	171,828	172,263	172,698	173,133	173,568	174,003	174,438	174,873	175,308	175,743	176,178	176,613	177,048	177,483	177,918	178,353	178,788	179,223	179,658	180,093	180,528	180,963	181,398	181,833	182,268	182,703	183,138	183,573	184,008	184,443	184,878	185,313	185,748	186,183	186,618	187,053	187,488	187,923	188,358	188,793	189,228	189,663	190,098	190,533	190,968	191,403	191,838	192,273	192,708	193,143	193,578	194,013	194,448	194,883	195,318	195,753	196,188	196,623	197,058	197,493	197,928	198,363	198,798	199,233	199,668	200,103	200,538	200,973	201,408	201,843	202,278	202,713	203,148	203,583	204,018	204,453	204,888	205,323	205,758	206,193	206,628	207,063	207,498	207,933	208,368	208,803	209,238	209,673	210,108	210,543	210,978	211,413	211,848	212,283	212,718	213,153	213,588	214,023	214,458	214,893	215,328	215,763	216,198	216,633	217,068	217,503	217,938	218,373	218,808	219,243	219,678	220,113	220,548	220,983	221,418	221,853	222,288	222,723	223,158	223,593	224,028	224,463	224,898	225,333	225,768	226,203	226,638	227,073	227,508	227,943	228,378	228,813	229,248	229,683	230,118	230,553	230,988	231,423	231,858	232,293	232,728	233,163	233,598	234,033	234,468	234,903	235,338	235,773	236,208	236,643	237,078	237,513	237,948	238,383	238,818	239,253	239,688	240,123	240,558	240,993	241,428	241,863	242,298	242,733	243,168	243,603	244,038	244,473	244,908	245,343	245,778	246,213	246,648	247,083	247,518	247,953	248,388	248,823	249,258	249,693	250,128	250,563	250,998	251,433	251,868	252,303	252,738	253,173	253,608	254,043	254,478	254,913	255,348	255,783	256,218	256,653	257,088	257,523	257,958	258,393	258,828	259,263	259,698	260,133	260,568	260,998	261,433	261,868	262,303	262,738	263,173	263,608	264,043	264,478	264,913	265,348	265,783	266,218	266,653	267,088	267,523	267,958	268,393	268,828	269,263	269,698	270,133	270,568	270,998	271,433	271,868	272,303	272,738	273,173	273,608	274,043	274,478	274,913	275,348	275,783	276,218	276,653	277,088	277,523	277,958	278,393	278,828	279,263	279,698	280,133	280,568	280,998	281,433	281,868	282,303	282,738	283,173	283,608	284,043	284,478	284,913	285,348	285,783	286,218	286,653	287,088	287,523	287,958	288,393	288,828	289,263	289,698	290,133	290,568	290,998	291,433	291,868	292,303	292,738	293,173	293,608	294,043	294,478	294,913	295,348	295,783	296,218	296,653	297,088	297,523	297,958	298,393	298,828	299,263	299,698	300,133	300,568	300,998	301,433	301,868	302,303	302,738	303,173	303,608	304,043	304,478	304,913	305,348	305,783	306,218	306,653	307,088	307,523	307,958	308,393	308,828	309,263	309,698	310,133	310,568	310,998	311,433	311,868	312,303	312,738	313,173	313,608	314,043	314,478	314,913	315,348	315,783	316,218	316,653	317,088	317,523	317,958	318,393	318,828	319,263	319,698	320,133	320,568	320,998	321,433	321,868	322,303	322,738	323,173	323,608	324,043	324,478	324,913	325,348	325,783	326,218	326,653	327,088	327,523	327,958	328,393	328,828	329,263	329,698	330,133	330,568	330,998	331,433	331,868	332,303	332,738	333,173	333,608	334,043	334,478	334,913	335,348	335,783	336,218	336,653	337,088	337,523	337,958	338,393	338,828	339,263	339,698	340,133	340,568	340,998	341,433	341,868	342,303	342,738	343,173	343,608	344,043	344,478	344,913

Technical Data

Friction loss characteristics PVC class 125 IPS plastic pipe

# PVC CLASS 125 IPS PLASTIC PIPE

(1120, 1220) SDR 32.5 C=150

Bar loss per 100 meter of pipe (bar/100 m)

**PVC CLASS 125 IPS PLASTIC PIPE**

Sizes 25 mm through 160 mm. Flow 0,06 L/s (0,23 m³/h) through 37,85 L/s (136,08 m³/h).

SIZE	25 mm		32 mm		40 mm		50 mm		63 mm		75 mm		110 mm		160 mm		
OD	33		42		48		60		73		89		114		168		
ID	31		39		45		57		69		83		107		158		
Wall Thk	1		1		1		2		2		3		4		5		
flow l/s	flow m³/h	velocity mps	bar loss	velocity mps	bar loss	velocity mps	bar loss	velocity mps	bar loss	velocity mps	bar loss	velocity mps	bar loss	velocity mps	bar loss	velocity mps	bar loss
0,063	0,227	0,082	0,005	0,052	0,002	0,037	0,000										
0,126	0,454	0,168	0,014	0,104	0,005	0,076	0,002	0,049	0,000								
0,189	0,680	0,253	0,029	0,155	0,009	0,107	0,005	0,073	0,002								
0,252	0,907	0,338	0,050	0,207	0,016	0,155	0,007	0,098	0,002	0,067	0,000						
0,315	1,134	0,424	0,075	0,259	0,023	0,195	0,011	0,125	0,005	0,085	0,002						
0,378	1,361	0,506	0,104	0,311	0,032	0,232	0,016	0,149	0,005	0,101	0,002						
0,442	1,588	0,591	0,140	0,363	0,043	0,271	0,020	0,174	0,007	0,119	0,002	0,079	0,000				
0,505	1,814	0,677	0,179	0,415	0,054	0,311	0,027	0,198	0,009	0,134	0,005	0,091	0,002				
0,568	2,041	0,762	0,221	0,466	0,068	0,351	0,034	0,223	0,011	0,152	0,005	0,104	0,002				
0,631	2,268	0,847	0,269	0,518	0,081	0,390	0,041	0,250	0,014	0,171	0,005	0,113	0,002				
0,694	2,495	0,933	0,321	0,570	0,097	0,430	0,050	0,274	0,016	0,186	0,007	0,125	0,002				
0,757	2,722	1,015	0,377	0,622	0,115	0,466	0,057	0,299	0,020	0,204	0,007	0,137	0,002	0,082	0,000		
0,883	3,175	1,186	0,502	0,725	0,151	0,546	0,077	0,347	0,025	0,238	0,011	0,158	0,005	0,098	0,002		
1,009	3,629	1,356	0,644	0,829	0,194	0,625	0,097	0,399	0,034	0,271	0,014	0,183	0,005	0,110	0,002		
1,135	4,082	1,524	0,800	0,933	0,242	0,701	0,122	0,448	0,041	0,305	0,016	0,207	0,007	0,125	0,002		
1,262	4,536	1,695	0,974	1,036	0,294	0,780	0,147	0,500	0,050	0,341	0,020	0,229	0,007	0,137	0,002		
1,388	4,990	1,865	1,162	1,140	0,353	0,860	0,176	0,549	0,059	0,375	0,023	0,253	0,009	0,152	0,002		
1,514	5,443	2,033	1,365	1,244	0,414	0,936	0,208	0,600	0,070	0,408	0,027	0,274	0,011	0,165	0,002		
1,640	5,897	2,204	1,582	1,347	0,479	1,015	0,240	0,649	0,081	0,442	0,032	0,299	0,011	0,180	0,005		
1,766	6,350	2,371	1,815	1,451	0,549	1,091	0,276	0,698	0,093	0,475	0,036	0,320	0,014	0,195	0,005		
1,892	6,804	2,542	2,063	1,554	0,624	1,170	0,314	0,750	0,106	0,512	0,041	0,344	0,016	0,207	0,005		
2,208	7,938	2,966	2,744	1,814	0,832	1,366	0,416	0,875	0,140	0,597	0,057	0,402	0,020	0,244	0,007	0,110	0,000
2,523	9,072	3,389	3,514	2,076	1,064	1,561	0,533	1,000	0,181	0,683	0,070	0,460	0,027	0,277	0,009	0,128	0,002
2,839	10,206	3,813	4,371	2,335	1,324	1,756	0,664	1,125	0,224	0,768	0,088	0,518	0,034	0,311	0,009	0,143	0,002
3,154	11,340	4,240	5,311	2,594	1,609	1,951	0,807	1,250	0,273	0,853	0,108	0,576	0,041	0,347	0,011	0,158	0,002
3,469	12,474	4,663	6,337	2,853	1,919	2,149	0,963	1,375	0,325	0,939	0,129	0,634	0,050	0,381	0,014	0,177	0,002
3,785	13,608	5,087	7,444	3,112	2,255	2,344	1,130	1,500	0,382	1,024	0,151	0,689	0,059	0,418	0,018	0,192	0,002
4,100	14,742	5,511	8,635	3,371	2,615	2,539	1,311	1,625	0,443	1,109	0,174	0,747	0,068	0,451	0,020	0,207	0,002
4,416	15,876	5,934	9,906	3,630	2,999	2,734	1,503	1,750	0,509	1,195	0,201	0,805	0,077	0,488	0,023	0,223	0,005
4,731	17,010			3,889	3,408	2,929	1,709	1,875	0,579	1,280	0,228	0,863	0,088	0,521	0,025	0,241	0,005
5,046	18,144			4,151	3,842	3,124	1,926	1,999	0,651	1,366	0,258	0,920	0,099	0,555	0,029	0,256	0,005
5,362	19,278			4,410	4,299	3,319	2,154	2,128	0,730	1,451	0,287	0,978	0,111	0,591	0,032	0,271	0,005
5,677	20,412			4,670	4,778	3,514	2,396	2,252	0,811	1,536	0,319	1,036	0,122	0,625	0,036	0,290	0,005
5,993	21,546			4,929	5,282	3,709	2,646	2,377	0,895	1,622	0,353	1,094	0,136	0,661	0,041	0,305	0,007
6,308	22,680			5,188	5,806	3,904	2,911	2,502	0,985	1,707	0,389	1,152	0,149	0,695	0,043	0,320	0,007
6,939	24,948			5,706	6,927	4,298	3,474	2,752	1,175	1,878	0,463	1,268	0,179	0,765	0,052	0,354	0,009
7,570	27,216				4,688	4,082	3,002	1,381	2,048	0,545	1,381	0,210	0,835	0,061	0,384	0,009	
8,200	29,484				5,078	4,732	3,252	1,602	2,219	0,631	1,497	0,244	0,905	0,072	0,418	0,011	
8,831	31,752				5,468	5,429	3,502	1,837	2,390	0,723	1,612	0,278	0,975	0,081	0,448	0,014	
9,462	34,020				5,858	6,170	3,752	2,088	2,560	0,823	1,728	0,316	1,045	0,093	0,482	0,014	
10,093	36,288							4,002	2,353	2,731	0,927	1,844	0,357	1,113	0,104	0,512	0,016
10,724	38,556							4,255	2,633	2,902	1,037	1,960	0,400	1,183	0,118	0,546	0,018
11,354	40,824							4,505	2,927	3,072	1,153	2,073	0,443	1,253	0,131	0,579	0,020
11,985	43,092							4,755	3,234	3,243	1,275	2,188	0,490	1,323	0,145	0,610	0,023
12,616	45,360							5,005	3,557	3,414	1,401	2,304	0,540	1,393	0,158	0,643	0,025
14,193	51,030							5,630	4,423	3,840	1,745	2,594	0,671	1,567	0,197	0,722	0,029
15,770	56,700									4,267	2,120	2,880	0,816	1,740	0,240	0,802	0,036
17,347	62,370									4,694	2,529	3,170	0,974	1,914	0,287	0,884	0,043
18,924	68,040									5,121	2,972	3,456	1,144	2,091	0,337	0,963	0,052
20,501	73,710									5,547	3,447	3,746	1,327	2,265	0,389	1,045	0,059
22,078	79,380									5,974	3,953	4,036	1,521	2,438	0,447	1,125	0,068
23,655	85,050											4,322	1,729	2,612	0,509	1,204	0,077
25,232	90,720											4,612	1,948	2,786	0,572	1,286	0,088
26,809	96,390											4,898	2,181	2,960	0,640	1,366	0,097
28,386	102,060											5,188	2,423	3,136	0,712	1,448	0,108
29,963	107,730											5,474	2,678	3,310	0,786	1,527	0,120
31,540	113,400											5,764	2,945	3,484	0,866	1,606	0,131
34,694	124,740													3,831	1,033	1,768	0,158
37,848	136,080													4,182	1,214	1,929	0,185

Technical Data  
International System Units

Note: Outlined area of chart indicates velocities over 1,5 m/s. Use with caution.

© Copyright 2000 Rain Bird

Velocity of flow values are computed from the general equation  $V = .408 \frac{Q}{d} 2$

Friction pressure loss values are computed from the equation:

$$hf = 0.2083 \left( \frac{100}{C} \right)^{1.852} \frac{Q^{1.852}}{d^{4.866}} \times .098 \text{ for bar loss per 100 m of pipe}$$



Friction loss characteristics polyethylene (PE) SDR-pressure-rated tube

# POLYETHYLENE (PE) SDR-PRESSURE RATED TUBE

(2306, 3206, 3306) SDR 7, 9, 11.5, 15 C=140  
Bar loss per 100 meter of tube (bar/100 m)

## POLYETHYLENE (PE) SDR-PRESSURE RATED TUBE

Sizes 15 mm through 160 mm. Flow 0,06 L/s (0,23 m³/h) through 37,85 L/s (136,08 m³/h).

SIZE	15 mm	20 mm	25 mm	32 mm	40 mm	50 mm	63 mm	75 mm	110 mm	160 mm	
ID	16	21	27	35	41	53	63	78	102	154	
flow	flow	velocity	bar	velocity	bar	velocity	bar	velocity	bar	velocity	bar
l/s	m³/h	m/s	loss	m/s	loss	m/s	loss	m/s	loss	m/s	loss
0,063	0,227	0,320	0,111	0,183	0,027	0,113	0,009	0,064	0,002	0,046	0,000
0,126	0,454	0,640	0,398	0,366	0,102	0,226	0,032	0,128	0,009	0,094	0,005
0,189	0,680	0,963	0,843	0,549	0,215	0,338	0,066	0,195	0,018	0,143	0,009
0,252	0,907	1,283	1,435	0,732	0,366	0,451	0,113	0,259	0,029	0,189	0,014
0,315	1,134	1,606	2,170	0,914	0,551	0,564	0,172	0,326	0,045	0,238	0,020
0,378	1,361	1,926	3,042	1,097	0,775	0,677	0,240	0,390	0,063	0,287	0,029
0,442	1,588	2,249	4,048	1,280	1,031	0,789	0,319	0,454	0,084	0,335	0,041
0,505	1,814	2,569	5,182	1,463	1,320	0,902	0,407	0,521	0,106	0,381	0,050
0,568	2,041	2,893	6,446	1,646	1,641	1,015	0,506	0,585	0,133	0,430	0,063
0,631	2,268	3,213	7,835	1,829	1,993	1,128	0,617	0,652	0,163	0,479	0,077
0,694	2,495	3,536	9,347	1,829	2,380	1,241	0,735	0,716	0,194	0,527	0,090
0,757	2,722	3,856	10,984	2,198	2,796	1,353	0,863	0,783	0,228	0,573	0,108
0,883	3,175	4,499	14,611	2,563	3,720	1,582	1,148	0,911	0,303	0,671	0,142
1,009	3,629	5,142	18,711	2,929	4,762	1,807	1,471	1,042	0,386	0,765	0,183
1,135	4,082	5,785	23,271	3,295	5,923	2,033	1,831	1,173	0,481	0,863	0,228
1,262	4,536			3,661	7,200	2,259	2,224	1,305	0,585	0,957	0,276
1,388	4,990			4,026	8,590	2,484	2,653	1,436	0,698	1,055	0,330
1,514	5,443			4,395	10,091	2,710	3,117	1,567	0,820	1,149	0,389
1,640	5,897			4,761	10,882	2,938	3,616	1,698	0,951	1,247	0,450
1,766	6,350			5,127	13,427	3,164	4,147	1,826	1,092	1,341	0,515
1,892	6,804			5,492	15,255	3,389	4,712	1,957	1,241	1,439	0,585
2,208	7,938					3,953	6,269	2,283	1,652	1,676	0,780
2,523	9,072					4,520	8,030	2,609	2,115	1,917	0,999
2,839	10,206					5,084	9,987	2,938	2,631	2,158	1,243
3,154	11,340					5,648	12,138	3,264	3,196	2,399	1,510
3,469	12,474							3,591	3,813	2,637	1,801
3,785	13,608							3,917	4,479	2,877	2,115
4,100	14,742							4,243	5,196	3,118	2,454
4,416	15,876							4,569	5,960	3,356	2,816
4,731	17,010							4,895	6,773	3,597	3,200
5,046	18,144							5,221	7,632	3,837	3,605
5,362	19,278							5,550	8,541	4,075	4,034
5,677	20,412							5,877	9,494	4,316	4,484
5,993	21,546									4,557	4,956
6,308	22,680									4,798	5,451
6,939	24,948									5,276	6,502
7,570	27,216									5,755	7,639
8,200	29,484									3,783	2,626
8,831	31,752									4,072	3,013
9,462	34,020									4,365	3,424
10,093	36,288									4,654	3,860
10,724	38,556									4,947	4,319
11,354	40,824									5,236	4,800
11,985	43,092									5,529	5,306
12,616	45,360									5,819	5,833
14,193	51,030									4,587	3,056
15,770	56,700									5,099	3,715
17,347	62,370									5,608	4,432
18,924	68,040										
20,501	73,710									4,292	2,100
22,078	79,380									4,624	2,407
23,655	85,050									4,953	2,735
25,232	90,720									5,282	3,083
26,809	96,390									5,614	3,449
28,386	102,060									5,944	3,835
29,963	107,730										
31,540	113,400									3,642	1,130
34,694	124,740									3,834	1,243
37,848	136,080									4,218	1,483
										4,602	1,740
											2,027
											0,237

Note: Outlined area of chart indicates velocities over 1,5 m/s. Use with caution.

© Copyright 2000 Rain Bird

Velocity of flow values are computed from the general equation  $V = .408 \frac{Q}{d^2}$

Friction pressure loss values are computed from the equation:

$$hf = 0.2083 \left( \frac{100}{C} \right)^{1.852} \frac{Q^{1.852}}{d^{4.866}} \times .098 \text{ for bar loss per 100 m of pipe}$$

Technical Data  
International System Units

Friction loss characteristics schedule 40 standard steel pipe

# SCHEDULE 40 STANDARD STEEL PIPE

Bar loss per 100 meter of tube (bar/100 m)

## SCHEDULE 40 STANDARD STEEL PIPE

Sizes 15 mm through 160 mm. Flow 0,06 L/s (0,23 m³/h) through 37,85 L/s (136,08 m³/h).

SIZE	15 mm	20 mm	25 mm	32 mm	40 mm	50 mm	63 mm	75 mm	110 mm	160 mm												
OD	21	27	33	42	48	60	73	89	114	168												
ID	16	21	27	35	41	53	63	78	102	154												
Wall Thk	3	3	3	4	4	4	5	5	6	7												
flow l/s	flow m³/h	velocity mps	bar loss	velocity mps	bar loss	velocity mps	bar loss	velocity mps	bar loss	velocity mps	bar loss											
0,063	0,227	0,320	0,206	0,183	0,052	0,113	0,016	0,064	0,005	0,046	0,002	0,027	0	0,002	0,004	0	0,002	0,004	0	0,002	0,002	
0,126	0,454	0,640	0,741	0,366	0,190	0,226	0,059	0,128	0,016	0,094	0,007	0,058	0,002	0,016	0,007	0,016	0,002	0,002	0,002	0,002	0,002	
0,189	0,680	0,963	1,571	0,549	0,400	0,338	0,124	0,195	0,032	0,143	0,016	0,085	0,005	0,061	0,002	0,004	0,002	0,002	0,002	0,002	0,002	
0,252	0,907	1,283	2,678	0,732	0,683	0,451	0,210	0,259	0,057	0,189	0,027	0,116	0,007	0,079	0,002	0,002	0,002	0,002	0,002	0,002	0,002	
0,315	1,134	1,606	4,048	0,914	1,031	0,564	0,319	0,326	0,084	0,238	0,041	0,143	0,011	0,101	0,005	0,004	0,002	0,002	0,002	0,002	0,002	
0,378	1,361	1,926	5,673	1,097	1,444	0,677	0,445	0,390	0,118	0,287	0,057	0,174	0,016	0,122	0,007	0,007	0,002	0,002	0,002	0,002	0,002	
0,442	1,588	2,249	7,548	1,280	1,921	0,789	0,594	0,454	0,156	0,335	0,075	0,201	0,023	0,14	0,009	0,009	0,002	0,002	0,002	0,002	0,002	
0,505	1,814	2,569	9,666	1,463	2,461	0,902	0,759	0,521	0,201	0,381	0,095	0,232	0,027	0,162	0,011	0,014	0,005	0,005	0,005	0,005	0,005	
0,568	2,041	2,893	12,021	1,646	3,060	1,015	0,945	0,585	0,249	0,43	0,118	0,259	0,034	0,183	0,014	0,019	0,005	0,005	0,005	0,005	0,005	
0,631	2,268	3,213	14,611	1,829	3,720	1,128	1,148	0,652	0,303	0,479	0,142	0,29	0,043	0,201	0,018	0,013	0,007	0,007	0,007	0,007	0,007	
0,694	2,495	3,536	17,431	2,012	4,436	1,241	1,372	0,716	0,362	0,527	0,17	0,32	0,05	0,223	0,02	0,143	0,007	0,007	0,007	0,007	0,007	
0,757	2,722	3,856	20,480	2,198	5,214	1,353	1,611	0,783	0,425	0,573	0,201	0,347	0,059	0,244	0,025	0,158	0,009	0,009	0,009	0,009	0,009	
0,883	3,175	4,499	4,647	2,563	6,936	1,582	2,142	0,911	0,565	0,671	0,267	0,405	0,079	0,283	0,034	0,183	0,011	0,010	0,010	0,010	0,010	
1,009	3,629	5,142	12,292	2,929	8,882	1,807	2,744	1,042	0,723	0,765	0,341	0,463	0,102	0,326	0,043	0,21	0,016	0,012	0,012	0,012	0,012	
1,135	4,082	5,785	20,797	3,295	11,047	2,033	3,413	1,173	0,899	0,863	0,425	0,521	0,127	0,366	0,052	0,238	0,018	0,013	0,013	0,013	0,013	
1,262	4,536			3,661	13,427	2,259	4,147	1,305	1,092	0,957	0,515	0,579	0,154	0,405	0,066	0,262	0,023	0,015	0,015	0,015	0,015	
1,388	4,990			4,026	16,019	2,484	4,949	1,436	1,304	1,055	0,615	0,64	0,183	0,448	0,077	0,29	0,027	0,018	0,018	0,018	0,018	
1,514	5,443			4,395	18,819	2,710	5,813	1,567	1,53	1,149	0,723	0,698	0,215	0,488	0,09	0,317	0,032	0,018	0,018	0,018	0,018	
1,640	5,897			4,761	21,825	2,938	6,742	1,698	1,776	1,247	0,838	0,756	0,249	0,53	0,104	0,341	0,036	0,019	0,019	0,019	0,019	
1,766	6,350			5,127	25,041	3,164	7,734	1,826	2,036	1,341	0,963	0,814	0,285	0,57	0,12	0,369	0,041	0,023	0,023	0,023	0,023	
1,892	6,804			5,492	28,453	3,389	8,789	1,957	2,314	1,439	1,094	0,872	0,323	0,61	0,136	0,396	0,047	0,023	0,023	0,023	0,023	
2,208	7,938					3,953	11,693	2,283	3,078	1,676	1,455	1,018	0,432	0,713	0,181	0,46	0,063	0,026	0,026	0,026	0,026	
2,523	9,072					4,520	14,973	2,609	3,944	1,917	1,862	1,161	0,551	0,814	0,233	0,527	0,081	0,0305	0,0305	0,0305	0,0305	
2,839	10,206					5,084	18,822	2,938	4,904	2,158	2,317	1,308	0,687	0,917	0,289	0,594	0,099	0,0344	0,0344	0,0344	0,0344	
3,154	11,340					5,648	22,645	3,264	5,96	2,399	2,816	1,454	0,834	1,018	0,353	0,658	0,122	0,0381	0,0381	0,0381	0,0381	
3,469	12,474							3,591	7,112	2,637	3,358	1,6	0,997	1,122	0,42	0,725	0,147	0,0421	0,0421	0,0421	0,0421	
3,785	13,608							3,917	8,355	2,877	3,946	1,743	1,171	1,222	0,493	0,792	0,172	0,046	0,046	0,046	0,046	
4,100	14,742							4,243	9,691	3,118	4,577	1,89	1,356	1,326	0,572	0,856	0,199	0,0497	0,0497	0,0497	0,0497	
4,416	15,876							4,569	11,115	3,356	5,25	2,036	1,557	1,426	0,655	0,924	0,228	0,0536	0,0536	0,0536	0,0536	
4,731	17,010							4,895	12,631	3,597	5,966	2,182	1,77	1,527	0,746	0,991	0,26	0,0573	0,0573	0,0573	0,0573	
5,046	18,144							5,221	14,233	3,837	6,724	2,326	1,993	1,631	0,841	1,055	0,292	0,0613	0,0613	0,0613	0,0613	
5,362	19,278							5,550	15,926	4,075	7,524	2,472	2,231	1,731	0,94	1,122	0,325	0,0649	0,0649	0,0649	0,0649	
5,677	20,412							5,877	17,703	4,316	8,362	2,618	2,479	1,835	1,044	1,189	0,364	0,0689	0,0689	0,0689	0,0689	
5,993	21,546									4,557	9,243	2,765	2,741	1,935	1,155	1,253	0,402	0,0728	0,0728	0,0728	0,0728	
6,308	22,680									4,798	10,163	2,908	3,013	2,039	1,27	1,32	0,441	0,0765	0,0765	0,0765	0,0765	
6,939	24,948									5,276	12,127	3,2	3,596	2,243	1,514	1,451	0,527	0,0841	0,0841	0,0841	0,0841	
7,570	27,216									5,755	14,247	3,49	4,224	2,448	1,779	1,585	0,619	0,092	0,092	0,092	0,092	
8,200	29,484											3,783	4,9	2,652	2,063	1,716	0,716	0,0997	0,0997	0,0997	0,0997	
8,831	31,752											4,072	5,621	2,856	2,366	1,847	0,823	1,073	0,219	0,472	0,029	
9,462	34,020											4,365	6,387	3,057	2,689	1,981	0,936	1,149	0,249	0,506	0,034	
10,093	36,288											4,654	7,196	3,261	3,031	2,112	1,053	1,225	0,28	0,539	0,038	
10,724	38,556											4,947	8,052	3,466	3,392	2,243	1,18	1,301	0,314	0,573	0,043	
11,354	40,824											5,236	8,952	3,67	3,77	2,377	1,311	1,381	0,35	0,607	0,047	
11,985	43,092											5,529	9,894	3,874	4,167	2,509	1,449	1,457	0,386	0,64	0,052	
12,616	45,360											5,819	10,88	4,078	4,583	2,64	1,593	1,533	0,425	0,674	0,059	
14,193	51,030													4,587	5,7	2,972	1,98	1,725	0,529	0,759	0,078	
15,770	56,700													5,099	6,927	3,301	2,384	1,917	0,642	0,844	0,088	
17,347	62,370													5,608	8,265	3,633	2,872	2,109	0,766	0,93	0,104	
18,924	68,040															3,962	3,374	2,301	0,899	1,012	0,122	
20,501	73,710															4,292	3,914	2,493	1,044	1,097	0,142	
22,078	79,380																4,624	4,491	2,685	1,198	0,163	
23,655	85,050																4,953	5,101	2,874	1,361	0,185	
25,232	90,720																5,282	5,749	3,066	1,532	0,208	
26,809	96,390																5,614	6,432	3,258	1,715	0,233	
28,386	102,060																5,944	7,151	3,45	1,905	0,26	
29,963	107,730																		3,642	2,106	1,603	0,287
31,540	113,400																		3,834	2,317	1,689	0,316
34,694	124,740																		4,218	2,764	1,859	0,377
37,848	136,080																		4,602	3,248	2,027	0,443

Note: Outlined area of chart indicates velocities over 1,5 m/s. Use with caution.

© Copyright 2000 Rain Bird

Velocity of flow values are computed from the general equation  $V = .408 \frac{Q}{d^2}$

Friction pressure loss values are computed from the equation:

$$hf = 0.2083 \left( \frac{100}{C} \right)^{1.852} \frac{Q^{1.852}}{d^{4.866}} \times .098 \text{ for bar loss per 100 m of pipe}$$

Friction loss characteristics type K copper water tube

# TYPE K COPPER WATER TUBE

Bar loss per 100 meter of tube (bar/100 m)

## TYPE K COPPER WATER TUBE C=140

Sizes 15 mm thru 75 mm. Flow 0,06 L/s (0,23 m³/h) through 37,85 L/s (136,08 m³/h).

SIZE	15 mm	18 mm	20 mm	25 mm	32 mm	40 mm	50 mm	63 mm	75 mm
OD	16	19	22	29	35	41	54	67	79
ID	13	17	19	25	32	38	50	62	74
Wall Thk	1	1	2	2	2	2	2	2	3

flow l/s	flow m³/h	velocity mps	bar loss	velocity mps	bar loss	velocity mps	bar loss	velocity mps	bar loss	velocity mps	bar loss	velocity mps	bar loss	velocity mps	bar loss	velocity mps	bar loss	velocity mps	bar loss
0,063	0,227	0,445	0,246	0,290	0,088	0,223	0,045	0,125	0,011	0,079	0,005	0,055	0,002	0,030	0,000				
0,126	0,454	0,893	0,890	0,582	0,316	0,448	0,165	0,250	0,041	0,158	0,014	0,113	0,007	0,064	0,002				
0,189	0,680	1,341	1,887	0,875	0,671	0,671	0,350	0,375	0,086	0,238	0,029	0,168	0,011	0,094	0,002	0,061	0,000		
0,252	0,907	1,789	3,216	1,167	1,141	0,896	0,597	0,500	0,147	0,320	0,050	0,226	0,020	0,128	0,005	0,082	0,002	0,058	0,000
0,315	1,134	2,237	4,861	1,460	1,727	1,119	0,902	0,628	0,221	0,399	0,075	0,283	0,032	0,162	0,009	0,104	0,002	0,073	0,002
0,378	1,361	2,685	6,814	1,753	2,418	1,344	1,266	0,753	0,310	0,479	0,104	0,338	0,045	0,192	0,011	0,125	0,005	0,085	0,002
0,442	1,588	3,133	9,065	2,045	3,218	1,567	1,681	0,878	0,411	0,561	0,138	0,396	0,059	0,226	0,016	0,146	0,005	0,101	0,002
0,505	1,814	3,581	11,610	2,338	4,122	1,792	2,154	1,003	0,527	0,640	0,176	0,451	0,077	0,259	0,020	0,168	0,007	0,116	0,002
0,568	2,041	4,029	14,439	2,630	5,126	2,015	2,680	1,128	0,655	0,719	0,219	0,509	0,095	0,290	0,025	0,186	0,009	0,131	0,005
0,631	2,268	4,478	17,551	2,923	6,231	2,240	3,257	1,256	0,798	0,802	0,267	0,567	0,115	0,323	0,029	0,207	0,011	0,146	0,005
0,694	2,495	4,923	20,939	3,216	7,433	2,463	3,885	1,381	0,951	0,881	0,319	0,622	0,138	0,354	0,036	0,229	0,011	0,162	0,005
0,757	2,722	5,371	24,600	3,508	8,733	2,688	4,565	1,506	1,116	0,960	0,375	0,680	0,160	0,387	0,041	0,250	0,014	0,174	0,007
0,820	3,175			4,093	11,619	3,136	6,073	1,756	1,485	1,122	0,499	0,792	0,215	0,451	0,054	0,290	0,018	0,204	0,009
1,009	3,629			4,679	14,878	3,584	7,777	2,009	1,903	1,283	0,640	0,905	0,276	0,518	0,070	0,335	0,025	0,235	0,011
1,135	4,082			5,264	18,505	4,033	9,673	2,259	2,366	1,442	0,796	1,018	0,341	0,582	0,088	0,375	0,029	0,262	0,014
1,262	4,536			5,849	22,494	4,481	11,757	2,512	2,877	1,603	0,967	1,134	0,416	0,643	0,106	0,418	0,036	0,293	0,016
1,388	4,990					4,929	14,026	2,761	3,431	1,765	1,153	1,247	0,495	0,710	0,127	0,460	0,045	0,323	0,018
1,514	5,443					5,377	16,480	3,014	4,032	1,923	1,354	1,359	0,583	0,777	0,149	0,503	0,052	0,351	0,023
1,640	5,897					5,825	19,113	3,264	2,416	2,085	1,571	1,472	0,676	0,841	0,174	0,543	0,061	0,381	0,025
1,766	6,350							3,514	5,363	2,246	1,803	1,585	0,775	0,905	0,199	0,585	0,068	0,411	0,029
1,892	6,804							3,767	6,095	2,405	2,048	1,701	0,879	0,969	0,226	0,628	0,079	0,439	0,034
2,208	7,938							4,395	8,109	2,807	2,726	1,984	1,171	1,134	0,301	0,732	0,104	0,512	0,043
2,523	9,072							5,023	10,385	3,206	3,489	2,268	1,498	1,295	0,384	0,838	0,133	0,588	0,057
2,839	10,206							5,651	12,916	3,609	4,339	2,551	1,865	1,457	0,479	0,914	0,165	0,661	0,070
3,154	11,34									4,011	5,275	2,835	2,267	1,618	0,581	1,049	0,201	0,735	0,086
3,469	12,474									4,410	6,294	3,118	2,705	1,780	0,694	1,152	0,240	0,808	0,102
3,785	13,608									4,813	7,392	3,402	3,178	1,942	0,814	1,256	0,283	0,881	0,120
4,100	14,742									5,212	8,574	3,685	3,686	2,106	0,945	1,362	0,328	0,954	0,138
4,416	15,876									5,614	9,836	3,968	4,226	2,268	1,085	1,466	0,375	1,027	0,158
4,731	17,010									6,017	11,178	4,252	4,803	2,429	1,232	1,573	0,427	1,103	0,181
5,046	18,144											4,535	5,413	2,591	1,388	1,676	0,481	1,177	0,203
5,362	19,278											4,819	6,057	2,752	1,553	1,780	0,538	1,250	0,228
5,677	20,412											5,102	6,733	2,914	1,727	1,887	0,599	1,323	0,253
5,993	21,546											5,386	7,442	3,075	1,907	1,990	0,662	1,396	0,280
6,308	22,680											5,669	8,183	3,240	2,097	2,097	0,728	1,469	0,307
6,939	24,948													3,563	2,504	2,304	0,868	1,618	0,366
7,570	27,216													3,886	2,940	2,515	1,022	1,765	0,432
8,200	29,484													4,212	3,410	2,725	1,184	1,911	0,499
8,831	31,752													4,535	3,912	2,935	1,358	2,057	0,574
9,462	34,020													4,859	4,445	3,146	1,544	2,207	0,651
10,093	36,288													5,185	5,010	3,353	1,738	2,353	0,735
10,724	38,556													5,508	5,607	3,563	1,946	2,499	0,823
11,354	40,824													5,831	6,233	3,773	2,163	2,649	0,913
11,985	43,092															3,984	2,391	2,795	1,010
12,616	45,360															4,194	2,628	2,941	1,110
14,193	51,030															4,718	3,270	3,310	1,381
15,770	56,700															5,243	3,973	3,679	1,679
17,347	62,370															5,767	4,741	4,045	2,002
18,924	68,040																	4,414	2,353
20,501	73,710																	4,782	2,728
22,078	79,380																	5,148	3,130
23,655	85,050																	5,517	3,555
25,232	90,720																	5,886	4,007
26,809	96,390																		
28,386	102,060																		
29,963	107,730																		
31,540	113,400																		
34,694	124,740																		
37,848	136,080																		

Note: Outlined area of chart indicates velocities over 1,5 m/s. Use with caution.

© Copyright 2000 Rain Bird

Velocity of flow values are computed from the general equation  $V = .408 \frac{Q}{d^2}$

Friction pressure loss values are computed from the equation:

$$hf = 0.2083 \left( \frac{100}{C} \right) 1.852 \frac{Q^{1.852}}{d^{4.866}} \times .098 \text{ for bar loss per 100 m of pipe}$$

## Technical Data

### Pressure loss in valves and fittings (in bars)

Equivalent length in meters of standard steel pipes								
Nominal pipe size	Globe valve	Angle valve	Sprinkler angle valve	Gate valve	Side outlet std. tee	Run of std. tee	Std. elbow	45° elbow
15 mm	5,18	2,74	0,61	0,12	1,22	0,30	0,61	0,30
20 mm	6,71	3,66	0,91	0,15	1,52	0,61	0,91	0,30
25 mm	8,23	4,57	1,22	0,18	1,83	0,61	0,91	0,61
32 mm	11,58	5,49	1,52	0,24	2,44	0,91	1,22	0,61
40 mm	13,72	6,71	1,83	0,30	3,00	0,91	1,52	0,61
50 mm	17,68	8,53	2,13	0,37	3,66	1,22	1,83	0,91
63 mm	21,34	10,67	2,74	0,43	4,27	1,52	2,13	0,91
75 mm	27,43	13,72	3,35	0,55	5,49	1,83	2,44	1,22
110 mm	36,58	18,29	4,57	0,70	7,01	2,13	3,35	1,52
160 mm	51,82	25,91	6,10	1,01	10,06	3,66	5,18	2,44

### Pressure loss through copper and bronze fittings (in bars)

Equivalent meters of straight tubing											
Nominal Tube Size	Wrought copper					Cast bronze					
	90° Elbow	45° Elbow	Tee Run	Tee Side Outlet	90° Bend	180° Bend	90° Elbow	45° Elbow	Tee Run	Tee Side Outlet	Compression Stop
10 mm	0,15	0,15	0,15	0,31	0,15	0,15	0,30	0,15	0,15	0,61	2,74
15 mm	0,15	0,15	0,15	0,31	0,15	0,31	0,30	0,31	0,15	0,61	3,96
17 mm	0,15	0,15	0,15	0,61	0,30	0,31	0,61	0,31	0,15	0,91	5,18
20 mm	0,30	0,15	0,15	0,61	0,30	0,61	0,61	0,31	0,15	0,91	6,40
25 mm	0,30	0,30	0,15	0,92	0,61	0,61	1,22	0,61	0,15	1,52	9,14
32 mm	0,61	0,30	0,15	1,23	0,61	0,92	1,52	0,61	0,30	2,13	—
40 mm	0,61	0,61	0,30	1,53	0,91	1,23	2,44	0,92	0,30	2,74	—
50 mm	0,61	0,61	0,30	2,15	1,22	2,45	3,35	1,53	0,61	3,66	—
63 mm	0,61	0,91	0,61	2,76	1,52	4,91	4,27	2,45	0,61	4,88	—
75 mm	0,91	1,22	—	—	2,13	6,14	5,49	3,37	0,61	6,10	—
90 mm	1,22	—	—	—	2,74	7,36	7,32	4,30	0,61	9,45	—
110 mm	—	—	—	—	—	8,59	8,53	5,22	0,61	11,28	—
130 mm	—	—	—	—	—	11,35	12,50	6,75	0,61	14,63	—
160 mm	—	—	—	—	—	14,42	15,85	8,59	0,61	18,59	—

Technical Data  
International System Units

### Climate PET

Climate	Millimeters Daily
Cool Humid	3 to 4 mm
Cool Dry	4 to 5 mm
Warm Humid	4 to 5 mm
Warm Dry	5 to 6 mm
Hot Humid	5 to 8 mm
Hot Dry	8 to 11 mm "worst case"

Cool = under 21° C as an average midsummer high  
 Warm = between 21° and 32° C as midsummer highs  
 Hot = over 32° C  
 Humid = over 50% as average midsummer relative humidity [dry = under 50%]

### Estimated service line sizes

Length of string	70 mm	83 mm	89 mm	10,2 cm	11,1 cm	12,7 cm
Size of service line copper	20 mm		25 mm		32 mm	
Size of service line galvanized		20 mm		25 mm		32 mm

### Pressure loss through swing check valves (in bars)

Flow L/s m <sup>3</sup> /h	Valve size						Flow L/s m <sup>3</sup> /h	Valve size					
	1/2	3/4	1	1 1/4	1 1/2	2		1 1/4	1 1/2	2	2 1/2	3	4
0,13 0,45	0,01	—	—	—	—	—	2,90 10,43	0,14	0,08	0,03	—	—	—
0,19 0,68	0,03	—	—	—	—	—	3,03 10,89	0,15	0,08	0,03	—	—	—
0,38 1,36	0,07	0,02	—	—	—	—	3,15 11,34	0,17	0,09	0,03	—	—	—
0,50 1,81	0,12	0,03	—	—	—	—	3,47 12,47	0,20	0,10	0,04	—	—	—
0,63 2,27	0,18	0,06	0,02	—	—	—	3,78 13,61	0,23	0,12	0,05	—	—	—
0,76 2,72	0,25	0,08	0,03	—	—	—	4,10 14,74	0,27	0,14	0,06	—	—	—
0,88 3,18	0,33	0,10	0,04	—	—	—	4,42 15,88	0,31	0,17	0,06	0,03	—	—
1,01 3,63	—	0,14	0,06	—	—	—	4,73 17,01	—	0,19	0,07	0,03	—	—
1,14 4,08	—	0,17	0,07	—	—	—	5,05 18,14	—	0,21	0,08	0,04	—	—
1,26 4,54	—	0,21	0,08	0,03	—	—	5,68 20,41	—	0,26	0,10	0,05	—	—
1,39 4,99	—	0,24	0,10	0,03	—	—	6,31 22,68	—	0,32	0,12	0,06	0,03	—
1,51 5,44	—	0,28	0,12	0,04	—	—	7,57 27,22	—	—	0,17	0,08	0,03	—
1,64 5,90	—	0,33	0,14	0,05	0,03	—	8,83 31,75	—	—	0,23	0,11	0,05	—
1,77 6,35	—	—	0,15	0,06	0,03	—	10,09 36,29	—	—	0,30	0,14	0,06	0,02
1,89 6,80	—	—	0,17	0,06	0,03	—	11,35 40,82	—	—	0,37	0,18	0,08	0,03
2,02 7,26	—	—	0,20	0,08	0,04	—	12,62 45,36	—	—	0,45	0,21	0,10	0,03
2,14 7,71	—	—	0,22	0,08	0,04	—	15,77 56,70	—	—	—	0,32	0,14	0,05
2,27 8,16	—	—	0,25	0,09	0,05	—	18,92 68,04	—	—	—	0,46	0,20	0,07
2,40 8,62	—	—	0,27	0,10	0,06	—	22,08 79,38	—	—	—	—	0,26	0,09
2,52 9,07	—	—	0,30	0,11	0,06	0,02	25,23 90,72	—	—	—	—	0,34	0,12
2,65 9,53	—	—	0,32	0,12	0,06	0,02	28,39 102,06	—	—	—	—	—	0,14

### Soil characteristics

SOIL TYPE	SOIL TEXTURE	SOIL COMPONENTS	INTAKE RATE	WATER RETENTION	DRAINAGE EROSION
Sandy soil	Coarse texture	Sand	Very high	Very low	Low erosion Good drainage
		Loamy sand	High	Low	
Loamy soil	Moderately coarse	Sandy loam	Moderately high	Moderately low	Low erosion Good drainage
		Fine loam	Moderately high	Moderately low	
	Medium texture	Very fine loam	Medium	Moderately high	Moderate drainage Moderate drainage Moderate drainage Moderate drainage
		Loam	Medium	Moderately high	
		Silty loam	Medium	Moderately high	
	Silt	Medium	Moderately high		
	Moderately fine	Clay loam	Moderately low	High	
Sandy clay loam		Moderately low	High		
Silty clay loam		Moderately low	High		
Clay soil	Fine texture	Sandy clay	Low	High	Drainage Severe erosion
		Silty clay	Low	High	
		Clay	Low	High	

Technical Data

Maximum precipitation rates

SOIL TEXTURE	MAXIMUM PRECIPITATION RATES: MILLIMETERS PER HOUR							
	0 to 5% slope		5 to 8% slope		8 to 12% slope		12%+ slope	
	cover	bare	cover	bare	cover	bare	cover	bare
Course sandy soils	51	51	51	38	38	25	25	13
Course sandy soils over compact subsoils	44	38	32	25	25	19	19	10
Light sandy loams uniform	44	25	32	20	25	15	19	10
Light sandy loams over compact subsoils	32	19	25	13	19	10	13	8
Uniform silt loams	25	13	20	10	15	8	10	5
Silt loams over compact subsoil	15	8	13	6	10	4	8	3
Heavy clay or clay loam	5	4	4	3	3	2	3	2

The maximum PR values listed above are as suggested by the United States Department of Agriculture. The values are average and may vary with respect to actual soil condition and condition of ground cover.

Friction loss characteristics of bronze gate valves (in bars) Slope reference

Bronze Gate Valves (loss in bar)		Valve Size (in inches)								
l/s	m <sup>3</sup> /h	1/2	3/4	1	1 1/4	1 1/2	2	2 1/2	3	4
0,069	0,227									
0,138	0,454	0,001								
0,345	1,134	0,004	0,001							
0,552	1,814	0,011	0,003	0,001						
0,690	2,268	0,017	0,006	0,002	0,001					
1,034	3,402		0,012	0,004	0,001	0,001				
1,379	4,536		0,021	0,008	0,002	0,001				
2,069	6,804			0,017	0,005	0,003	0,001			
2,758	9,072			0,030	0,009	0,005	0,001	0,007		
3,448	11,340			0,046	0,014	0,008	0,003	0,014		
4,137	13,608				0,021	0,010	0,003	0,021	0,001	
5,516	18,144				0,037	0,019	0,007	0,034	0,001	
6,895	22,680					0,030	0,010	0,048	0,002	
8,274	27,216					0,043	0,015	0,069	0,003	0,001
9,653	31,752					0,059	0,021	0,097	0,004	
11,032	36,288						0,028	0,124	0,005	0,002
12,411	40,824						0,034	0,159	0,006	
13,790	45,360						0,043	0,200	0,008	0,003
15,169	49,896							0,290	0,010	0,003
16,548	54,432								0,012	0,004
17,927	58,968								0,013	0,005
19,306	63,504								0,016	0,006
20,685	68,040								0,018	0,007
24,133	79,380								0,010	0,010
27,580	90,720								0,012	0,012
31,028	102,060								0,016	0,016
34,475	113,400								0,019	0,019
37,923	124,740								0,022	0,022
41,370	136,080								0,028	0,028

SLOPE REFERENCE CHART  
PERCENT, ANGLE AND RATIO

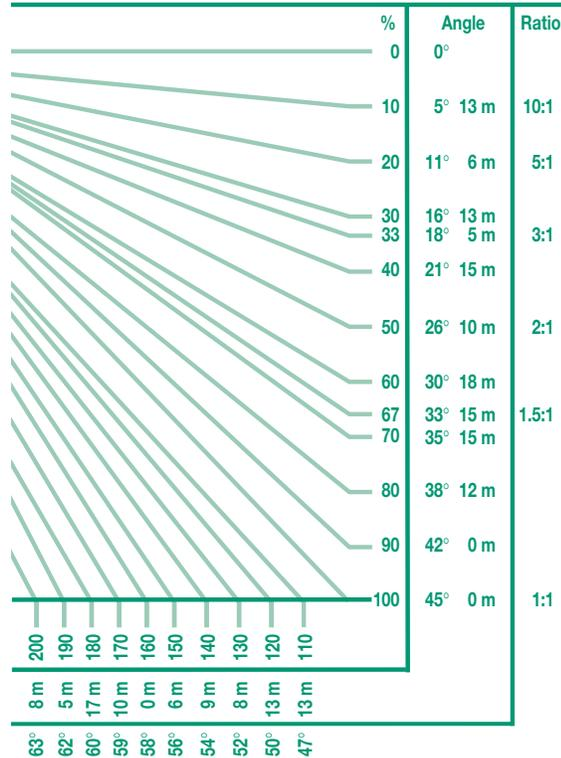

**Pressure loss through water meters  
AWWA standard pressure loss**

<b>Pressure loss: bar</b>									
<b>Nominal Size</b>									
<b>flow</b>									
<b>L/s</b>	<b>m<sup>3</sup>/h</b>	<b>18 mm</b>	<b>20 mm</b>	<b>25 mm</b>	<b>40 mm</b>	<b>50 mm</b>	<b>75 mm</b>	<b>110 mm</b>	
0,06	0,23	0,01	0,01						
0,13	0,45	0,02	0,01	-	-	-	-	-	
0,19	0,68	0,03	0,02	-	-	-	-	-	
0,25	0,91	0,04	0,03	0,01	-	-	-	-	
0,32	1,13	0,06	0,04	0,01	-	-	-	-	
0,38	1,36	0,09	0,05	0,02	-	-	-	-	
0,44	1,59	0,12	0,06	0,03	-	-	-	-	
0,50	1,81	0,16	0,07	0,03	-	-	-	-	
0,57	2,04	0,21	0,09	0,04	-	-	-	-	
0,63	2,27	0,26	0,11	0,05					
0,69	2,49	0,30	0,13	0,06					
0,76	2,72	0,35	0,15	0,06	-	-	-	-	
0,82	2,95	0,42	0,18	0,07	-	-	-	-	
0,88	3,18	0,50	0,21	0,08	-	-	-	-	
0,95	3,40	0,57	0,25	0,08					
1,01	3,63	0,65	0,28	0,10	0,03				
1,07	3,86	0,74	0,32	0,11	0,03	-	-	-	
1,14	4,08	0,83	0,36	0,12	0,04	-	-	-	
1,20	4,31	0,92	0,40	0,14	0,05	-	-	-	
1,26	4,54	1,03	0,45	0,15	0,06				
1,39	4,99		0,54	0,19	0,07				
1,51	5,44	-	0,66	0,23	0,08	-	-	-	
1,64	5,90	-	0,77	0,28	0,10	-	-	-	
1,77	6,35	-	0,90	0,32	0,11	-	-	-	
1,89	6,80		1,03	0,37	0,12				
2,02	7,26			0,41	0,14	0,06			
2,14	7,71	-	-	0,48	0,17	0,06	-	-	
2,27	8,16	-	-	0,54	0,19	0,07	-	-	
2,40	8,62	-	-	0,60	0,21	0,08	-	-	
2,52	9,07			0,66	0,23	0,09			
2,65	9,53			0,73	0,25	0,10			
2,78	9,98	-	-	0,81	0,27	0,10	-	-	
2,90	10,43	-	-	0,88	0,29	0,11	-	-	
3,03	10,89	-	-	0,96	0,31	0,12	-	-	
3,15	11,34			1,03	0,34	0,13	0,05		
3,28	11,79				0,37	0,14			
3,41	12,25	-	-	-	0,39	0,15	-	-	
3,53	12,70	-	-	-	0,43	0,16	-	-	
3,66	13,15	-	-	-	0,46	0,17	-	-	
3,78	13,61				0,50	0,19			
4,10	14,74				0,57	0,22	0,08		
4,42	15,88	-	-	-	0,68	0,26	0,09	-	
4,73	17,01	-	-	-	0,77	0,30	0,10	-	
5,05	18,14	-	-	-	0,88	0,34	0,11	0,05	
5,68	20,41	-	-	-	1,11	0,43	0,14	0,06	
6,31	22,68				1,38	0,54	0,17	0,06	
6,94	24,95					0,66	0,20	0,07	
7,57	27,22	-	-	-	-	0,78	0,23	0,08	
8,20	29,48	-	-	-	-	0,90	0,27	0,10	
8,83	31,75	-	-	-	-	1,04	0,31	0,11	
9,46	34,02					1,19	0,35	0,12	
10,09	36,29					1,38	0,40	0,14	
10,72	38,56	-	-	-	-	-	0,45	0,17	
11,35	40,82	-	-	-	-	-	0,50	0,19	
11,99	43,09	-	-	-	-	-	0,55	0,21	
12,62	45,36						0,62	0,22	
13,88	49,90						0,76	0,27	
15,14	54,43	-	-	-	-	-	0,90	0,32	
16,40	58,97	-	-	-	-	-	1,03	0,38	
17,66	63,50	-	-	-	-	-	1,19	0,43	
18,92	68,04						1,38	0,50	
22,08	79,38							0,69	
25,23	90,72	-	-	-	-	-	-	0,90	
28,39	102,06	-	-	-	-	-	-	1,12	
31,54	113,40	-	-	-	-	-	-	1,38	

Technical Data  
International System Units



*Appendix*

**a**

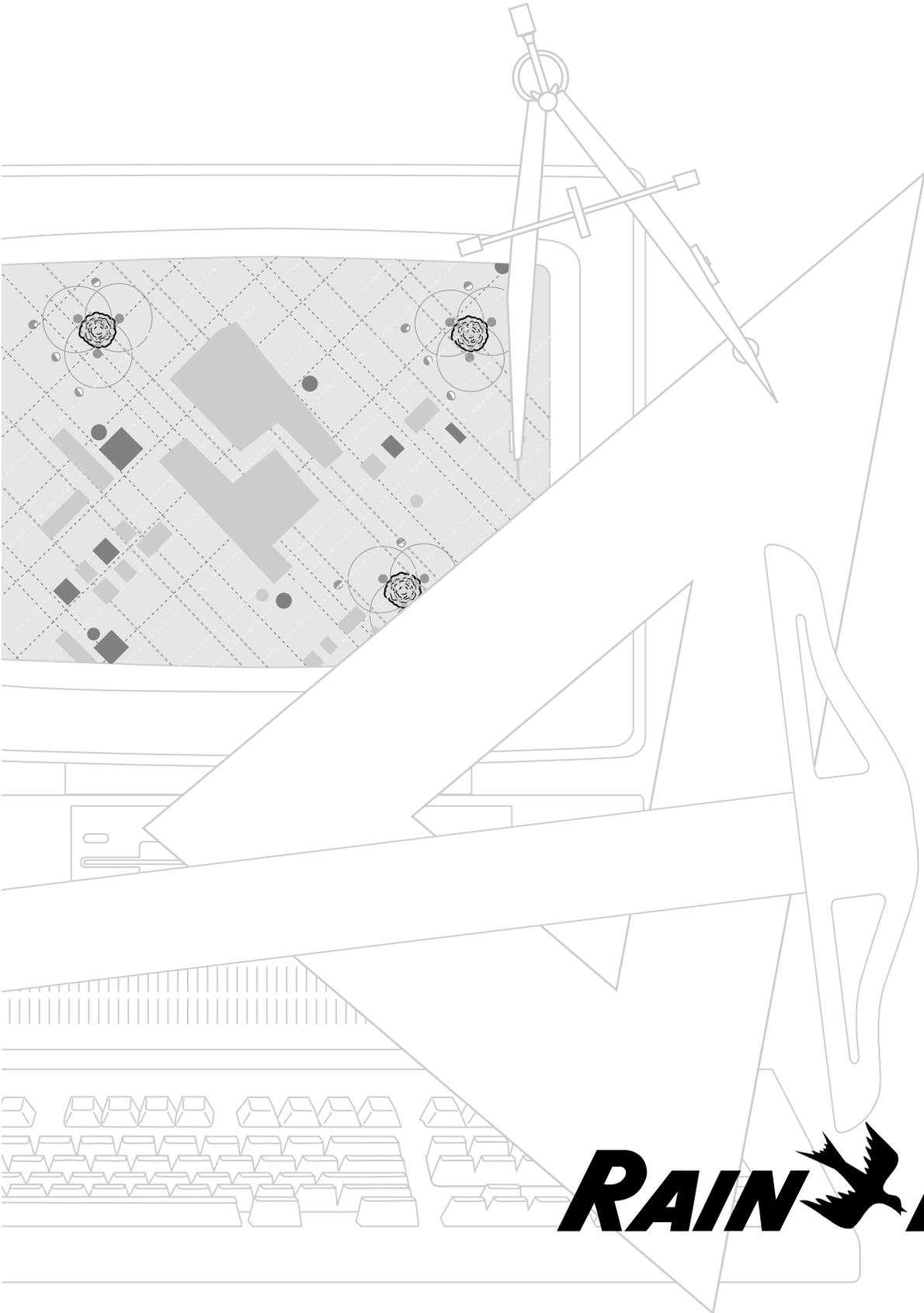

**RAIN  BIRD®**



### Table of formulas

Calculating water pressure (area is constant):

$$P = \frac{\text{force}}{\text{area}} = \frac{F}{A}$$

Calculating water flow (speed):

$$V = \frac{\text{gpm}}{2.45 \times \text{dia}^2} \left( V = \frac{1273,24 \times \text{L/s}}{\text{dia}^2} \right)$$

Calculating daily average operating time:

$$OT = \frac{1 \times 60}{PR \times DA}$$

Calculating pressure needed to operate the system:

$$PR = PS - (Po + Pls)$$

Calculating a circuit's F factor:

$$F = \frac{\text{allowable voltage drop}}{\text{amps/control unit} \times \text{equivalent length in thousands of feet (meters)}}$$

Calculating precipitation rates:

$$PR = \frac{96.3 \times \text{gpm (applied to the area)}}{S \times L} \left( PR = \frac{1000 \times \text{m}^3/\text{h [applied to the area]}}{S \times L} \right)$$

**Table of figures**

Figure 1: Water towers filled at 12 in and 24 in (50 cm and 100 cm) ..... 3

Figure 2: Water tower – 200 ft (100 m) ..... 4

Figure 3: Water supply to a house ..... 4

Figure 4: Static water pressure ..... 5

Figure 5: Water path with friction ..... 6

Figure 6: Large flow, small valve, lower pressure ..... 6

Figure 7: Schedule 40 PVC pipe friction loss characteristics (partial) ..... 7

Figure 8: Class 200 PVC pipe friction loss characteristics (partial) ..... 8

Figure 9: Basic plan drawing ..... 15

Figure 10: More detailed plan drawing ..... 16

Figure 11: Soil characteristics ..... 20

Figure 12: Soil/water/plant relationship ..... 20

Figure 13: Soil infiltration and wetting pattern for drip irrigation ..... 21

Figure 14: Determining the soil type ..... 21

Figure 15: Maximum precipitation rates for slopes ..... 21

Figure 16: Slope reference ..... 22

Figure 17: Faucet with pressure gauge ..... 27

Figure 18: Estimated service line sizes ..... 27

Figure 19: Pressure loss from water main to water meter ..... 27

Figure 20: Pressure loss through water meters (partial) ..... 28

Figure 21: Type K copper pipe friction loss characteristics (partial) ..... 29

Figure 22: Water main, water meter, POC and service line ..... 29

Figure 23a: Bronze gate valves friction loss characteristics (U.S. Standard Units) ..... 31

Figure 23b: Bronze gate valves friction loss characteristics (International System Units) ..... 31

Figure 24: Avoid mixing sprinkler heads on each valve ..... 35

Figure 25: Matched precipitation rate sprinklers ..... 36

Figure 26: Spray sprinklers ..... 36

Figure 27: Rotating sprinklers ..... 37

Figure 28: Bubbler ..... 37

Figure 29: Emitter device ..... 38

Figure 30: Multi-outlet emitter device ..... 38

Figure 31a: Nozzle performance (U.S. Standard Units) ..... 39

Figure 31b: Nozzle performance (International System Units) ..... 39

Figure 32: Measuring sprinkler distribution with containers ..... 41

Figure 33: Sprinkler water distribution graph ..... 41

Figure 34: 60% sprinkler radius ..... 41

Figure 35: 60% diameter sprinkler spacing ..... 41

Figure 36: 50% sprinkler head spacing ..... 42

Figure 37: Square sprinkler spacing pattern ..... 42

Figure 38: Square sprinkler spacing pattern weak spot ..... 42

Figure 39: Triangular sprinkler spacing pattern ..... 42

Figure 40: S and L triangular sprinkler spacing pattern ..... 43

Figure 41: Staggered sprinkler spacing pattern . . . . .	43
Figure 42: Sliding pattern . . . . .	43
Figure 43: Square sprinkler spacing pattern with full circle sprinkler . . . . .	44
Figure 44: Square sprinkler spacing pattern with part circle sprinkler . . . . .	45
Figure 45: PR calculation for four spray heads . . . . .	45
Figure 46: Calculating triangular sprinkler spacing . . . . .	45
Figure 47: Calculating the PR for triangular sprinkler spacing patterns . . . . .	46
Figure 48: Sprinkler pattern for shrubs and trees . . . . .	48
Figure 49: Sprinkler pattern for hedges . . . . .	48
Figure 50: Plan, locating sprinklers . . . . .	50
Figure 51: Plan, alternate backyard . . . . .	51
Figure 52: Plan, lateral layout . . . . .	56
Figure 53: Straight line lateral valve configurations . . . . .	57
Figure 54: Split-length lateral configurations . . . . .	57
Figure 55: Two row sprinkler circuits . . . . .	58
Figure 56: Deep U-shape circuits . . . . .	58
Figure 57: Odd number circuits, example one . . . . .	58
Figure 58: Odd number circuits, example two . . . . .	58
Figure 59: Main line/lateral line configuration . . . . .	58
Figure 60: Main line and lateral line . . . . .	60
Figure 61: Plan, valve groups . . . . .	61
Figure 62: Lateral pipe configuration . . . . .	65
Figure 63: Class 200 PVC pipe friction loss characteristics (partial) . . . . .	66
Figure 64: Lateral pipe configuration . . . . .	66
Figure 65: Piping plan . . . . .	66
Figure 66: Remote control valve . . . . .	67
Figure 67: PVC Schedule 40 friction loss characteristics (partial) . . . . .	68
Figure 68a: Valve pressure loss PEB series (U.S.Standard measure) . . . . .	68
Figure 68b: Valve pressure loss PEB series (International System Units) . . . . .	68
Figure 69: Pressure vacuum breaker . . . . .	69
Figure 70: Pressure vacuum breaker flow loss . . . . .	69
Figure 71: Worst case circuit . . . . .	70
Figure 72: Sample plan with rotor pop-ups . . . . .	70
Figure 73: Valve control wire network . . . . .	75
Figure 74: Sizing field valve wires . . . . .	76
Figure 75a: Wire sizing for 24 VAC solenoid valves (U.S. Standard Units) . . . . .	77
Figure 75b: Wire sizing for 24 VAC solenoid valves (International System Units) . . . . .	77
Figure 76: Two controllers with wire runs at different locations . . . . .	78
Figure 77: Electrical current requirements of controllers and valves . . . . .	79
Figure 78: Wires size and F factor . . . . .	79
Figure 79: Irrigation legend . . . . .	83
Figure 80: Final irrigation plan . . . . .	84



# Index

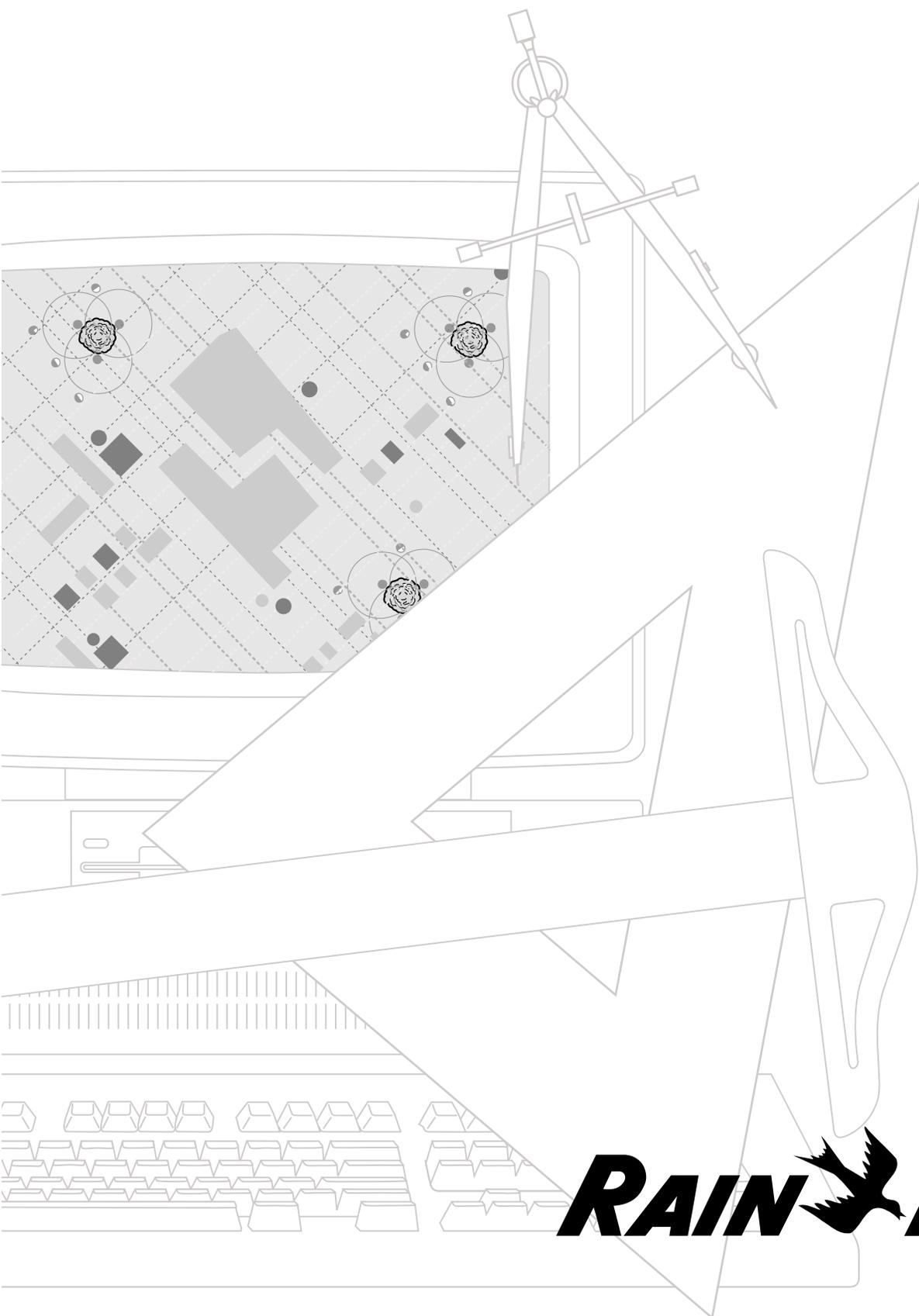

**RAIN  BIRD®**



## Index

### A

American Society of Irrigation Consultants ..... 86  
 angle of slope..... 21  
 arc, sprinkler ..... 38  
 available  
   flow..... 27  
   water (AW) ..... 21  
 AW (available water)..... 21

### B

backflow prevention device ..... 68  
 backflow, definition ..... 66  
 bubblers ..... 35, 37

### C

capillary  
   action..... 20  
   water ..... 20  
 Center for Irrigation Technology ..... 41  
 circuiting sprinklers ..... 55  
   exercises ..... 62  
 CIT (Center for Irrigation Technology) .. 41  
 climate PET chart..... 19, 103, 116  
 controller, locating ..... 75  
 critical circuit length, definition ..... 65

### D

diameter of throw, sprinkler ..... 38  
 distribution rate curve..... 41  
 DRC (distribution rate curve)..... 41  
 drip irrigation  
   devices..... 35, 37  
   zone ..... 55  
 dynamic water pressure ..... 6

### E

elevation ..... 3  
 emitters..... 37  
 equivalent circuit length, calculating ... 76  
 ET (evapotranspiration) ..... 19  
 ETo (reference evapotranspiration) .... 19  
 evapotranspiration..... 19  
 evapotranspiration, reference ..... 19

### F

F factor, calculating ..... 79  
 fan spray sprinklers ..... 36  
 feet of head  
   definition..... 3  
   formula ..... 4  
 field capacity ..... 20  
 flow loss chart, water meter ..... 27  
 flow, available ..... 27  
 formulas  
   F factor ..... 79, 123  
   feet of head..... 4  
   operating time..... 58, 123  
   precipitation rate..... 123  
   system pressure requirement .. 70, 123  
   table of..... 123  
   velocity..... 6  
   water flow (speed)..... 123  
   water pressure ..... 3, 123  
 friction loss, characteristics  
   international system units  
     bronze gate valves ..... 118  
     polyethylene (PE) SDR-  
     pressure-rated tube ..... 113  
     PVC class 125 IPS plastic pipe .. 112  
     PVC class 160 IPS plastic pipe .. 111  
     PVC class 200 IPS plastic pipe .. 110  
     PVC class 315 IPS plastic pipe .. 109  
     PVC schedule 40 IPS plastic  
     pipe ..... 108  
     PVC schedule 80 IPS plastic  
     pipe ..... 107  
     schedule 40 standard steel  
     pipe ..... 114  
     type K copper water tube .... 115  
   U.S. standard units  
     bronze gate valves ..... 105  
     polyethylene (PE) SDR-  
     pressure-rated tube ..... 100  
     PVC class 125 IPS plastic pipe .. 99  
     PVC class 160 IPS plastic pipe .. 98  
     PVC class 200 IPS plastic pipe .. 97  
     PVC class 315 IPS plastic pipe .. 96  
     PVC schedule 40 IPS plastic  
     pipe ..... 95  
     PVC schedule 80 IPS plastic  
     pipe ..... 94  
     schedule 40 standard steel  
     pipe ..... 101  
     type K copper water tube .... 102  
 friction loss, definition..... 6

### G

gallons per minute ..... 6  
 gpm (gallons per minute) ..... 6  
 gravitational water ..... 20

### H

head-to-head sprinkler spacing..... 41  
 hydraulics  
   definition..... 3  
   exercises ..... 9  
   understanding ..... 3  
 hydrodynamic, definition ..... 4  
 hydrostatic, definition ..... 4  
 hygroscopic water..... 20

### I

impact sprinklers ..... 35, 37  
 impulse sprinklers ..... 35  
 irrigation plan  
   exercises ..... 85  
   preparing the final ..... 83  
 irrigation requirements  
   determining ..... 19  
   exercises ..... 23

### L

L/s ..... 6  
 lateral  
   layout ..... 55  
   lines ..... 60  
   operating time, calculating ..... 58  
   piping, locating ..... 57  
 lateral circuits  
   deep “U” shape ..... 58  
   odd number ..... 58  
   split length ..... 57  
   straight line..... 57  
 layout, lateral..... 55  
 liters per second ..... 6

## Index

### M

- m3/h ..... 6
- main line..... 60
  - locating ..... 57
  - sizing ..... 67
- maximum
  - flow, water meter ..... 28
  - precipitation rates for slopes... 21, 105, 118
  - velocity of flow ..... 28
  - wetted diameter..... 21
  - wetting patterns..... 20
- meters cubed per hour (m3/h) ..... 6
- meters of head
  - definition..... 3

### O

- operating time
  - calculating ..... 58
  - exercises ..... 62
  - formula ..... 58

### P

- pattern of coverage..... 38
- permanent wilting point ..... 20
- pipe, sizing ..... 65
- POC (point-of-connection) ..... 5, 29
- point-of-connection ..... 5, 29
- pop-up gear drive sprinklers ..... 35
- pop-up spray sprinklers ..... 35, 36
- pounds per square inch, definition..... 3
- power supply, determining..... 27
- power wires, sizing..... 75, 78
- precipitation rates
  - calculating ..... 41, 44
  - exercises ..... 47
  - sprinkler ..... 38
- pressure vacuum breaker ..... 68
- psi (pounds per square inch), definition . 3

### R

- radius, sprinkler ..... 38
- reference evapotranspiration ..... 19
- references ..... 86
- remote control valve ..... 67
- rotating sprinklers ..... 35, 36

### S

- scaled drawing ..... 13
- scheduling coefficient ..... 41
- selecting
  - spacing ranges ..... 35
  - sprinklers ..... 35
  - sprinklers, exercises ..... 40
- service line..... 27, 103, 116
- short radius devices ..... 35
- shrub spray sprinklers..... 35, 36
- site information
  - exercises ..... 23
  - obtaining..... 13
- site plan ..... 13
- slope reference chart ..... 22, 105, 118
- slope, angle of ..... 21
- slopes, maximum precipitation rates... 21
- soil type..... 19
- solutions to exercises ..... 89
- spacing ranges, selecting..... 35
- spacing sprinklers..... 41
  - exercises ..... 47
  - percentage of the diameter ..... 38
- spray sprinklers..... 35, 36
- sprinkler precipitation rate ..... 38
- sprinkler spacing patterns
  - adjusting for wind velocities ..... 42
  - rectangular ..... 43
  - sliding ..... 43
  - square ..... 42
  - staggered..... 43
  - triangular ..... 42
- sprinklers
  - circuiting into valve groups..... 55
  - locating on a plan ..... 48
  - locating, exercises ..... 52
  - selecting ..... 35
  - spacing ..... 41
- static water pressure..... 3, 4
- system electrics, exercises..... 85
- system pressure requirements
  - exercises ..... 71
  - formula ..... 69

### T

- table of figures..... 124
- technical data ..... 94

### U

- ultra-low volume devices ..... 35

### V

- valve groups, circuiting sprinklers into . 55
- valve wires, sizing ..... 75
- valves
  - locating ..... 57
  - remote control ..... 67
  - sizing ..... 65
- VAN (variable arc nozzle) ..... 36
- variable arc nozzle ..... 36, 49
- velocity
  - definition..... 6
  - formula ..... 6
  - of flow, maximum ..... 28

### W

- water
  - capillary..... 20
  - gravitational ..... 20
  - hygroscopic ..... 20
- water capacity, exercises ..... 30
- water meter
  - capacity..... 27
  - flow loss chart ..... 27, 106, 119
  - maximum flow..... 28
  - size ..... 27
- water pressure
  - determining, exercises ..... 30
  - dynamic..... 6
  - requirements ..... 65
  - static..... 3
- water supply, determining ..... 27
- water window, definition..... 59
- working pressure, calculating ..... 27, 29

### Z

- zero radius devices..... 35, 37





**Rain Bird Corporation, Commercial Division**

6951 E. Southpoint Rd.  
Tucson, AZ 85706 USA  
Tel (520) 741-6100  
Fax (520) 741-6146

**Rain Bird International, Inc.**

145 North Grand Avenue  
Glendora, CA 91741 USA  
Tel (626) 963-9311  
Fax (626) 963-4287

**Rain Bird Technical Service**

(800) 247-3782 (800-BIRD-SVC)  
(USA and Canada only)

**Specifications Hotline**

(800) 458-3005 (USA and Canada only)

Recycled paper.  
Rain Bird. Conserving more than water.

© Registered Trademark of Rain Bird Sprinkler Mfg. Corp.  
© 2001 Rain Bird Sprinkler Mfg. Corp. 3/01

[www.rainbird.com](http://www.rainbird.com)

D38470B